

SURAT MUNICIPAL CORPORATION

SLUM UPGRADATION DEPARTMENT



NAME OF WORK: Development of Integrated Group Housing Facility at T. P. Scheme No. 7 (Anjana), F.P. No. 191 Gandhinagar, Chimni Tekro , Juno Depo & Islampura & F.P. No 45 , Javaharnagar , Nehrunagar , Salimnagar , Gousiya Masjid, Anjana at Surat on Public Private Partnership (PPP) basis under Mukhya Mantri Gruh Yojana(Work No.1)

E- Tender

TENDER NOTICE NO : DC/SUC/12/2016-17

VOLUME-I :

PROJECT INFORMATION MEMORANDUM

SERIAL NO. OF THE WORK	:	1
DOWNLOADING OF TENDER DOCUMENTS STARTS FROM	:	Dt. 04/03/2017
Online submission of queries	:	through e-mail before Dt. 15/03/2017 up to 17.00 hrs.
Pre-Bid Meeting	:	Dt. 17/03/2017 up to 11.00 hrs.
LAST DATE OF DOWNLOAD OF TENDER DOCUMENTS FROM website smc.nprocure.com	:	Dt. 06/04/2017 upto 17.00 hrs
LAST DATE OF SUBMISSION OF ONLINE TENDER	:	Dt. 06/04/2017 upto 18.00 hrs
LAST DATE OF SUBMISSION OF TENDER FEES, EMD AND OTHER DOCUMENTS IN HARD COPY	:	During Dt. 07/04/2017 to 13/04/2017 upto 17.00 hrs
ESTIMATED AMOUNT	:	Rs. 216,00,00,000.00



Surat Municipal Corporation

Tender Notice (On line) No. DC/SUC/12/2016-17

On line tender consisting of Post-Qualification, Technical & Price Bid duly super scribed are invited from Reputed Developers for Development of Integrated Group Housing Facility at T. P. Scheme No. 7 (Anjana), F.P. No. 191 Gandhinagar, Chimni Tekro , Juno Depo & Islampura & F.P. No 45 , Javaharnagar , Nehrunagar , Salimnagar , Gousiya Masjid, Anjana at Surat on Public Private Partnership (PPP) basis under Mukhya Mantri Gruh Yojana (Work No.1) so as to reach "Chief Accountant, Accounts Department, Surat Municipal Corporation, Muglisara, Surat-395003." on or before the date mentioned below.

Tender Notice No.	(On line) No. DC /SUC/12/2016-17	
Organization Name	SURAT MUNICIPAL CORPORATION	
Department Name	SLUM UPGRADATION DEPARTMENT	
Name of Work	Development of Integrated Group Housing Facility at T. P. Scheme No. 7 (Anjana), F.P. No. 191 Gandhinagar, Chimni Tekro , Juno Depo & Islampura & F.P. No 45 , Javaharnagar , Nehrunagar , Salimnagar , Gousiya Masjid, Anjana at Surat on Public Private Partnership (PPP) basis under Mukhya Mantri Gruh Yojana (Work No.1)	
Tender Type	(On line) Open -	
Bidder Nationality	NCB	
Product	Building work	
Type of Contract	Single Work	
Bidding Currency	Single- Indian National Rupees.	
Joint Venture	As per RFP	
Registration Class	"AA" class Experienced & Financially Sound Developers / Contractors	
Schedule of E-Tender	Downloading of Tender Documents	04/03/2017 to Dt.06/04/2017 up to 18:00 hrs.
	Pre-Bid Meeting	Bidders shall have to post their queries on E-Mail address slumupgradation@gmail.com on or before 15/03/2017 Time upto 17:00 Hrs. Pre Bid meeting will be held on Dt.17/03/2017. @ 11.00 hrs.

		Place of Pre bid meeting : 88,Conference hall 2 nd Floor, SMC office, Mugalisara, Surat. Gujarat, India.
	Last date of online submission of Tender documents (PQ supporting documents, submission of eligibility & qualification documents duly signed & notarized (technical bid inclusive of corringdum if any), scan copy of DD of EMD & tender/Bid fees along with duly filled & duly signed forms and Price Bid) :-	Shall be submitted online on or before Dt. 06/04/2017 up to 18:00 hrs.
	Submission of Tender fee, EMD (original) and Technical Pre Qualifying Documents (Physical Submission only)	Between Dt.07/04/2017 to Dt. 13/04/2017 up to 17:00 Hrs. at the office of “Chief Accountant, Account Department, Surat Municipal Corporation, Muglisara, Surat – 395003 by Speed Post / RPAD only.” In sealed cover duly super scribed with name of work and tender notice no.
	Opening of Technical Bid along with Eligibility and Qualification Submissions documents (i.e online Opening of uploaded Documents)	If possible on Dt. 15/04/2017 at 16:00 hrs.
	Opening of Price Bid, (Online)	INTIMATED LATER (ON LINE)
	Bid validity period	180 days from the date of opening of price bid.
	Project Completion	As mentioned in RFP
Payment Details	Bid/ Document Fee	Rs.18,000/- In form of Demand Draft payable in favour of “The Commissioner, Surat Municipal Corporation”. Payable at Surat only. This Demand Draft shall be from any Nationalized/Scheduled Banks.
	EMD (BID SECURITY)	Rs. 2,16,00,000.00 (hereinafter referred to as “Bid Security” or “EMD”) The Earnest Money Deposit is to be deposited as mentioned in RFP in favour of The Commissioner, Surat Municipal Corporation, Payable at Surat. The 50% EMD amount shall be deposited in form of Demand Draft and remaining 50% EMD

		<p>amount shall be in form of Bank Gurantee, only from any Nationalized/Scheduled Banks.</p>
<p>General Terms & Conditions</p>	<p>Bidders who wish to participate in this E-Tender will have to procure valid digital certificate as per information Technology Act. 2000. Bidders can procure this certificate from any of the Government approved certifying agency i.e. (n) Code Solution. Bidders shall upload the tender documents after submitting the DD details for tender fees and EMD details online. The Demand Draft toward Tender Document fees can be submitted along with Earnest Money Deposit before the due date as specified above. This should be as per details given online and it should be drawn before last date of the uploading of the tender. The intending bidders shall have to submit the following documents along with the EMD (BID SECURITY). The Bidder should submit all the forms electronically only. The Bidder should submit all the forms electronically and Submission of Tender fee, EMD and all necessary documents mentioned in technical bid etc. in hard copy. SMC shall not be responsible for any postal delay.</p> <p>DOWNLOAD OF TENDER DOCUMENT :</p> <p>The tender document for these work are available only in Electronic format which can be downloaded free of cost by the bidder.</p> <p>SUBMISSION OF TENDER :</p> <p>Bidder shall submit their offer in electronic format on https://smc.nprocure.com website on or before the scheduled date and time as mentioned, after Digitally Signing the same. Price bid in physical form will not be accepted and any such offer if received by SURAT MUNICIPAL CORPORATION will be out rightly rejected. Bidder shall have to submit separate account payee DD for Tender Fee & EMD drawn in favour of Commissioner, Surat Municipal Corporation, Surat.</p>	
	<p>OPENING OF TENDER:-</p> <p>The Tender Bids will be opened on the specified date & venue. Bidders who wish to remain present at Surat Municipal Corporation office, at the time of tender opening can do so. Only one representative of each firm will be allowed to remain present.</p>	
<p>Information for online participation</p>	<p>(a) Internet site address for e-Tendering activities will be https://smc.nprocure.com</p> <p>(b) Interested bidders can view detailed tender notice and download tender document from the above mentioned website.</p> <p>(c) Bidders who wish to participate in online tender have to register with the website through the "New User Registration" link provided on the home page. Bidder will create login id & password of their own in registration process.</p> <p>(d) Bidders who wish to participate in this tender need to procure Digital Certificate as per Information Technology Act-2000 using that they can digitally sign their electronic bids. Bidders can procure the same from any of the CCA approved certifying agencies, or they may contact (n) code Solution at below mentioned address and they will assist them in procuring the same. Bidders who already have a valid Digital Certificate</p>	

	<p>need not to procure the same. In case bidders need any clarification regarding online participation, they can contact M/s (n)code solution</p> <p>301, G.N.F.C. Info Tower, Near Grant Bhagwati Hotel, Ahmedabad 380 015 INDIA</p> <p>Tel: +91 79 26857316 Tel: +91 79 26857317 Tel: +91 79 26857318</p> <p>e-Mail:</p> <p>URL: https://smc.nprocure.com</p> <p>(e) Bidders who wish to participate in e-Tender need to fill data in predefined forms of tender fee, EMD, Technical Bid of tender i.e. PQ (Technical) Or experience details and Price bid only.</p> <p>(f) Bidder should upload scan copies of reference documents in support of their eligibility of the bid.</p> <p>(g) After filling data in predefined forms bidders need to click on final submission link to submit their encrypted bid. Bidder can also submit Document Fees, EMD, Volumes of tender document & Reference Documents as instructed by tendering authority.</p>
--	--

Deputy Municipal Commissioner,
Surat Municipal Corporation

**TENDER TO BE SUBMITTED TO:
THE CHIEF ACCOUNTANT,
SURAT MUNICIPAL CORPORATION, MUGLISARA
SURAT – 395 003.
BY R.P.A.D. / THROUGH POSTAL AUTHORITY / SPEED POST ONLY**

**NAME OF WORK :- Development of Integrated Group Housing Facility at T. P. Scheme No. 7
(Anjana), F.P. No. 191 Gandhinagar, Chimni Tekro , Juno Depo &
Islampura & F.P. No 45 , Javaharnagar , Nehrunagar , Salimnagar ,
Gousiya Masjid, Anjana at Surat on Public Private Partnership (PPP) basis
under Mukhya Mantri Gruh Yojana(Work No.1)**

e-TENDER (Online) NOTICE NO. : DC/SUC/12/2016-17

WORK NO. 1

Last date of submission of online Tender :

On or before Dt.(06/04/2017) up to 18.00 hrs

**Last date of submission of All necessary documents mentioned in Technical bid (Volume-I)
(if any), Tender Fees, EMD and Other Documents in Hard Copy :**

From Dt. 07/04/2017 to Dt.13/04/2017 up to 17:00 hrs at the office of Chief
Accountant, Surat Municipal Corporation, Muglisarai, Surat- 395 003.

Earnest Money : **Rs. 2,16,00,000.00** should be paid in the form of Demand Draft
of any Nationalized/ Scheduled Banks, payable at Surat only.

OR

50% amount shall be in the form of Demand Draft and 50 %
amount Shall be in the form of Bank guarantee of Nationalized/ Scheduled
Banks, payable at Surat only.

Tender Fee : **Rs. 18,000.00** should be paid shall be in the form of Demand
Draft of Nationalized/ Scheduled Banks, payable at Surat only.

Pre-Bid : Bidders shall have to post their queries on e-mail address
slumupgradation@gmail.com before Dt. 15/03/2017 upto 17:00 hrs.

EXECUTIVE ENGINEER
SLUM UPGRADATION DEPARTMENT
SURAT MUNICIPAL CORPORATION

SIGNATURE OF THE CONTRACTOR / DEVELOPERS

DATE :

NAME AND ADDRESS :-

[TECHNICAL -BID]

NAME OF WORK : Development of Integrated Group Housing Facility at T. P. Scheme No. 7 (Anjana), F.P. No. 191 Gandhinagar, Chimni Tekro , Juno Depo & Islampura & F.P. No 45 , Javaharnagar , Nehrunagar , Salimnagar , Gousiya Masjid, Anjana at Surat on Public Private Partnership (PPP) basis under Mukhya Mantri Gruh Yojana(Work No. 1)

Estimated Amount :- Rs. 216,00,00,000.00

E.M.D. :- Rs. 2,16,00,000.00

Tender Fee :- Rs. 18000.00

Receipt No. :- _____

Date :- _____

Issued to

CONTRACTOR _____

**Issuing Office : Executive Engineer, Slum Upgradation Department,
Old Rander Zone Office, Tadwadi, Rander Road,
Surat Municipal Corporation,
Surat.**

Signature & Date of the Issuing Officer :-

**Executive Engineer
Slum Upgradation Department
Surat Municipal Corporation.**

SIGNATURE OF THE CONTRACTOR.

DATE :

NAME AND ADDRESS :-

Work no. 1

Name Of Work:-

Development of Integrated Group Housing Facility at T. P. Scheme No. 7 (Anjana), F.P. No. 191 Gandhinagar, Chimni Tekro , Juno Depo & Islampura & F.P. No 45 , Javaharnagar , Nehrunagar , Salimnagar , Gousiya Masjid, Anjana at Surat on Public Private Partnership (PPP) basis under Mukhya Mantri Gruh Yojana(Work No.1).

Sr.no	Description	Page No
1	Volume-1	11 to 39
2	Volume-2	40 to 102
3	Volume-3	103 to 133
4	Volume-4	134 to 211



(1) Indicative model layout on google image.

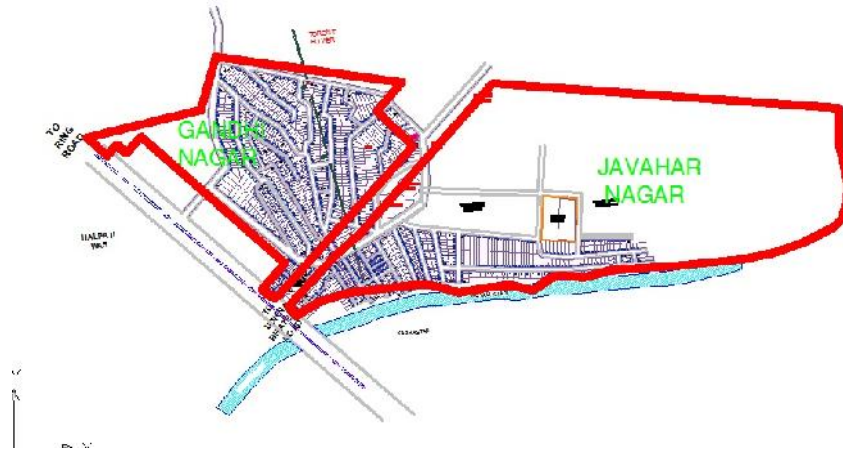

(2) Indicative schematic existing slum drawing of slum

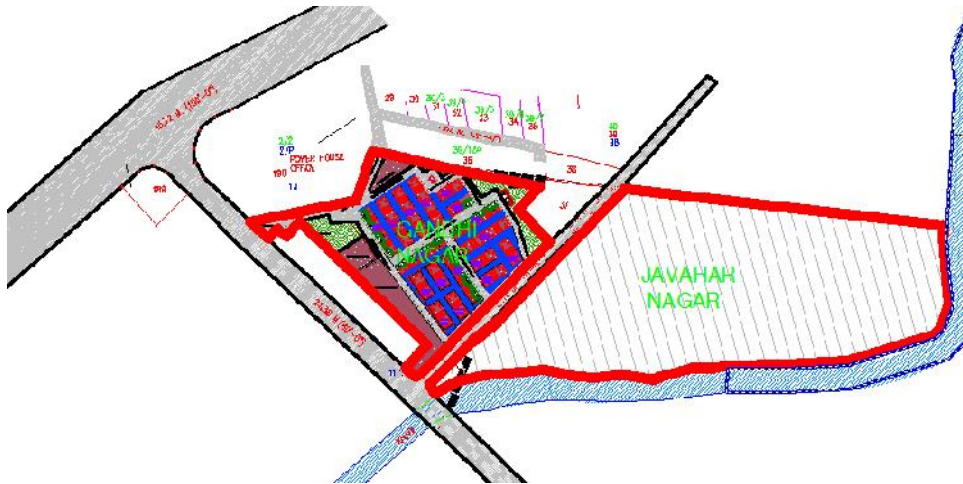

(3) Indicative cluster plan of integrated group housing facility.

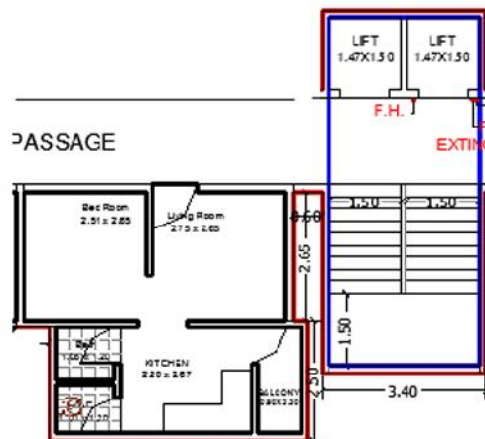

(4) Indicative unit plan of dwelling unit.

CONTENTS		
Sr.No.	Particulars	Page No.
	Volume-I : Project Information Memorandum	
1.	DISCLAIMER.	12
2.	ABBREVIATIONS.	13
3.	SCHEDULE OF BIDDING PROCESS.	14
4.	PROJECT DEVELOPMENT & BIDDING PROCESS.	14
5.	INTRODUCTION.	15
6.	SITE APPRECIATION.	16
7.	DEVELOPMENT CONTROL REGULATIONS	18
8.	APPENDICES.	18
9.	GENERAL INFORMATION.	19

Volume - I

PROJECT INFORMATION MEMORANDUM

DISCLAIMER

Though adequate care has been taken in the preparation of this Request for Proposal (Hereinafter referred to as “RFP”) document, the Bidders should satisfy themselves that the document is complete in all the respect and the information provided is correct. In case of discrepancy, if any, intimation should be given to the Officer Concerned in **Surat Municipal Corporation** (whose contact details is mentioned in this document) immediately on or before the due date specified in the Schedule of Bidding Process. If no intimation is received by the said officer within the date as mentioned in Schedule of Bidding Process as mentioned in this Document, it shall be deemed that the bidder is satisfied that the RFP document is complete in all respects.

Neither **SURAT MUNICIPAL CORPORATION** (hereinafter referred to as “SMC”) nor their employees or Project Consultants make any representation or warranty as to the accuracy, reliability or completeness of the information in this RFP and it is not possible for SMC to consider the investment objectives, financial situation and Particular needs of each party who reads or uses this RFP concerning the project. Certain prospective bidders may have better knowledge of the project compared to the others and SMC encourages all the prospective bidders to conduct their own due diligence, investigations & analysis and check for accuracy, reliability and completeness of this RFP. The bidders are free to obtain the independent advice from the sources appropriate to them.

Neither SMC nor their employees or Project Consultants will have any liability to any Prospective bidder or any other person under the law of contract, tort, the principles of Restitution or unjust enrichment or otherwise for any loss, expenses or damage which may arise from or to be incurred or suffered in connection with anything contained in this RFP, any matter deemed to form part of this RFP, the award of the project, the information and any other information supplied by or on behalf of SMC or their employees or their consultant or otherwise arising in any way from the selection process of this project.

SMC reserves the right to reject any or all of the bids submitted in response to this RFP at any stage without assigning any reasons whatsoever. SMC also reserves the right to hold or withdraw or cancel the process at any stage under intimation to the bidders, who submit the RFP, without assigning any reasons whatsoever.

SMC reserves the right to modify or amend or add to any or all of the provisions of this RFP Document or annul the present process. Such change would be intimated to all the parties procuring this RFP.

Neither SMC nor their employees or Project Consultants will have any liability in case of non-receipt of any correspondence from them to the bidders due to the postal delays.

The Applicable law for the purpose is the laws in India. Civil Courts of **Surat city** will have jurisdiction over the matter concerning and arising out of this RFP.

ABBREVIATIONS.

PPP	Public Private Partnership
SMC	Surat Municipal Corporation
Eoi	Expression of Interest
RfQ	Request for Qualification
RFP	Request For Proposal
IE	Independent Engineer
LOA	Letter of Award
SPV	Special Purpose Vehical
INR	Indian National Rupee(s)
DU	Dwelling Unit
LP	Land Premium
ULB	Urban Local Body
UDA	Urban Development Authority
ADA	Area Development Authority
BUA	Built up Area
CA	Carpet Area
SRS	Slum Rehabilitation Scheme
JV	Joint Venture

3. SCHEDULE OF BIDDING PROCESS		
a)	Issue of Advertisement.	dt 23/02/2017
b)	Pre-Bid Meeting.	bidders shall have to post their queries on E-Mail address. slumupgradation@gmail.com on or before dt 15/03/2017 up to 17.00 hrs. Dt. 17.03.2017 At 11.00 Hrs. At Room No. 88, 2 nd Floor Surat Municipal Corporation, Muglisara, Surat.
c)	Last date of submission of Bids online.	dt: 06/04/2017 upto 18.00 hrs.
d)	Last date of receipt of Technical Bids physically.	By RPAD or Speed Post only on or before 07/04/2017 to dt.13/04/2017 upto 17:00 hrs.

4. PROJECT DEVELOPMENT & BIDDING PROCESS

The guideline is being issued to bidders as Volume I of the Request for Proposal (RFP) and must be read in conjunction with the other volumes of the RFP as given below:

Volume – II: Instruction to Bidders.

Volume – III: Specifications.

Volume – IV – General Conditions Of Contract.

5. Introduction

SMC proposes to develop the Integrated Group Housing facility at Slum **T. P. Scheme No. 7 (Anjana), F.P. No. 191 Gandhinagar, Chimni Tekro , Juno Depo & Islampura & F.P. No 45 , Javaharnagar , Nehrunagar , Salimnagar , Gousiya Masjid, Anjana** related to construction of Approximately **2700 dwelling** units. SMC proposes to develop the 'Project' with the Participation of a developer, who would Design, Engineer, Finance, Construct, Operate & Maintain, Transfer the facility including the stipulated Construction Period. The Concession Agreement in two parts (Part A - Development Agreement; Part B- Sale Deed) shall form the legal basis for the Project.

On completion of the construction period the land and building along with all Immovable assets at the project site shall be handed over to SMC by the Developer. However, the developer will have leasehold rights for the part of the slum rehabilitation Plot which is utilized for free sale development.

The Preferred Bidder/ Private Developer selected through a transparent and Competitive Single Stage Bidding process would be given the right to recover its investment through the sale/ leasing / sub-leasing / licensing of the part of the slum rehabilitation plot which is utilized for free sale development within the plot, or usage of TDR (as prescribed in relevant section in RFP) .

The financial bid variable for selection of the preferred bidder, subject to other qualification criteria being met, would be the Minimum per sq. m. price quoted by the bidder/ highest net land premium that the bidder would pay to SMC apart from meeting the fixed parameters of the Bid. Bidders are required to submit separate technical and financial bids. The financial bids of only those bidders that comply with the General Documentation submitted as a part of their technical submission will be opened. The detailed instructions for preparation of technical and financial bids are provided as Volume 2 of this RFP document.

The scheduled construction period of the project shall be **3 years** from the date of Execution of the Development Agreement. (3 YRS FROM THE 10TH DAY OF ISSUE OF WORK ORDER)

The Preferred Bidder to pay SMC liquidated damages for delay beyond the Scheduled Construction Completion Date @ **INR 5,00,000.00** per month of delay or part thereof, as liquidated damage charges until such construction completion is achieved. Municipal Commissioner has reserved the rights to extend the time limit if any circumstances arise. In such cases payment for liquidated damages would be adjusted accordingly.

6. SITE APPRECIATION

1. Site location, area, survey no. and land use as per development plan.

No	Slum Name	Ownership	TP Scheme	FP Number	Area In SqM	Appx. No of Huts	Appx. No of Shops
1.	GANDHINAGAR, CHIMNI TEKRO , JUNO DEPO & ISLAMPURA	SURAT MUNICIPAL CORPORATION	T.P.S No 7 (Anjana)	F.P.No- 191	28,542.00 sq.mt.	1500	56
2.	JAVAHARNAGAR , NEHRUNAGAR , SALIMNAGAR , GOUSIYA MASJID	SURAT MUNICIPAL CORPORATION	T.P.S No 7 (Anjana)	F.P.No- 45	73,331.00 sq.mt.	1200	30
	TOTAL				101873.00 sq.mt.	2700	86

Note:

- No. Of Huts reflect in this RFP may increase or decrease or it may possible to add commercial units. In such cases the project cost and TDR demand would proportionately increase or decrease as per actual site condition.
- Bidder shall provide residential units against residential units and provide shop against commercial unit as per norms prevailing in Gujarat Slum Rehabilitation Policy PPP-2013 of GoG Resolution No. PRS/102013/783/TH, Dt. 18.07.2013
- Site location and Future land use as per development plan of SUDA
- **Site location: Google Image**



3. Future land use as per development plan.

Please do refer applicable **SUDA REVISED DEVELOPMENT PLAN**

Web link: <http://Suda.org.in/SudaGdr/default.aspx> (This site is best viewed in IE7 and above version)

Bidder/Developer shall confirm the future land use from Town planning Department by obtaining zoning certificate.

4. Surroundings:

Sr No	Slum Name	Location	Land Use And Development
1.	Gandhinagar, Chimni Tekro , Juno Depo & Islampura, Anjana, Surat	Tp 7, Fp 191, Gandhinagar, Chimni Tekro , Juno Depo & Islampura, Anjana	Surat Municipal Corporation
2.	Javaharnagar , Nehrunagar , Salimnagar , Gousiya Masjid, Anjana, Surat	Tp 7, Fp 45, Javaharnagar , Nehrunagar , Salimnagar , Gousiya Masjid, Anjana	Surat Municipal Corporation

5. Connectivity and Main Approach road with major nodes:

Sr No	Slum Name	Location	Connectivity
1.	Gandhinagar, Chimni Tekro , Juno Depo & Islampura, Anjana, Surat	Tp 7, Fp 191, Gandhinagar, Chimni Tekro , Juno Depo & Islampura, Anjana	24.38 mt wide road 12.19 mt wide road
2.	Javaharnagar , Nehrunagar , Salimnagar , Gousiya Masjid, Anjana, Surat	Tp 7, Fp 45, Javaharnagar , Nehrunagar , Salimnagar , Gousiya Masjid, Anjana	

6. Terrain

This slum is located on plain terrain.

7. Availability of basic utilities like water supply and electricity.

This slum is having accessibility of key infrastructure services like water, drainage, Storm water network, approach road, street light and electrification up to plot level

7. DEVELOPMENT CONTROLS REGULATION.

Development Regulations: As per Section 2 of General Information. For more details refer General Development Control Regulation (GDCR) available on web link of www.egovsmc.com

Appendices

Appendices-1: Survey Map of Site

Do refer the Auto CAD drawing for Survey Map of Site. Download the drawing. The surveyed CAD drawing is provided for reference only. Bidder/Developer shall confirm the shape of plot, area, dimensions of plot etc. and validate through town Planning department by obtaining part plan.

Appendix-2: Site Plan.



9. GENERAL INFORMATION		
1.	NAME	Development of Integrated Housing Facility over 28,542 sq.mt. +73,331 sq.mt. of land at T.P.S. 7 , FP 191 Gandhinagar, Chimni Tekro , Juno Depo & Islampura & F.P. No 45 , Javaharnagar , Nehrunagar , Salimnagar , Gousiya Masjid, Anjana on PPP basis
2.	LOCATION	Surat, Gujarat
3.	NODAL AGENCY	Surat Municipal Corporation
4	Project Components (For SRS)	<ul style="list-style-type: none"> • Approx No. of (DUs) existing huts : 2700 • Approx total carpet area for SRS. 67500 sq. m.+ 1290 sq.Mt.for shops • Indicative BUA for each DU 29.29. sq. m. • Minimum carpet area for DU 25.00 sq. m. • Indicative no. of storeys: As per prevailing GDCR. • Permissible FSI 3.00 • Approx No. of Shops 40 • Indicative area of the shops 15.00 sq. m. carpet area. • Community hall : As per PPP guidelines / prevailing GDCR • Common plot : 8 % of plot area (however no common plot should be less then 200 SM) • Infrastructures (roads, water supply, sewerage, electricity) • Other facilities (anganwadi/health center/primary school/others) : As per PPP guidelines / prevailing GDCR • Parking : As per PPP guidelines / prevailing GDCR <p>Transit accommodation DU : 2700 (Approx)</p> <p>Special Note:- Total plot area as per record is 73,331.00 Sq.Mt. Contractor/Developer will get total built-up & FSI after deduction of Existing on site construction.</p> <p>Approximate area of existing structure in Sq. Mt is as under.</p> <p>1.Community Hall : 3150.00 sq.mt.</p> <p>2. School :- 5625.00 Sq.Mt.</p> <p>3. Tenement :- 19500.00 Sq. Mt.</p> <p>4. EWS colony:- 7780 .00 Sq.Mt.</p> <p>5. Low Cost Housing:- 17000.00 Sq.Mt.</p> <p>6. Health Centre, Masjid, Temple etc:-4000.00 Sq.Mt.</p>
5.	Land Area	<p>The total land on which slum is situated is termed as "Slum Area" (28542 sq.mt + 73331 sq. m.) As per Record</p> <p>This can be divided into two parcels:</p> <p>Parcel A is the Slum rehabilitation plot where the slum dwellers will be rehabilitated (_____ sq. m.) - to be provided to the selected bidder</p>

		<p>through an open & transparent tendering process).</p> <p>Parcel B – If available after the Slum Rehabilitation Scheme (Offered to the selected bidder as leasehold land (for 99 years) for mixed Development): Total Plot area remaining after development of SRS: _____ sq. m. (to be offered to the selected bidder on long lease for 99 years).</p>
	<p>6. TRANSIT ACCOMMODATION COST</p>	<p>For 2700 no. of families for approximately 36 (thirty six) months INR _____ Crores</p> <p>If there is any government transit accommodation nearby the concerned SRS, the inhabitants of the affected slums will be accommodated in those facilities under the supervision of the concerned public authority as transit accommodation.</p> <p>If there is no such facility nearby, the developer has to arrange for transit accommodation for the affected slum dwellers at his own cost in consultation with the slum dwellers and the implementing agency.</p> <p>The transit accommodations can be rental accommodations arranged by the developer in the vicinity of the SRS.</p> <p>The carpet area for the transit accommodation units should be in between 16-27 sq.m.</p> <p style="color: red;">"At present Approx. 1000 dwelling units of SMC are available for transit accommodation. As and When demand of said dwelling units from successful developer is received, available dwelling units at that time will be allotted to successful developer for transit accommodation with prior approval of competent authority of SMC regarding Rent & Deposit, Terms and Conditions for allotment of said dwelling units to successful developer. Expenditure of rent and deposit towards the same shall be borne by successful developer till completion of project. Moreover, successful developer shall be liable to fulfill condition of allotment and has to hand back the said dwelling units to SMC after carrying out all the necessary repairs, colour work etc. to the satisfaction of SMC. All the Discretionary Powers Whether to give Accomodation or not lies solely with SMC."</p>
7.	ESTIMATED COST OF	INR 216.00 Crores

	REDEVELOPMENT OF NOTIFIED SLUM																					
8.	DEVELOPMENT CONTROLS FOR THE SLUM REHABILITATION PROJECT	<p>Planning Regulations for Rehabilitation Scheme: Any thing content GDCR, the development permission for slum rehabilitation shall be as per following provisions.</p> <ul style="list-style-type: none"> The minimum height of the plinth shall be 45 cm from the top surface of approach road or path way. The carpet area of any dwelling unit shall be minimum 25 Sq. mt. The dwelling unit may include rooms, kitchen, a bath, water closet and exclude common areas such as stairs, passages etc. used for the purpose of residence. Permissible built-up area on any floor including the ground floor, shall be equivalent to the area of building unit left out after leaving margins. For the lay out, the width of the approach road shall be as under. <table border="1" data-bbox="584 880 1422 1120"> <thead> <tr> <th>Sr. No</th> <th>Length of Road</th> <th>Minimum width in mt.</th> </tr> </thead> <tbody> <tr> <td>1</td> <td>Less than or equal to 75 mts.</td> <td>4.5</td> </tr> <tr> <td>2</td> <td>More than 75 mts. and up to and including 150 mts.</td> <td>6.0</td> </tr> <tr> <td>3</td> <td>above 150 mts.</td> <td>As per GDCR</td> </tr> </tbody> </table> <ul style="list-style-type: none"> Minimum area of the common plot shall be at 8% of building unit. however no common plot shall be less than 200 sq.mts. <p>Note: To calculate the common plot requirements the area of the building unit used for the purpose of slum rehabilitation shall be considered.</p> <ul style="list-style-type: none"> Height of the building shall be as under: <table border="1" data-bbox="584 1395 1422 1559"> <thead> <tr> <th>Road width in mts</th> <th>Height of building in mts</th> </tr> </thead> <tbody> <tr> <td>Up to 9.0</td> <td>Maximum 13.5 mts.</td> </tr> <tr> <td>Above 9.0 and up to 18.</td> <td>Maximum 22.5 mts.</td> </tr> <tr> <td>above 18.0</td> <td>Max. Up to 70 mts.</td> </tr> </tbody> </table> <ul style="list-style-type: none"> Lift: lift shall be provided as per the following regulations: <ul style="list-style-type: none"> (a) One lift has to be provided if the nos. of dwelling units exceed 30, and further for one additional lift has to be provided every 30 units or part thereof; (b) Notwithstanding anything contained in (a), one additional lift has to be provided if the building height exceeds 25 mts. (c) The developer shall maintain the lift for 7 years from the date of Building use permission and thereafter he shall, for the purpose of maintenance and upkeep, deposit with the appropriate authority, a 	Sr. No	Length of Road	Minimum width in mt.	1	Less than or equal to 75 mts.	4.5	2	More than 75 mts. and up to and including 150 mts.	6.0	3	above 150 mts.	As per GDCR	Road width in mts	Height of building in mts	Up to 9.0	Maximum 13.5 mts.	Above 9.0 and up to 18.	Maximum 22.5 mts.	above 18.0	Max. Up to 70 mts.
Sr. No	Length of Road	Minimum width in mt.																				
1	Less than or equal to 75 mts.	4.5																				
2	More than 75 mts. and up to and including 150 mts.	6.0																				
3	above 150 mts.	As per GDCR																				
Road width in mts	Height of building in mts																					
Up to 9.0	Maximum 13.5 mts.																					
Above 9.0 and up to 18.	Maximum 22.5 mts.																					
above 18.0	Max. Up to 70 mts.																					

		<p style="text-align: center;">maintenance amount as decided by the competent authority.</p> <ul style="list-style-type: none"> • Margins for the purpose of slum rehabilitation only shall be applicable as under: <ul style="list-style-type: none"> (a) Road Side margin shall be as under <table border="1" style="width: 100%; border-collapse: collapse;"> <thead> <tr> <th style="width: 60%;">Road width In Mts.</th> <th style="width: 40%;">Road Side Margin In mts</th> </tr> </thead> <tbody> <tr> <td>Up to 9</td> <td>3.0</td> </tr> <tr> <td>above 9 & up to 12</td> <td>4.5</td> </tr> <tr> <td>above 12 & up to 18</td> <td>6.0</td> </tr> <tr> <td>above 18 & upto 30</td> <td>7.5</td> </tr> <tr> <td>above 30 & upto 40</td> <td>9.0</td> </tr> <tr> <td>above 40</td> <td>12.0</td> </tr> </tbody> </table> <ul style="list-style-type: none"> (b) Other than Road Side : <table border="1" style="width: 100%; border-collapse: collapse;"> <thead> <tr> <th style="width: 60%;">Building heights in mts</th> <th style="width: 40%;">Margin Other than Road side in mts.</th> </tr> </thead> <tbody> <tr> <td>Up to 10</td> <td>2.5</td> </tr> <tr> <td>above 10 & up to 15</td> <td>3.0</td> </tr> <tr> <td>above 15 & up to 25</td> <td>4.0</td> </tr> <tr> <td>above 25 & upto 45</td> <td>6.0</td> </tr> <tr> <td>above 45 & upto 70</td> <td>8.0</td> </tr> </tbody> </table> (c) 2.0 mts margins shall have to be kept on the side of common plot; provided that, in case of building for less than 25 mtrs height, the competent authority may, after making and inquiry and considering the merits of the case, reduce the margins. however the minimum margins shall not be less than 1.5 mtrs. <ul style="list-style-type: none"> • Parking shall be provided as per GDCR subject to the following conditions:- <ul style="list-style-type: none"> (a) it has to be provided on the ground floor within the portion of ground coverage in the portion left after the non- residential use; (b) Portion of the required parking which could not be provided on the Ground floor has to be provided either in basement or in the common plot. Maximum upto 50% of the common plot can be used for the purpose of parking. Parking provided in the common plot has to be kept open to sky. (c) Parking layout nad other rules for calculations etc shall be as per GDCR. (d) Amenities and scrutiny fees shall be waved. (e) the external wall shall be as per NBC and prevalent GDCR. 	Road width In Mts.	Road Side Margin In mts	Up to 9	3.0	above 9 & up to 12	4.5	above 12 & up to 18	6.0	above 18 & upto 30	7.5	above 30 & upto 40	9.0	above 40	12.0	Building heights in mts	Margin Other than Road side in mts.	Up to 10	2.5	above 10 & up to 15	3.0	above 15 & up to 25	4.0	above 25 & upto 45	6.0	above 45 & upto 70	8.0
Road width In Mts.	Road Side Margin In mts																											
Up to 9	3.0																											
above 9 & up to 12	4.5																											
above 12 & up to 18	6.0																											
above 18 & upto 30	7.5																											
above 30 & upto 40	9.0																											
above 40	12.0																											
Building heights in mts	Margin Other than Road side in mts.																											
Up to 10	2.5																											
above 10 & up to 15	3.0																											
above 15 & up to 25	4.0																											
above 25 & upto 45	6.0																											
above 45 & upto 70	8.0																											

		<p>Planning Regulations for Recipient Plot Maximum Permissible FSI - 3.0 For calculation of maximum permissible FSI - 3.0, the whole area of the land on which slum is situated will be taken in to consideration. According to this calculation, remaining balance FSI if any, after FSI consumed in slum rehabilitation scheme, can be utilized for free sale development by developer on the same plot.</p> <p>TDRs shall be permitted in all zones excepts non-obnoxious industrial, open space, agriculture zone, water body etc. also permitted in projects approved under Hotel & Hospital Policy.</p> <p>Building height allowed on road width of 18 m. or more as per prevailing GDCR.</p> <p>Ground Coverage: The area of the plot after deduction of the land in margins.</p> <table border="1" style="width: 100%; border-collapse: collapse;"> <thead> <tr> <th style="width: 60%;">Road Width</th> <th style="width: 40%;">Road side margin</th> </tr> </thead> <tbody> <tr> <td>Up to 9 m.</td> <td>3.0</td> </tr> <tr> <td>9-12 m.</td> <td>4.5</td> </tr> <tr> <td>12-18 m.</td> <td>6.0</td> </tr> <tr> <td>18-30 m.</td> <td>7.5</td> </tr> <tr> <td>30-40 m.</td> <td>9.0</td> </tr> <tr> <td>More than 40 m.</td> <td>12.0</td> </tr> </tbody> </table> <p>For plots on any road, the margins to be kept as under:</p> <table border="1" style="width: 100%; border-collapse: collapse;"> <thead> <tr> <th style="width: 60%;">Building Height</th> <th style="width: 40%;">Margin other than Road side</th> </tr> </thead> <tbody> <tr> <td>15 m.</td> <td>3.0</td> </tr> <tr> <td>15-25 m.</td> <td>4.0</td> </tr> <tr> <td>25-45 m.</td> <td>6.0</td> </tr> <tr> <td>45-70 m.</td> <td>8.0</td> </tr> </tbody> </table> <ul style="list-style-type: none"> • Important Note for Bidders: In case of any ambiguity in planning norms, GDCR for Affordable housing section of SUDA Development Plan shall be applicable. • Definition for Built up area: Means the areas covered by a building on all floors including the cantilevered positions, if any, including walls and columns, but except the areas specifically excluded under these regulations. • Total Built Up area in SRS (Sq.m) means built up area for residential and commercial units. It is to be noted that built up area for social infrastructure and physical infrastructure should not consider during calculation of total built up area for SRS (Sq.m). 	Road Width	Road side margin	Up to 9 m.	3.0	9-12 m.	4.5	12-18 m.	6.0	18-30 m.	7.5	30-40 m.	9.0	More than 40 m.	12.0	Building Height	Margin other than Road side	15 m.	3.0	15-25 m.	4.0	25-45 m.	6.0	45-70 m.	8.0
Road Width	Road side margin																									
Up to 9 m.	3.0																									
9-12 m.	4.5																									
12-18 m.	6.0																									
18-30 m.	7.5																									
30-40 m.	9.0																									
More than 40 m.	12.0																									
Building Height	Margin other than Road side																									
15 m.	3.0																									
15-25 m.	4.0																									
25-45 m.	6.0																									
45-70 m.	8.0																									

9.	ALTERNATIVE CONSTRUCTION TECHNOLOGY.	<p><i>Apart from conventional technology, any contractor/ developer can use alternative construction material / technology for construction and development of the project.</i></p> <p><i>Traditional building technology is defined as “building construction with load bearing walls or framed structure of RCC beam-columns with BB massonary, fly ash bricks or AC blocks”.</i></p> <p><i>The contractor/developer can have a Joint Venture with the technology provider and form a joint venture, as mentioned in the eligibility criteria. However, bidders engaging such technologies/materials shall have to fulfill the following additional technical criteria:</i></p> <p>Eligibility Criteria:</p> <p><i>The following additional certificates should be submitted in part B:</i></p> <p>A. Certification:</p> <p><i>1. The alternate technology / materials must have the following certification:</i></p> <ul style="list-style-type: none"><i>a) It should be certified by any of the following institutions: Building Materials and Technology Promotion Council/Housing and Urban Development Corporation/ Central Building Research Institute/ Indian Institute of Technology.</i><i>b) For the purpose of testing and quality assurance, either (i) Building materials used in technology should have IS codes or (ii) the institutions specified 1(a) must have also certified construction manual and quality assurances plan including material testing.</i><i>c) The contractor/developer/technology provider should produce all the certificates relevant to the above clauses.</i> <p><i>2. The above clarification should include the following critical quality aspects:</i></p> <ul style="list-style-type: none"><i>a. Structural strength, serviceability, durability and Stability</i><i>b. Structural life of minimum 50 years.</i><i>c. Thermal and energy performance and/ or efficiency</i><i>d. Water penetration</i><i>e. Behavior in fire.</i><i>f. Durability</i><i>g. Behavior against other natural hazards, like earthquake, flood,</i>
----	---	---

		<p>cyclone.</p> <p>h. Construction methodology.</p> <p>i. Quality assurance including material testing.</p> <p>j. The value of the above criteria should be at least as much as provided by the traditional building technology as provided in this tender document or more.</p> <p>B. Other Certifications:</p> <p>The alternative building material / technology must be used at least once in India. Bidder will have to submit completion certificate for at least one building of P+5 or 16.5 meters of height in use in India given by client and building use permission issued by local government authority.</p> <p>C. Details to be submitted by the Contractor/developer in Envelope A.</p> <p>While giving proposal for alternative technology the contractor/developer shall submit the following.</p> <p>k. Product description</p> <p>l. Detailed technical information on how all the materials of the technology (including testing of the materials) meet IS Codes OR certification in this respect given by the above mentioned institution.</p> <p>m. Construction methodology.</p> <p>n. Design assumptions, detailed calculations, references to the necessary design standards and detailed Design drawings.</p> <p>o. Design calculations</p> <p>p. The structural design calculations must clearly demonstrate structural integrity and stability, including connection details</p> <p>q. Design calculations should have proper sketches annotated in English.</p> <p>r. Quality Assurance Plan</p> <p>The screening committee will evaluate the technology on the basis of documents/certificates/design which will be submitted by the developer/contractor/developer as mentioned in the details of submission.</p> <p>C. Bidding Condition:</p> <p>s. The minimum criteria for project will be applicable to the bid with alternative building material /technology which shall have to fulfill the above technical criteria in addition to all the technical eligibility criteria mentioned in volume II in order to be technically qualified.</p>
--	--	--

		<p>t. The minimum specification for interior finishing items can be suitably modified in accordance with alternative building material / technology such that the impact / effect of specified interior finishing is either maintained or enhanced.</p> <p>u. Once shortlisted as technically qualified, its price bids will be opened with all other price bids. There shall not be any additional weight age for alternative building material / technology.</p> <p>v. The decision of screening committee shall be final with respect to the technical eligibility of other alternative building material / technology.</p> <p>E. Scope of Work:</p> <p>w. The scope of work for the project is as mentioned in Volume II; Section 4.</p>															
10.	IMPLEMENTATION FORMAT	<ul style="list-style-type: none"> • Turnkey for the development of all the components of slum rehabilitation. • Public Private Partnership • The payment would be made in TDRs. • if the full plot is not utilized in the slum rehabilitation, the free space of plot remaining after slum rehabilitation will be given to bidder for development with sale rights. 															
11.	RIGHT OF DEVELOPER	<p>The developer will have: Development rights for the Slum Rehabilitation Plot (3 years as construction period) Leasehold rights for the part of the slum rehabilitation plot which is utilized for free sale development.</p>															
12.	CONSTRUCTION PERIOD	<ul style="list-style-type: none"> • Complete all approval, clearance process within 6 months from signing of Development Agreement; • [Note: The Concerned office will facilitate the selected bidder in completion of all approvals and clearances within 6 months from the 10th day of issue of work order.] • Complete the Project and obtain completion certificate from the competent authority within 3 years (which includes above mentioned 6 (six) months from signing of the Development Agreement. <table border="1"> <thead> <tr> <th>Sr. No.</th> <th>Milestones for Development of SRS</th> <th>Time Allowed (from Date of signing of agreement)</th> </tr> </thead> <tbody> <tr> <td>1</td> <td>1/8th (of the whole work)</td> <td>9 months</td> </tr> <tr> <td>2</td> <td>3/8th (of the whole work)</td> <td>18 months</td> </tr> <tr> <td>3</td> <td>3/4th (of the whole work)</td> <td>27 months</td> </tr> <tr> <td>4</td> <td>Full</td> <td>36 months</td> </tr> </tbody> </table>	Sr. No.	Milestones for Development of SRS	Time Allowed (from Date of signing of agreement)	1	1/8th (of the whole work)	9 months	2	3/8th (of the whole work)	18 months	3	3/4th (of the whole work)	27 months	4	Full	36 months
Sr. No.	Milestones for Development of SRS	Time Allowed (from Date of signing of agreement)															
1	1/8th (of the whole work)	9 months															
2	3/8th (of the whole work)	18 months															
3	3/4th (of the whole work)	27 months															
4	Full	36 months															

13.	BID PARAMETER	<p>Either minimum Price quote of SRS quoted by the bidder, or highest net premium, as the case may be. The bid parameter will be decided as follows:</p> <table border="1" data-bbox="584 304 1481 1144"> <thead> <tr> <th>Cases</th> <th>Condition</th> <th>Bid Parameter</th> <th>Calculation</th> </tr> </thead> <tbody> <tr> <td>Case 1</td> <td>If no parcel B is available after SRS</td> <td>Minimum cost of SRS</td> <td>----</td> </tr> <tr> <td>Case 2</td> <td>If parcel B is available after SRS</td> <td></td> <td></td> </tr> <tr> <td>i.</td> <td>When land premium is more than total cost of construction</td> <td>Net premium</td> <td>Net premium=(land premium-total cost of construction)</td> </tr> <tr> <td>ii.</td> <td>When total cost of construction is more than land premium</td> <td>Net cost of SRS</td> <td>Net cost of SRS=(total cost of construction - land premium)</td> </tr> </tbody> </table> <p>Where,</p> <ul style="list-style-type: none"> Land Premium= the land price of parcel B as quoted by the bidder. Cost of construction =Cost of Slum Rehabilitation Scheme Net premium= the premium quoted by the bidder after deducting the cost of SRS from the value of parcel B. Net cost of SRS= the cost quoted by the bidder after deducting value of parcel B from the cost of SRS. <p>Tender validity period is 1 (one) year from the date of Work Order, will be extended more by Mutual consent.</p>	Cases	Condition	Bid Parameter	Calculation	Case 1	If no parcel B is available after SRS	Minimum cost of SRS	----	Case 2	If parcel B is available after SRS			i.	When land premium is more than total cost of construction	Net premium	Net premium=(land premium-total cost of construction)	ii.	When total cost of construction is more than land premium	Net cost of SRS	Net cost of SRS=(total cost of construction - land premium)
Cases	Condition	Bid Parameter	Calculation																			
Case 1	If no parcel B is available after SRS	Minimum cost of SRS	----																			
Case 2	If parcel B is available after SRS																					
i.	When land premium is more than total cost of construction	Net premium	Net premium=(land premium-total cost of construction)																			
ii.	When total cost of construction is more than land premium	Net cost of SRS	Net cost of SRS=(total cost of construction - land premium)																			
14.	PROCESS FOR TDR	<ul style="list-style-type: none"> The minimum price quote for the SRS, submitted by the selected developer shall be converted into Development rights that can be transferred, traded and/or sold in all zones except obnoxious industrial and agricultural zone, open space, water body etc. including in projects approved under Hotel & Hospital Policy within the combined jurisdiction of ULB and the concerned Development Authority. The formulae for conversion of bid price of the selected developer into TDRs shall be as follows: TDR= (Total BUA of SRS)*(per sq. m. bid price/jantri value of recipient land). 																				

		<ul style="list-style-type: none"> • For example, if the total BUA for SRS is 50,000 sq. m., the per sq. m. quoted bid price is INR 30,000 and the jantri rate is INR 10,000/sq. m., then the developer will get a TDR of $(50,000) * (30,000 / 10,000) = 150,000$ sq. m. • TDRs shall be valued at jantri price of the recipient land. • In case of calculation for TDR, The value of TDRs should be measured in terms of the Jantri rate prevailing on the date of signing of the development rights. <p>Building height shall be allowed as per prevailing GDCR . on recipient lands abutting road width of 18 m. or above.</p> <p>The slum TDRs required to achieve the building height specified in addition to free FSI available in that zone, can be transferred to that extent to the concerned recipient land.</p> <p>TDRs shall be transferable/ tradable/ saleable in parts or full only once.</p> <p>TDRs shall be consumed within a period of maximum 7 years from the date of issue.</p> <p>TDRs shall be released in proportion to completed DUs in the multiple of 50s. Last trench of TDR shall be issued on completion of SRS, which can or cannot be in the multiple of 50s.</p> <p>Jantri rate Should be consider as per the last date of online submission of tender. Transfer of TDRs by multipal of 50 DUs, the DUs should be habitable.</p>
15.	LAND PREMIUM	<p>Land premium shall be review with respect to Market price .</p> <p>Quoted land premium for free sale component shall not be less than the existing Jantry price.</p> <p>When there is positive land premium:</p> <p>The Developer to pay to implementing agency:</p> <p>1/3rd of LP to be paid before signing of Development Agreement (1st installment)</p> <p>1/3rd of LP after completion of construction of 33% of the Slum Rehabilitation Scheme (2nd installment)</p> <p>1/3rd of LP after completion of construction of 66% of the Slum</p>

		<p>Rehabilitation Scheme(3rd installment)</p> <p>Along with payment of 2nd installment, the Developer is required to submit a Bank Guarantee equivalent to outstanding amount as on that date.</p> <p>* The interest charged on the outstanding amount will be Base Rate + 5% as interest thereof and will be charged for period.</p> <p>from the submission of BG till payment of the full amount. The Base Rate, as published, will be the rate of the last of day of the preceding month.</p> <p>The sale Deed will be signed on payment of full amount of and Premium or on payment of 2nd Installment plus BG of outstanding Land Premium.</p> <p>The Developer has the option of making pre-payment at very stage.</p> <p>Development on free sale lot can be started only after completion of construction of the DU for the SRS.</p> <p>When there is Negative land premium:</p> <p>If there is another land parcel apart from the SRS plot, and there is negative land premium, the developer/contractor/ developer can develop both the SRS scheme and free sale components parallelly.</p>
<p>16.</p>	<p>INCENTIVES TO THE DEVELOPER</p>	<ul style="list-style-type: none"> • Maximum permissible FSI shall be 3 on the whole plot on which slums are located. • If a part of slum rehabilitation plot remains unutilized after slum rehabilitation, it shall be available to private developer for development for free sale. • Developer shall be provided the following two rights: • Development rights for the Slum Rehabilitation Plot. • Leasehold rights for 99 years for the part of the slum rehabilitation plot which is utilized for free sale Development. • For the purpose of slum rehabilitation only, all municipal & revenue charges shall be waived and relaxation in existing GDCR shall be granted as prescribed in para 8. However, all municipal & revenue charges for free sale development shall be payable and its development shall be as prescribed in

		<p>para 8.</p> <ul style="list-style-type: none"> All the regulations under any prevalent act, rules and GDCR shall apply mutatis mutandis except for the specific provisions mentioned as prescribed in para 8. The prescribed authority shall notify the slum to be Rehabilitated as per Gujarat Slum Act. Any relaxation regarding Zoning will be notified by Town Planning Authority <p>The slum rehabilitation use shall be permissible irrespective of any of provisions of zoning other than restricted zones in the applicable GDCR.</p>
17.	PROJECT DEVELOPMENT FEE & EXPENSES (NONREFUNDABLE AND NON-ADJUSTABLE) – IF APPLICABLE	<p>0.25% of Project Cost* to be payable to implementing agency before signing of Development Agreement;</p> <p>Quoted Project Cost indicated in the financial Bid of the Preferred Bidder will be adopted for this purpose.</p>
18.	BID SUBMISSION	<p>Envelope A: EMD, IT certificate/PAN card, Bank Solvency Certificate etc.</p> <p>Envelope B: Technical & Supporting financial documentation for pre-qualification process.</p> <p>Financial Bid – To be submitted online as per Annexure- I provided in Financial Bid Section.</p> <p>Note :</p> <p>Envelope A and B must have to be submitted in a common Envelope. Envelope A will be opened first and thereafter Envelope B will be opened, if Bidders has submitted Tender Fee, EMD, Bank Solvency Certificate positively in envelope A.</p> <p>Technical Bid along with pre qualifying documents and Envelop – A containing Tender fee and EMD shall be submitted in Hard Copy at following address : “Chief Accountant shri”, Accounts Department, Surat Municipal Corporation, Muglisara, Surat – 395003</p> <p>Bidder should submit Party code issued from Surat Municipal Corporation for refund of EMD.</p>
19.	ENVELOPE A:	<p>The unique transaction reference of RTGS/NEFT against EMD, Tender fee and Bank Guarantee.</p> <p>Bank solvency certificate (20% of Estimate project cost not older than six months).</p> <p>Certificate of Registration for Sales Tax/VAT and Service Tax / any other tax and acknowledgement of up to date filed return duly attested by Registered Chartered Accountant. Necessary document regarding eligible criteria mentioning GI-22.</p>
20.	ENVELOPE B:	<p>Technical & Financial Documentation:</p> <ul style="list-style-type: none"> Proposed layout plan in the scale of 1:500 (minimum) is

		<p>required for the housing pockets.</p> <ul style="list-style-type: none"> • Hard & soft copy of : <ol style="list-style-type: none"> a. proposed plans of (architectural plan such as unit plan, cluster plan, & elevation external service i.e. water supply sewerage, firefighting, storm water drains, rainwater harvesting, sections, elevations of the structures proposed to be constructed etc. (scale 1:100 minimum). b. Plants and electrical design including provision of solar lighting system for building exteriors) drawings and the proposal being offered including detailed write up in completing the built up area for buildings in their hard copies and soft copies in a CD. c. Specifically for this work technical persons proposed to be deployed on the work- their name, experience & qualifications. d. Any other relevant documents as desired by the tenderer. e. Quality Assurance plan. f. Method statement-indicating the methodology proposed to be used for construction of houses, g. Proposed programmed (BAR CHART) schedule for execution of work. h. Centering and shuttering to be used for high rise building be Specified. i. Audited balance sheet of last five financial years. j. Financial information including annual turnover & net worth. k. Certificate of work experience (duly authenticated by client) l. Documents of eligibility criteria (including Form A1-A19) m. All the additional certifications related to alternative building Materials/technology.
21.	Financial Bid:	<ol style="list-style-type: none"> n. To be submitted online (quoting minimum total cost of SRS quoted by the bidder/ highest net land premium, as the case may be.) Performa financial bid is attached (in Annexure-I in Financial Bid) o. Conditional financial bid will be rejected
22.	ELIGIBILITY CRITERIA	<p>Bidder (Single or JV) to demonstrate the capability of:</p> <ul style="list-style-type: none"> • The average annual financial turnover should not be less than amount of the tender divided by No of years for project completion period i.e. time limit of project during last 5 consecutive financial years ending 2015-16. • The average net worth should not be less than 15% of the estimated project cost during last 5 consecutive financial

		<p>years ending 2015-16.</p> <ul style="list-style-type: none">• Experience of having successfully completed similar nature of works as a prime contractor/developer/developer during the last five years ending last day of the month previous to the one in which bids are invited.• Three similar completed works, each costing not less than the amount equal to 40% of estimated cost put to tenders, <p style="text-align: center;">Or</p> <ul style="list-style-type: none">• Two similar completed works, each costing not less than the amount equal to 50% of estimated cost put to tender, <p style="text-align: center;">Or</p> <ul style="list-style-type: none">• One similar completed work of aggregate cost not less than the amount equal to 80% of estimated cost put to tender. <p>If the bidder submits proposal for developing slum rehabilitation project with buildings more than G+4, then the bidder needs to have experience of similar completed work of construction of buildings of a height of minimum 30 mt. /G+10/P+10, otherwise similar experience of G+10 buildings.</p> <ul style="list-style-type: none">• Should have a bank solvency of the amount equal to 20% of the estimated cost of composite work issued by any nationalized or scheduled Bank . The solvency should not be more than six month old.• The value of executed works shall be brought to current costing level by enhancing the actual value of work at simple rate of 10% per annum; Calculated from the date of completion to March-2016. <p>The bidding capacity of the contractor/developer should be equal to or more than the estimated cost of the work put to tender. The bidding capacity shall be worked out by the following formula:</p> <p>Bidding Capacity = [A x N x 2] - B Where,</p> <p>A = Maximum value of construction works executed in any one year during the last five years taking into account the completed as well as works in progress.</p>
--	--	---

		<p>N = Number of years prescribed for completion of work for which bids has been invited.</p> <p>B = Value of existing commitments and ongoing works and LOI issued to be completed during the period of completion of work for which bids have been invited.</p> <p>p. The initial criteria prescribed above in respect of experience of similar class of work completed, bidding capacity and financial turnover etc. will first be scrutinized and the bidder's eligibility for the work to be determined.</p> <p>q. Firm/contractor/developer should submit requisite details/documents with respect to eligibility criteria like, average financial turnover of building works, solvency certificate, details of completed multistoried building works executed, in progress and awarded, details of construction plants and equipments, structure and organization, performance report of work completed or under execution.</p> <p>The firm/contractor/developer has to be registered with any department of state government or any ministry of central govt. /Public authority /Public sector undertaking, Municipal Corporation wsith million plus population for infrastructure development.</p> <ul style="list-style-type: none"> • The firm/contractor/developers should have registration in "AA" Class. • The selected bidders who are not registered in appropriate category or class can also bid provided the bidders shall produce his registration certification before the opening the price bid. <p>Only one type of JV is allowed for the contractor/developer, which is between the technology provider and the contractor/developer himself. In this case, the contractor/developer should submit all the documents regarding the technical & financial eligibility, whereas the technology provider should submit all the certificates related to the construction technology.</p>
23.	DUTIES & RESPONSIBILITIES	<p>Duties & Responsibilities of the Prescribed Authority</p> <ol style="list-style-type: none"> 1. To provide the list of eligible slum dwellers for dwelling units and shops to be allotted free of cost. 2. To facilitate developer/contractor/developer in vacating the slum plot. 3. To notify and earmark the area for the demolition of existing slum of the project put to bid. 4. To approve all the drawings, designs and layouts for slum

		<p>redevelopment project.</p> <ol style="list-style-type: none"> 5. To rehabilitate and redevelop the notified slum of the project put to bid. 6. To grant all the approvals regarding implementation of the slum redevelopment project. 7. To issue TDR certificate as mentioned in 16. 8. To ensure quality of the project implementation by appointing third party inspection agency. 9. To oversee allotment of dwelling units and shops to eligible slum dwellers. 10. To ensure completion of the SRS. 11. To facilitate the slum dwellers in the formation of Service cooperatives or Associations or Societies. 12. To form community-based organizations, wherever required, to ensure the participation of the slum dwellers community. 13. To facilitate developer in vacating the slum plot. <p>Duties & Responsibilities of the Developer:</p> <ol style="list-style-type: none"> 1. Participate in the bid for the project. 2. To design and develop slum rehabilitation scheme as per the planning norms. 3. To provide transit accommodation for the slum dwellers under redevelopment and bear the entire cost of transit accommodation to and fro shifting & final settlement. 4. To provide internal civic services in slum rehabilitation schemes, and to carry out the responsibility of operation & maintenance of the housing schemes for 3 years in case of building units without provision of elevators. 5. Developer has to bear the O&M cost of lift for 7 years in case of building units with provision of elevators. 6. Developer shall have to deposit the corps fund at the rate of Rs 250 per sqmt of built up area and handed over to resident association or housing co-operative society or SMC. 7. To allot the dwelling units and shops to the eligible slum dwellers under the supervision of the prescribed authority.
<p>24.</p>	<p>ALLOTMENT PROCESS</p>	<p>(i). Slum dweller shall be provided with two options for the purpose of rehabilitation:</p> <ol style="list-style-type: none"> 1. Default and preferred option shall be allotment of a Dwelling Unit in the in-situ Slum Rehabilitation Scheme. 2. In case beneficiary chooses not to be so rehabilitated within SRS then the beneficiary shall be entitled to get rehabilitated in any Private Affordable Housing Scheme <p>having minimum specifications within the same city by the selected developer.</p>

		<ul style="list-style-type: none"> The dwelling units constructed under SRS shall be allotted to the eligible slum dwellers by either computerized random draw in the presence of beneficiaries by the developer under the supervision of competent authority. The allotted leasehold DUs shall be joint ownership of the spouse , and shall be so entered in all the relevant records including stamp duty registration and property card. Stamp Duty Registration of the dwelling unit shall be made on Rs.100/- Stamp paper. The beneficiary shall be granted leasehold property rights for first 15 years and freehold property rights thereafter only for DU. Ownership of the land shall remain with the SMC. Developer shall have to comply with the time schedule, failing to do so, he shall be penalized for delay or late completion of SRS for reasons attributed to him, as prescribed in para 33 & 34. Once the SRS is certified to have been completed by the competent authority, the developer shall hand over the maintenance of services to the association of slum dwellers Eligible slum dwellers occupying shops in slum shall be entitled for allocation of shop in SRS of minimum 15 sq. m. carpet area.
25.	BID EVALUATION	Envelope A: General Documentation: Pass/Fail. Envelope B: As per para 20 (also envelope B)
26.	BID VALIDITY	180 days from the last date of receipt of bid
27.	EARNEST MONEY	1% of estimated project cost i:e INR 2,16,00,000/- should be paid in the form of Demand Draft of nationalized or scheduled Banks , payable at Surat only. OR 50% amount shall be in the form of Demand Draft and 50 % amount Shall be in the form of of natioanalised or scheduled Banks , payable at Surat only; along with Envelope - A
28.	VALIDITY OF EARNEST MONEY DEPOSIT	210 days beyond the original validity period of the Bid.
29.	SECURITY DEPOSIT	5 % of the project cost to be submitted within 15 days after awarding LOI in the form of Bank guarantee of nationalized or scheduled Banks , payable at Surat only.
30A.	RELEASE OF SECURITY DEPOSIT	As per clause 1. (security deposit)
30 B.	PERFORMANCE	As per clause 1. (performance Guarantee/Bond) and clause 1A.

	GUARANTEE	(Recovery of performance Guarantee/Bond)
31.	VALIDITY OF PERFORMANCE SECURITY	as above (30 B)
32.	DEFECTS LIABILITY PERIOD	7 years from the date of completion of SRS
33.	DEVELOPER'S DEFAULT – BEFORE SIGNING OF AGREEMENT	Forfeit earnest money. <ul style="list-style-type: none"> • In case of land premium, return of Land Premium without any interest thereon • Cancellation of Development Agreement • No compensation to be paid by the SMC. • Black listing of developer
34.	DEVELOPER'S DEFAULT – AFTER SIGNING OF AGREEMENT	The Earnest money as well as Security deposit deposited by the contractor/developer shall be forfeited absolutely. <ul style="list-style-type: none"> • In case of land premium, forfeit the Land Premium paid as on that date. • No compensation to be paid by the SMC. • Cancellation of Development Agreement. • Reduction in TDR • Black listing of developer • Financial penalty
35.	COMMUNITY PARTICIPATION	Slum community participation shall be ensured at every stage of implementation of SRS for effective planning and implementation by the selected developer. NGOs/CBOs may be engaged by the developer for participation of slum community and their smooth rehabilitation. Community participation shall be sought in following manner: <ol style="list-style-type: none"> 3. Co-operation in Mapping, Survey, registration and creation of database leading to preparation of Slum rehabilitation scheme plan. 4. Micro-planning during preparation of Slum rehabilitation scheme. 5. Implementation and Operation and Maintenance of the SRS: For this purpose community-based organization at the slum level may also be formed.
36.	ASSUMPTIONS	1 acre=4046.872 Sq.m 1 Sq.m=10.763 Sq.ft

37.	Contact Details:	Vikram Dalal Sarjan Architects & Project Consultants, 51,River palace, Wing-A, Opp.Old Civil Court, Nanpura, surat, Contact:-9879604444. E Mail:- sarjanarch.pc@gmail.com Executive Engineer, Mr. M. P. Jaimalani, (9724327282) Deputy Engineer. Mr. Y.C. Patel (9724345440) Junior Engineer Mr. P.P. Thakkar (9825808747) Mr. M.I. Patel (99797579572)
------------	-------------------------	--

Executive Engineer
Slum Upgradation Department
Surat Municipal Corporation

SIGNATURE OF THE CONTRACTOR / DEVELOPERS

DATE :

NAME AND ADDRESS :-

Where the contractor is required to submit bank guarantee against payment towards any deposit e.g. EMD, SD, etc., such bank guarantees shall be produced only from any one of the Nationalized/Schedule banks payable at Surat. (As per Audit/contingency/109/2016-17 dtd. 18/03/2017.

SURAT MUNICIPAL CORPORATION

SLUM UPGRADATION DEPARTMENT



NAME OF WORK: Development of Integrated Group Housing Facility at T. P. Scheme No. 7 (Anjana), F.P. No. 191 Gandhinagar, Chimni Tekro , Juno Depo & Islampura & F.P. No 45 , Javaharnagar , Nehrunagar , Salimnagar , Gousiya Masjid, Anjana at Surat on Public Private Partnership (PPP) basis under Mukhya Mantri Gruh Yojana(Work No.1)

E- Tender

TENDER NOTICE NO : DC/SUC/12/2016-17

VOLUME-II : INSTRUCTIONS TO BIDDERS

SERIAL NO. OF THE WORK	: 1
DOWNLOADING OF TENDER DOCUMENTS STARTS FROM	: Dt. 04/03/2017
DATE OF PRE-BID CONFERENCE	: through e-mail before Dt. 15/03/2017
LAST DATE OF DOWNLOAD OF TENDER DOCUMENTS FROM website smc.nprocure.com	: Dt. 06/04/2017 upto 17.00 hrs
LAST DATE OF SUBMISSION OF ONLINE TENDER	: Dt. 06/04/2017 upto 18.00 hrs
LAST DATE OF SUBMISSION OF TENDER FEES, EMD AND OTHER DOCUMENTS IN HARD COPY	: During Dt. 07/04/2017 to 13/04/2017 upto upto 17.00 hrs
ESTIMATED AMOUNT	: Rs. 216,00,00,000.00

**TENDER TO BE SUBMITTED TO:
THE CHIEF ACCOUNTANT,
SURAT MUNICIPAL CORPORATION, MUGLISARA
SURAT – 395 003.
BY R.P.A.D. / THROUGH POSTAL AUTHORITY / SPEED POST ONLY**

NAME OF WORK :- Development of Integrated Group Housing Facility at T. P. Scheme No. 7 (Anjana), F.P. No. 191 Gandhinagar, Chimni Tekro , Juno Depo & Islampura & F.P. No 45 , Javaharnagar , Nehrunagar , Salimnagar , Gousiya Masjid, Anjana at Surat on Public Private Partnership (PPP) basis under Mukhya Mantri Gruh Yojana(Work No.1)

e-TENDER (Online) NOTICE NO. : DC/SUC/12/2016-17

WORK NO. 1

Last date of submission of online Tender :

On or before Dt. 06/04/2017 up to 18.00 hrs

Last date of submission of All necessary documents mentioned in Technical bid (Volume II) (if any), Tender Fees, EMD and Other Documents in Hard Copy :

From Dt. 07/04/2017 to Dt.13/04/2017 up to 17:00 hrs at the office of Chief Accountant, Surat Municipal Corporation, Muglisarai, Surat- 395 003.

Earnest Money : **Rs. 216,00,000.00** should be paid in the form of Demand Draft of Nationalized/ Scheduled Banks, payable at Surat only.

OR

50% amount shall be in the form of Demand Draft and 50 % amount Shall be in the form of Bank guarantee of Nationalized/ Scheduled Banks, payable at Surat only.

Tender Fee : **Rs. 18,000.00** should be paid shall be in the form of Demand Draft of Nationalized/ Scheduled Banks, payable at Surat only.

Pre-Bid : Bidders shall have to post their queries on e-mail address slumupgradation@gmail.com before Dt. 15/03/2017 upto 17:00 hrs.

EXECUTIVE ENGINEER
SLUM UPGRADATION DEPARTMENT
SURAT MUNICIPAL CORPORATION

SIGNATURE OF THE CONTRACTOR.

DATE :

NAME AND ADDRESS :-

TECHNICAL BID

NAME OF WORK : Development of Integrated Group Housing Facility at T. P. Scheme No. 7 (Anjana), F.P. No. 191 Gandhinagar, Chimni Tekro , Juno Depo & Islampura & F.P. No 45 , Javaharnagar , Nehrunagar , Salimnagar , Gousiya Masjid, Anjana at Surat on Public Private Partnership (PPP) basis under Mukhya Mantri Gruh Yojana

Estimated Amount :- Rs. 216,00,00,000.00

E.M.D. :- Rs. 2,16,00,000.00

Tender Fee :- Rs. 18000.00

Receipt No. :- _____

Date :- _____

Issued to

CONTRACTOR _____

**Issuing Office : Executive Engineer, Slum Upgradation Department,
Old Rander Zone Office, Tadwadi, Rander Road,
Surat Municipal Corporation,
Surat.**

Signature & Date of the Issuing Officer :-

**Executive Engineer
Slum Upgradation Department
Surat Municipal Corporation.**

**SIGNATURE OF THE CONTRACTOR/DEVELOPER.
DATE :**

NAME AND ADDRESS :-

CONTENTS

SR.NO	PARTICULARS	PAGE NO
	Volume 2: Instruction to Bidders	
1	GENERAL INFORMATION & INSTRUCTIONS	46
	<i>Form of Bid / Address for Submission / Deadline</i>	46
	<i>Pre - Bid Meeting</i>	47
	<i>Bidder's Responsibility for Data</i>	47
	<i>General Information to Bidders</i>	49
	<i>Instructions of the Joint Venture</i>	50
	<i>Validity of Terms of the Bid</i>	51
	<i>Miscellaneous Instructions to the Bidders</i>	52
	<i>Powers of Attorney</i>	53
	<i>Earnest money deposit to be paid by the Bidders</i>	53
	<i>Modifications or Withdrawals of the Bids</i>	54
	<i>Responsiveness of Bids</i>	54
	<i>Opening of Bids</i>	54
2	INSTRUCTIONS FOR TECHNICAL BID SUBMISSION	58
	<i>Overall submission for General Documentation</i>	58
3	INSTRUCTIONS FOR FINANCIAL BID SUBMISSION	61
4	SCOPE OF WORK	63
	<i>Annexure A1- Covering letter for Envelope A</i>	69
	<i>Annexure A2- Integrity Pact</i>	71
	<i>Annexure A3- Letter of Transmittal</i>	75
	<i>Annexure A4- Description of the Bidding Company, Project Experience & Financial Strength</i>	76

	Annexure A5- Letter of Acceptance/ Memorandum of Understanding(MoU) (applicable in case of JV)	77
	Annexure A6- Bank Solvency Certificate	79
	Annexure A7- Power of attorney for appointing Lead Member in case of JV	80
	Annexure A8- Power of attorney for appointing signatory for the proposal	82
	Annexure A9- Information of Litigation	84
	Annexure A10- Performa of Bank Guarantee for Bid Security	85
	Annexure A11- Project Cost	87
	Annexure A12- Means of Financing	89
	Annexure A13- Net Worth & Net Cash Profits	90
	Annexure A14- Details of all Works Similar Class Completed	91
	Annexure A15- Details of all Works Similar Class Completed with any other Construction Technology apart from Conventional Technology	92
	Annexure A16- Project under Execution/Awarded	93
	Annexure A17- Details of Executive & Personnel	94
	Annexure A18- Details of Plants & Equipments	95
	Annexure A19- Financial Qualification	97
	Annexure 20: Project Summary	98
	Annexure 21: AFFIDAVIT	100
	Annexure 22: Instruction	101
	Annexure 23	102

Volume - II
INSTRUCTIONS TO BIDDERS

1.GENERAL INFORMATION & INSTRUCTIONS

FORM OF BID / ADDRESS FOR SUBMISSION / DEADLINE.

- 1.1. The bidders are required to submit Technical Bids in separate sealed envelopes, Clearly marked as follows:

Envelope B

“Technical Bid for Development of Integrated Group Housing Facility over 28,542 sq.mt. +73,331 sq.mt. of land at T.P.S. 7 , FP 191 Gandhinagar, Chimni Tekro , Juno Depo & Islampura & F.P. No 45 , Javaharnagar , Nehrunagar , Salimnagar , Gousiya Masjid, Anjana Surat ,Gujarat”

Submitted By: [Name of Bidder]

- 1.2 For the Technical Bid, the bidders are required to submit within the envelopes a Total of two (2) copies, i.e. one (1) original and one (1) copy duplicate. An authorized Signatory of the bidder (Lead Member in case of JV) is required to initial each Page of the original copy of the Technical Bid.
- 1.3 For the Financial Bid, the bidders are required to submit it online (quoting Minimum total cost of SRS quoted by the bidder/ highest net land premium, as the case may be.) Performa financial bid is attached (in Annexure-I in Financial Bid)
- 1.4 The separate envelopes containing the “Envelop A” and “Envelop B” shall be placed in a sealed outer envelope or box, clearly marked as follows, *‘Bid for Development of Integrated Group Housing Facility over 28,542 sq.mt. +73,331 sq.mt. of land at T.P.S. 7 , FP 191 Gandhinagar, Chimni Tekro , Juno Depo & Islampura & F.P. No 45 , Javaharnagar , Nehrunagar , Salimnagar , Gousiya Masjid, Anjana on PPP basis Surat ,Gujarat’*
- 1.5 The bids shall be submitted to the following address:

**The Chief Accountant,
SURAT MUNICIPAL CORPORATION,
MUGLISARA,
SURAT- 395003**

BY RPAD / THROUGH POSTAL AUTHORITY / SPEED POST ONLY.

- 1.6 The bids shall be received at the above address before time and date given as per advertisement for RFP. Bidders can submit their bids by RPAD or Speed post so as to reach the designated address within the stipulated deadline for submission. SMC or any of its agencies/advisors shall not be responsible for any delay in receipt of bids. Any bid received after the due date/time for submission of bids shall not be opened / evaluated and shall be deemed to be rejected for all purposes.

➤ **PRE-BID MEETING**

For pre-bid meeting Bidder shall have to post their (held as per date and time given in advertisement for RFP to clarify any) queries on E-Mail address slumupgradation@gmail.com on or before date 15/03/2017 up to 17.00 hours at the address above. The venue of Pre-Bid meeting would be intimated to bidder on line on N-Procure.

The minutes of the pre- bid conference incorporating the clarifications will be circulated to all the bidders and shall form part of this RFP document.

➤ **BIDDER'S RESPONSIBILITY FOR DATA**

While preparing the Technical and Financial Bids, the bidder shall consider the information based on studies undertaken on behalf of SMC by any of its agencies/consultants/advisors. However, Bidder shall be wholly responsible for all the details of its Bid, the physical and site conditions, the execution methodology, etc. In essence, after the bid is submitted, the bidder shall be the 'owner' of all the data, which forms the basis of Technical Bid and Financial Bid.

- The bidder shall be responsible for all the data provided in Technical and Financial Bids. The Bids should be prepared in reasonable detail to enable SMC or its nominated agencies/advisors to evaluate the Bids and select the successful bidder.
- The bidder is advised to carry out necessary technical surveys, field Investigations, market & demand assessment, etc. at its own cost and risk, before submitting the Technical and Financial Bid.
- SMC or any of its agencies/consultants/advisors reserves the right to vet and verify any or all information submitted by the Bidder. SMC's decision regarding any Bidder's eligibility or otherwise shall be final and binding and SMC and/or any of agencies/consultants/ advisors would be under no obligation and/ or responsibility to inform any Bidder of the grounds of such decision / rejection.
- Bidders shall provide evidence of their continued eligibility, in accordance with the technical Bid in a manner that is satisfactory to SMC and as SMC may reasonably request till signing of Development Agreement and sale deed. A Bidder may be disqualified, if it is determined by SMC at any stage of the bidding process, that the Bidder will be unable to fulfill the requirements of the Project or fails to continue to satisfy the qualification criteria.

- Supplementary information or documentation regarding qualifications if any sought for from the Bidders at any time must be provided within the time frame stipulated in such request(s).
- Bidders may be required to periodically update, at any time as may be notified by SMC, the information submitted in their Bids as regards the following:
 - (a) Evidence of access to project funding and its sources; provided in this RFP in totality.
The details of the Project, given in this RFP and veracity of the data or designs and drawings given in this RFP;
 - (b) Annual Reports including Balance Sheet and Profit & Loss Account of all members of the JV;
 - (c) Proof of experience in designing, constructing, implementing, Operating and maintaining and marketing projects similar to the Proposed Project.
- Bidders may, prior to submitting their Bid for the Project, visit and examine the Site of the Project and its surroundings at their own expense and obtain and ascertain for themselves, all technical data, demand and other information necessary for preparing their Bids.
- For the above purpose, the bidders may approach SMC for assistance during any site visit.
The bidders shall be responsible for all arrangements and shall release and indemnify SMC and/or any of its agencies/consultants/advisors from and against all liability in respect thereof and shall be solely responsible for any personal injury, loss of or damage to property or any other loss, damage, costs or expenses, however caused, which, but for the exercise of such permission, would not have arisen.
- The Bidders shall be deemed to have full knowledge of the site, whether physically inspected or not and any objection / allegation of inadequate / nor availability / suppression of information either before or after submission of bid shall not be entertained irrespective of its consequences.

➤ **GENERAL INFORMATION TO BIDDERS**

- The bidder shall bear all costs associated with the preparation and submission of its Technical and Financial Bids, including data collection, analysis, design, etc. Neither the SMC nor any of its agencies/consultants/advisors will be responsible or liable for all such costs, regardless of the conduct or outcome of the bidding process.
- Information relating to the examination, clarification, evaluation and comparison of proposals and recommendations for the award of a contract shall not be disclosed to Bidders or any other persons not officially concerned with such process until the award to the successful Bidder has been announced. Any effort by a Bidder to influence SMC or any of its agencies/consultants/advisors processing of bids for award shall result in the rejection of the bid.
- To assist in the examination, evaluation, and comparison of proposals, SMC or any of its agencies/consultants/advisors may, at its discretion, ask any Bidder for clarification. SMC or any of its agencies/consultants/advisors may utilize the services of any consultant or other advisor to assist in the examination, evaluation and comparison of proposals. However, clarifications if any required from bidder, shall be in written form and will be communicated to bidder by SMC or any of its agencies/consultants/advisors.
- In case of difference between original and photocopies, information/ data/ bid provided in the original would prevail.
- SMC will check bids determined to be substantially responsive for any arithmetic errors. Wherever there is discrepancy between the amounts / percentage in figures and in words, the amount / percentage expressed in words will govern. Any such corrections made by SMC shall be considered as binding upon the bidder. If the bidder does not accept the corrections in proposal, SMC may reject the Bid and Bid Security will be forfeited.
- **Eligible Bidders** The Bidder may be a single entity ('Bidding Company') or a group of entities (Joint Venture), coming together to implement the Project. The expression 'entities', for the purpose of this clause, shall mean and refer to corporate entities incorporated under the Companies Act, 1956. The term Bidder used hereinafter

would therefore apply to both a single entity and a JV. The Bidder should submit a Power of Attorney as per the format enclosed at Annexure A8, authorizing the signatory of the Bid to commit the Bidder. In case the Bidder is a JV, it must comply with the additional requirements for bidding as a JV as specified in the Clause for joint venture.

- At any point in time in the Bidding Process, if required by SMC, it is the Bidders' responsibility to provide such evidence of their eligibility as per the terms of the RFP, to the satisfaction of SMC. Bidders may be required to periodically update (at times to be notified by SMC) the information submitted in their Capability Statement as regards the following:
 - Evidence of availability of financial resources & technical Capability;
 - Commitments of other works awarded since submitting the Bid;
 - Any other information that might be requested
 - Any information known to the Bidder that may affect its ability to perform the contractual obligation.

A Bidder may be disqualified if it is determined by SMC, at any stage of the bidding process that the Bidder fails to continue to satisfy the Eligibility Criteria /Technical and Financial Criteria. RFP is open to participation by any persons or bidder in any manner from any country subject to Applicable Laws and regulations of Government of India.

The Selected Bidder in the form of a single entity ('Bidding Company') or a group of entities ('JV') shall fulfill some criteria so as to enter into a Development Agreement. Such criterion should be specified in the LoI (Letter of Intent).

INSTRUCTIONS FOR JOINT VENTURE

- **Only one type of JV is allowed for the contractor/developer, which is between the technology provider and the contractor/developer/developer himself.** In this case, the contractor/developer/developer should submit all the documents regarding the technical & financial eligibility, whereas the technology provider should submit all the certificates related to the construction technology.
- In case the bidder is a JV, the members of the JV shall furnish a Power of Attorney designating one of the members, as per the JV Agreement, as their Lead Member.

The Lead Member would be fully responsible for satisfactory performance under the terms of the Agreement to be signed with SMC.

- Wherever required, the Bid should contain the information required for each member of the JV.
- The bid shall be signed by the duly authorized signatory of the Lead Member and shall be legally binding on all the members of the JV.
- The Bid should include a description of the roles and responsibilities of Individual members.
- The Lead Member must be able to demonstrate its ability of financial capacity to invest in the project.
- Any change in the composition of a bidding JV after the final date of submission of bids, as given in this document, would result in disqualification of the Bidder.
- No member can propose to be a member of more than one Bidding JV for submission of bids for the Project.
- A copy of the JV Agreement registered should be submitted with the Bid. The JV Agreement entered into among the members of the JV should be specific to this Project and should contain the above requirements failing which the Application should be governed by the laws, rules and regulations of India and should be subject to jurisdiction of Indian Courts only.

Amendment of RFP

- SMC may modify the RFP by issuing an Addendum before Due Date.
- Any Addendum and Corrigendum thereto, thus issued shall be part of the RFP and shall be published online on SMC's website: <https://smc.nprocure.com>. SMC will assume no responsibility for receipt of the Addendum and Corrigendum.
- To give prospective Bidders reasonable time in which to take any Addendum and/or Corrigendum into account in preparing their bids, SMC may, at its sole discretion, extend the Due Date.

VALIDITY OF TERMS OF THE BID

- Each bid shall indicate that it is a firm and irrevocable offer, and shall remain valid and open for a period of not less than **180 days** from the last date for submission of the bid. Non-adherence to this requirement may be a ground for declaring a bid as n-

responsive. However, SMC may solicit any bidder's consent for extension of the period of validity if the bidder agrees to reasonably consider such a request. The request and response shall be in writing. A bidder accepting such an extension shall not be permitted to modify his bid in any other respect.

MISCELLANEOUS INSTRUCTIONS TO BIDDERS

- All Bidders should note the following:
- Bids that are incomplete in any respect or those that are not consistent with the requirements as specified in this *Request for Proposal* may be considered nonresponsive and may be liable for rejection;
 - Strict adherence to formats, wherever specified, is required. Non-adherence to formats shall be a ground for declaring a Bid non-responsive;
 - All communication and information should be provided in writing and in English language only;
 - All financial data shall be in Indian Rupees only;
 - The metric system shall be followed for units;
 - All communication and information provided should be legible, and wherever the information is given in figures, the same should also be mentioned in words. In case of conflict between amounts stated in figures and words, the amount stated in words will be taken as correct;

No change in, or supplementary information to a Bid shall be accepted once submitted. However, SMC or any of its agencies/consultants/advisors reserves the right to seek additional information from the Bidders, if found necessary, during the course of evaluation of the Bid. Non-submission, incomplete submission or delayed submission of such additional information or clarifications sought by SMC or any of its agencies/consultants/advisors, can be a ground for rejecting the Bid;

- If any claim made or information provided by the Bidder in the Bid or any information provided by the Bidder in response to any subsequent query by SMC or any of its agencies/consultants/advisors, is found to be incorrect or is a material misrepresentation of facts, then the Bid will be liable for rejection. Mere clerical errors or bonafide mistakes may be treated as an exception at the sole discretion of SMC or any of its

agencies/consultants/advisors, and if SMC or any of its agencies/ consultants/ advisors, is adequately satisfied;

- The Bidder shall provide, in the Technical Bid, the names and relevant experience of subcontractor/developers, consultants, agents, and agencies to be retained for executing the construction and operation activities on behalf of bidding JV;

POWERS OF ATTORNEY

For JV, other member of the JV (apart from the lead member) shall submit a Power of Attorney, registered and on a stamp paper of an appropriate value, appointing the lead member to act on its behalf in such capacity as its representative for the implementation of the Project by the Bidding JV. The format for the same is provided as Annexure A7 to this document.

For the lead member of a bidding JV and also for companies bidding singly, a Power of Attorney, registered and on a stamp paper of an appropriate value, issued and signed by an authorized signatory of the lead member in favour of a specified person to act as the official representative of the bidding JV/bidder for the purpose of signing documents, making corrections/modifications and interacting with SMC or any of its agencies/consultants/advisors, and acting as the contact person shall be submitted. The format for the same is provided as Annexure A8 to this document.

EARNEST MONEY TO BE PAID BY THE BIDDERS

Each bidder shall furnish, along with the Technical Bid in Envelope A, an Earnest Money Deposit amounting to 1% of estimated project cost for the Project as per Volume I, G I Section 29. The Earnest Money shall be in the form of an unconditional and irrevocable Earnest Money from listed banks mentioned tender in India in favour of “**Surat Municipal Corporation**”. The Earnest Money shall remain valid for a period of **210 days** beyond the original validity period for the bid.

Any bid not accompanied by an acceptable Earnest Money, in the manner stated above, shall be the ground amongst others for rejection of bid as non-responsive.

The Earnest Money of unsuccessful bidders will be returned as promptly as possible, but not later than 1 year after the expiration of the bid validity period, or selection of the preferred bidder, whichever is later.

- The Earnest Money will stand forfeited if:
 - (a) Bids are withdrawn within the validity period;
 - (b) Successful Bidder fails to sign the Development Agreement;
 - (c) Successful Bidder fails to provide security deposit within the stipulated time period;

(d) Bidder fails to provide project development fees (to SMC) in a manner as specified in the Letter of Intent (LoI)/ Letter of Award (LoA).

The preferred bidder will be required to make available security deposit which can be converted as performance securities after completion of project.

MODIFICATIONS OR WITHDRAWALS OF BIDS

Any Bidder may modify or withdraw its Bid after submission prior to the deadline for submission of bids, provided that SMC receives in time the written notice of the modification or withdrawal. The responsibility of submitting the modified bid within the deadline for submission of bids will rest solely with the bidder.

No bidder shall be allowed to modify its bid after the deadline for submissions. Bidder shall be allowed to modify the bid after the last date, only if the same is requested by SMC, to accommodate clarifications on the Bid submitted, subject to the Bid substantially conforming to the requirements of this solicitation.

In the event of withdrawal of a bid by any bidder within the validity period, the bid security submitted by the bidder shall stand forfeited.

RESPONSIVENESS OF BIDS

➤ A Bid shall be deemed “non-responsive” if it does not satisfy any of the following conditions:

- It is not received by the due date and time;
- It does not include sufficient information/qualification for it to be evaluated and/or is not in the formats specified in this RFP;
- It is not signed and/or sealed in the manner or accompanied by powers of attorney as specified in this RFP;
- Non-submission of Earnest Money of the specified amount as Bid Security;
- **Non submission of required document (s) as specified in this RFP.**

OPENING OF BIDS

The Financial Bids would be opened after completion of the verification of the compliance of the general documentation submitted as Technical Bid. The Financial Bids of only those bidders whose Technical Bids have been found to be responsive would be opened. SMC or any of its

agencies/consultants/advisors shall duly inform the technically qualified bidders of the time and place for the opening of Financial Bids. The Financial Bids of bidders failing the evaluation of

Technical Bids will be returned unopened to the Bidders after signing of Development Agreement with the Preferred Bidder.

Criteria for Evaluation

Evaluation Parameters

- The Bidder's competence and capability is proposed to be established by the following parameters:

(a) Technical Experience

(b) Financial capability factor, in terms of:

- i. Turn over
- ii. Net Worth
- iii. Bid capacity

On each of these parameters, the Bidder would be required to meet the evaluation criteria as detailed in this Section. Bidders meeting all the criteria only will be qualified for further evaluation of the Proposal.

Bids without Bid Security fee/Bid fee will be out rightly disqualified.

MINIMUM QUALIFYING CRITERIA FOR THE BIDDER

- The Bidders should satisfy the following minimum parameters.

TECHNICAL PARAMETERS

- Bidder (Single or JV as per Tender) to demonstrate the capability of:
 - Experience of having successfully completed similar nature of works as a prime contractor/developer during the last five years ending last day of the month previous to the one in which bids are invited.
 - Three similar completed works, each costing not less than the amount equal to 40% of estimated cost put to tenders,

Or

- Two similar completed works, each costing not less than the amount equal to 50% of estimated cost put to tender,

Or

- One similar completed work of aggregate cost not less than the amount equal to 80% of estimated cost put to tender.

If the bidder submits proposal for developing slum rehabilitation project with buildings more than G+4, then the bidder needs to have experience of similar Completed work of construction of buildings **of a height of minimum 30 mt /G+10/P+10.**

FINANCIAL PARAMETERS.

- The average annual financial turnover should not be less than amount of the tender divided by No of years for project completion period i.e. time limit of project during last 5 consecutive financial year ending **2015-16.**
- The average net worth should not be less than 15% of the estimated project cost during last 5 consecutive financial years ending **2015-16.**
- Should have a bank solvency of the amount equal to 20% of the estimated cost of composite work issued by the Bank as per attached list. The solvency should not be more than six month old.
- The value of executed works shall be brought to current costing level by enhancing the actual value of work at simple rate of 10% per annum; Calculated from the date of completion to March-2016.
- The bidding capacity of the contractor/developer should be equal to or more than the estimated cost of the work put to tender. The bidding capacity shall be worked out by the following formula:

Bidding Capacity = $[AxNx2]-B$ Where,

- A = Maximum value of construction works executed in any one year during the last five years taking into account the completed as well as works in progress.
- N = Number of years prescribed for completion of work for which bids has been invited.
- B = Value of existing commitments and on-going works and LOI issued to be completed during the period of completion of work for which bids have been invited.
- The initial criteria prescribed above in respect of experience of similar class of work completed, bidding capacity and financial turnover etc. will first be Scrutinized and the bidder's eligibility for the work to be determined.
- Firm/contractor/developer should submit requisite details/documents with respect to eligibility criteria like, average financial turnover of building works, solvency certificate, details of completed multi-storeyed building works executed or

awarded, details of construction plants and equipments, structure and organization, performance report of work completed or under execution.

- The firm/contractor/developer has to be registered with any department of state government or any ministry of central govt. /Public authority /Public sector undertaking, Municipal Corporation with million plus population for infrastructure development.
- The contractor/developers who are not registered in appropriate category or class can also bid provided the bidders shall produce his registration certificate before the opening of the price bid.
- To qualify for the opening of Financial Bid, a bidder must comply with all the Annexures as listed in 2.1 follow the respective formats.
- SMC intends to complete the entire process of bid evaluation and award within a period of **180 days** from receipt of bids. In order to enable SMC to meet the target, Bidders are expected to respond expeditiously to clarifications, if any, requested during the evaluation process. SMC shall adhere to the above schedule to the extent possible. SMC, however, reserves the right to modify the same. Intimation to this effect SMC shall be given to all Bidders including request for extending the bid validity if required.
- In addition to the other requirements covered above, the Bidder should provide information about any litigation or arbitration resulting from contracts

Undertaken by the Bidder (including individual members of bidding JV) in the last five years. Suppression of any information or material in this regard would be construed as a fundamental breach and SMC reserves the right to take appropriate action including cancellation of the Bid, forfeiting of Bid Security, etc. as may be deemed fit and proper by SMC at any time without requiring to give any notice to the Bidder in this regard.

- **The Municipal Commissioner reserves the right to reject or accept any or all tenders without assigning any reason whatsoever.**
- Contractor/developer shall have to make his own arrangements for water and electricity for the purpose of construction work at site at his own expenses.

2. INSTRUCTIONS FOR TECHNICAL BID SUBMISSION

OVERALL SUBMISSION FOR GENERAL DOCUMENTATION

2.1 General Documentation (Submission must for proposal to be considered technically responsive)

In this section, the Bidders will provide the general documentation and information required for the proposals to be considered responsive. Some of these are applicable only for specific bidding firms and need not be provided by others (Annexures A3, A4 and A5). The formats for these documents are provided as Annexures to this volume (Annexures A1-A10), covering the following:

Section 1	General parameters and evaluation
Annexure A1	Covering letter for Envelope A
Annexure A2	Integrity Pact
Annexure A3	Letter of Transmittal
Annexure A4	Description of the Bidding Company, Project Experience & Financial Strength
Annexure A5	Letter of Acceptance/ Memorandum of Understanding (MoU) (applicable in case of JV)
Annexure A6	Bank Solvency Certificate
Annexure A7	Power of attorney for appointing Lead Member in case of JV
Annexure A8	Power of attorney for appointing signatory for the proposal
Annexure A9	Information of Litigation
Annexure A10	Proforma of Bank Guarantee for Bid Security
Annexure A11	Project Cost
Annexure A12	Means of Financing
Annexure A13	Net Worth & Net Cash Profits
Annexure A14	Details of all Works Similar Class Completed

Annexure A16	Project under Execution/Awarded
Annexure A17	Details of Executive & Personnel
Annexure A18	Details of Plants & Equipments
Annexure A15	Details of all Works Similar Class Completed with any other Construction Technology apart from Conventional Technology

Annexure A 19	Financial Qualification
Annexure 20	Project Summary

2.2 The Financial Plan to be submitted by the Bidder will outline over for the time allowed for completion in the form of following formats for:

- a) Project Cost, and.
- b) Means of Financing for the project.

The Bidder must fill all the information as required in the listed annexure formats Annexure A11-12) and present the same towards compliance of this section.

2.3 Bidders are allowed to tie up with JV (As per Tender) Members having specialized experience/expertise of relevance to the Project that is not available to the Bidder inhouse. The Bidders have to furnish an in-principle Memorandum of Understanding (MoU) / Letter of Association with the proposed JV Member for the experience/expertise of the JV Member to be considered. The coverage of the MoU is provided as Annexure A5.

2.4 In addition to the above, each Bidder is required to provide as part of the Technical Bid an estimate of the Total Project Cost and likely distribution of these costs across the proposed project components as per the formats provided in Annexure A-11.

Each Bidder shall also provide as part of the Financial Bid an overall financing plan showing the proportion of funding expected to be met through equity and debt.

However, if Bidder is not proposing any debt as a means of finance, Annexure A-12 may not be provided.

2.5 Company/JV details on Annexure-A4 with copy of Memorandum of Association/Article of association in case of companies and also copy of MOU/Agreement in case of JV.

2.6 Audited financial accounts of previous 5 Years.

IMPLEMENTATION CAPABILITY

2.7 This parameter pertains to demonstration of past technical strength and capability to execute the project collectively for the major components of the Development of Integrated Group Housing Facility **over 28542 Sqmt+73331** Sqmt of land at *FP 191 Gandhinagar, Chimni Tekro , Juno Depo & Islampura & F.P. No 45 , Javaharnagar , Nehrunagar , Salimnagar , Gousiya Masjid, Anjana* Such demonstration is expected through either in-

house experience OR experience of the JV members (maximum three allowed including Lead Member) OR experience of Alliance Partners entering into a Memorandum of Understanding with the Lead Member/Bidder.

a. Similar type of development of Residential/ Group Housing/ Commercial/ Retail projects and its marketing capability;

2.8 For demonstrating Implementation Capability, Bidder/s must fill all the information as required in the listed annexure formats (Annexure A14-A16) and present the same towards compliance of this section. The requirements and evaluation parameters for this section are discussed in greater detail below.

3 INSTRUCTIONS FOR FINANCIAL BID SUBMISSION

- 3.1 Although the financial bid will be submitted at the same time with technical bid, it will be opened only after completing the evaluation of technical bids. Prior to the detailed evaluation of the financial bid, SMC may determine whether each bid or bidder, as the case may be:
- (i) Continues to meet the eligibility criteria as given in this RFP;
 - (ii) Is in complete compliance with the Technical Bid requirements;
 - (iii) Has been properly signed and contains any required representations or commitments;
 - (iv) Is presented in a manner that matches with the requirements of the RFP and follows the required formats;
 - (v) Conforms to all terms, conditions, and specifications of the bidding documents without material deviation or reservation. A material deviation or reservation is one:
 - Which affects in any substantial way the scope, quality, or performance of the Project; or
 - Which limits in any substantial way, inconsistent with the bidding documents, SMC's rights or the Bidder's obligations under the Agreement;
 - Whose rectification would affect unfairly the competitive? Provision of other bidders presenting substantially responsive bids.
- 3.2 Each bidder shall indicate clearly in the financial bid the total amount of cost for SRS / highest net land premium **for 28542 Sqmt + 73331 Sqmt of land**. The figure shall be quoted in INR.
- 3.3 In case of tie among the bidders based upon the same quote, SMC may call / ask for a fresh and a sealed financial submission in the same manner as the original, only from such bidders (whose quotes have been found to be the same) on a fixed date and time as decided by SMC. In the fresh new financial submission, the Bidders must quote a figure higher than the figure quoted in the earlier financial bid.

- 3.4 The Preferred Bidder/Developer has the freedom to decide on the overall layout, design and architecture of the various components in the project subject to the specified development controls and obtaining of required approvals.
- 3.5 The intention to sign Development Agreement would be conveyed by SMC to the Successful Bidder whose bid has offered the Minimum total amount of cost of SRS / highest net land premium and who satisfies all other compliance requirements. Prior to expiration of the period of proposal validity, SMC will notify the Successful Bidder by registered letter that its bid has been accepted.
- 3.6 SMC reserves the right to accept or reject any proposal, and to annul the bidding process and reject all proposals, at any time prior to the award of Letter of Acceptance to the Preferred Bidder, without assigning any reason and without thereby incurring any liability to the affected Bidder or Bidders or any obligation to inform the affected Bidder or Bidders of the grounds for SMC's action.
- 3.7 After completing the evaluation of Financial Bid and identifying the successful bidder, SMC shall issue a Letter of Acceptance (LoA) to the Successful Bidder, indicating its intention for signing the Development Agreement. Within 30 days, upon issuance of such LoA to the Developer, the Preferred Bidder will be required to:
- 1/3rd Land Premium to SMC, in the form of a Demand Draft in favour of Municipal Commissioner, Surat , payable at Surat ; in case of positive land premium.
 - 0.25% of Project Cost to be payable to SMC before signing of Development Agreement;
 - Estimated Project Cost indicated in the Technical Bid of the Preferred Bidder will be adopted for this purpose.

4. SCOPE OF WORK

The work shall be executed on Turnkey basis from conception to commissioning services including soil investigation, all necessary engineering survey, construction, designing, method of erection in accordance with layout plan and detailed architectural / structural drawings duly approved as specified by SMC.

1. Scope of work contained in the paragraphs mentioned below is only indicative and not exhaustive. In addition the contractor/developer shall be responsible for executing all items required for completing the houses in all respect to make the dwelling units habitable and ready for occupation including all services, environment-fit for habitation with electrical, landscaping works complete as per direction of Engineer-in-charge.

Note: In addition to this, shops to be provided in case of commercial unit as per norms of GoG policy on slum rehabilitation, attached herewith. There may be increase in the No. of slum dwellers/Shops in slum so Contractor/developer/Developer shall have to carry out slum survey to verify the no. of residential units and commercial unit in the slums before submitting technical or financial bid.

1. Contractor/developer/Developer will have to prepare the layout plan and detailed architectural drawings to be approved as specified by SMC for this scheme within the development control norms attached in the tender documents and GDCR norms including all floor plans and other relevant details.
2. Contractor/developer/Developer will get the all the statutory clearance from the Prescribed Authority as and where required.
3. Contractor/developer/Developer will get the detailed soil investigation done as per relevant IS code, NBC 2005 etc. as applicable through any nationally accredited lab. The department may verify the results submitted by the agency, if need be.
4. Tender may satisfied himself by conducting pre soil test if he so required.
5. **Prepare complete structural design, drawing for foundation, super structure and for other related structures in the housing pocket i.e. UGRs, pump houses etc. to be provided in this housing scheme as per provision contained in IS code/ relevant codes.**
6. Provision of protection against seismic forces as per relevant IS codes for structure in Gujarat.
7. The structural drawing shall be approved as specified by SMC & charges if any shall be borne by the agency. If any modification in design/ drawing is needed, as per site conditions, the

agency shall do/ redo without any extra cost. The decision of the SMC shall be final and binding. No claim what so ever will be entertained in this regard.

8. Construction includes construction and finishing of the flats complete as well as related structure in this housing pocket as per specifications provided by SMC.
9. Planning, preparing drawing for internal services and execution of the same i.e. internal sanitary work, water supply work, drainage system etc. complete for the building including all pipes, its fittings, testing etc. complete.

11. Water supply:

Water supply lines will be laid as per scheme prepared, submitted by the contractor/developer and to be approved as specified by SMC.

- A. UGR of the required capacity/ of the quantity approved by SMC.
- B. Planning, designing and construction/ installation of underground reservoirs, water gallery pump houses for water supply, for fire-fighting tank including installing of pumps, standby pumps, DG sets, etc. as per approved drawings/ specifications or as directed by Engineer-in-charge.

12. Sewerage:

- A. Refuse area will be constructed in the building.
 - B. Internal storm water drain (pipe/ open surface drain) to be designed and constructed with Rain water harvesting system as per approved norms. Responsibility of getting storm water drain approved is included in the scope of work/tender.
13. Planning, designing and execution of all services like water supply, rain water harvesting system, sewerage, drainage system, roads, paths and all connected sub structures and super structures within the premises, as per bye laws and norms of the local bodies including making connections with the peripheral services after getting the services design approved from the local bodies/ Central Ground Water Board, SMC's role shall be limited only to sign the application/ drawings / documents for submission to the local bodies in the capacity of the owner for approval. In case of water supply and sewerage, the responsibility of getting the scheme approved from service provider (Municipal Corporation/ULB) is included in the scope of work/ tender apart from internal and external water supply/ sewerage & drainage lines to be laid to make the system of water supply and sewerage and drainage functional/ complete. However, the cost of connection of water supply lines/ sewer lines from peripheral connection point/ out fall sewer shall also be borne by agency. Infrastructure charges, if levied by the service provider (MC) towards cost

of laying of the peripheral services shall only be reimbursed by the SMC, on production of relevant documents to the satisfaction of SMC. It is also clarified that scope of work/ tender includes cost of getting the services approved from the services provider as aforesaid and the services charges including supervision charges, if any, payable to the service provider (MC)/DISCOM. The cost of deficiency charges and rectifications of any defect at the end of the job is also to be borne by the contractor/developer. Planning designing and execution of the roof top rain water harvesting system for recharge the sub soil water including laying of pipe lines and construction of substructure/ super structures.

14. Landscaping:

Preparation of landscaping plan including parks, plantation and execution of the same with following:

- A. The development of park: water hydrants, grassing creeper planting trees etc. complete as per Municipal Corporation/ULB norms as per specification and drawing approved by the prescribed authority of SMC.
 - B. Complete leveling/ dressing including filling of earth, its supply, disposal of surplus earth, (if any) shall be the property of SMC & will be disposed to the approved disposal point or at the place as directed by engineer in charge. No extra payment for disposal shall be allowed.
15. The disposal of construction and demolition waste shall be responsibility of contractor, but if required bt SMC disposal of same construction and demolition waste to the approved disposal point or at the place within the radius of 5.00 kms.(including necessary loading, unloading and carting required their of) as directed by EIC should be done.
 16. Planning, designing and construction of boundary wall for the whole scheme area, MS gate,, dustbin, sign boards, guide map, location board, direction boards, numbering of housing etc. All complete as per drawing approved by SMC.
 17. Setting of testing lab. At site, equipped with apparatus needed for testing during construction as per the list of laboratory equipments annexed with the NIT. 70% of the material shall be tested on site, 15% shall be tested in govt. lab, and 15% shall be tested in govt. approved lab.
 18. Taking all precautionary measure to safeguard against any accident for the contractor/ developers employees, general public, supervisory staff of SMC by providing necessary safety equipments, helmets and MS sheet barricading etc. at work site. The site has to be kept clean all the time of all debris, rubbish, dirt & surplus/waste material.

19. De-silting will also be done by the agency before handing over the completed housing pocket to SMC. All machine, equipment and labour for this purpose will be arranged by contractor/developer.
20. **The Contractor/developer will submit the model for layout of the project specifying details provided in layout along with in the tender documents in one month from stipulated date of start. He will also submit a model of modules of houses specifying all floors and its adjoining area. The scale of module shall be 1:500 for layout plant and 1:100 for dwelling unit.**
21. Contractor/developer will erect batch mix plant (minimum 30 cum/hr) fully automatic, computerized for preparation of Design mix concrete as per IS code at his own cost and will prepare all concrete accordingly.
22. Internal & external electrification work as per specification given in the tender document & directions of SMC as per scope of work & specifications appended with the NIT which includes L T supply, water supply arrangement, firefighting, lifts and DG sets, for both the interior and exterior of buildings.
- 23. Agency has to obtain labour licensee from Gujarat labour welfare board.**
24. Defect liability period would be uniformly seven years from the date of handing over the respective housing pocket complete in all respect & fit for occupation. However maintenance of other building activities, such as cleaning, sweeping of pocket & desilting of sewer lines, S.W. Drain shall be done only once prior to handing over the respective pocket. The maintenance will be only limited to removal of defects noticed in the works carried out by the agency during defect liability period.
25. The final ground level will be decided soon after actual start of work to avoid water logging at site. Plinth level of the houses shall be minimum (+) 600 mm above the nearby highest finished road level. Changes, if any, would not affect the agreed rates and no claim on this account shall be entertained.
26. The scope as described above is only indicative and not exhaustive. In additions to the above the contractor/developer shall be responsible for executing all the items required for completing the houses in all respect to make the dwelling units habitable and ready for occupation and also all services, make the environment fit for habitation with electrical, horticultural, rain water harvesting works complete as per direction of Engineer-in-Charge.

The above scope of work includes cost of all materials, manpower, equipments, T&P fixtures, accessories, royalties, taxes, watch & ward, and all other essential elements

for completion and maintenance of works as aforesaid whatsoever the approval accorded by SMC before acceptance of tender is only for tender Evaluation. Any change, modification, revision etc. required to be done by SMC, local bodies, project consultants etc. in accordance with applicable standards and tender document will have to be done at contractor/developer's cost and nothing extra shall be payable.

27. **Out of 36 months as stipulated period, the time limit for Planning & Designing shall be maximum 6 months. The remaining period i.e. 30 months will be for completion of entire work fit for habitation rehabilitation within 3 years from the 10th day of issue of work order.**
28. *The bidders are requested to submit Affidavit on Non Judicial Stamp Paper of Gujarat State only of Rs.100/- and duly notarized as per Annexure-21 attached herewith.*
29. *The bidders are requested to note and follow instructions as per Annexure-22 attached herewith.*

**Executive Engineer
Slum Upgradation Department
Surat Municipal Corporation.**

SIGNATURE OF THE CONTRACTOR/DEVELOPER.

DATE :

NAME AND ADDRESS :-

**FORMATS FOR GENERAL DOCUMENTATION
(Enclosed in Cover A under Section 1)
CONTENTS**

Section 1	General parameters and evaluation
Annexure A1	Covering letter for Envelope A
Annexure A2	Integrity Pact
Annexure A3	Letter of Transmittal
Annexure A4	Description of the Bidding Company, Project Experience & Financial Strength
Annexure A5	Letter of Acceptance/ Memorandum of Understanding (MoU) (applicable in case of JV)
Annexure A6	Bank Solvency Certificate
Annexure A7	Power of attorney for appointing Lead Member in case of JV
Annexure A8	Power of attorney for appointing signatory for the proposal
Annexure A9	Information of Litigation
Annexure A10	Proforma of Bank Guarantee for Bid Security
Annexure A11	Project Cost
Annexure A12	Means of Financing
Annexure A13	Net Worth & Net Cash Profits
Annexure A14	Details of all Works Similar Class Completed
Annexure A15	Details of all Works Similar Class Completed with any other Construction Technology apart from Conventional Technology
Annexure A16	Project under Execution/Awarded
Annexure A17	Details of Executive & Personnel
Annexure A18	Details of Plants & Equipments
Annexure A19	Financial Qualification
Annexure - 20	Project Summary
ANNEXURE-21	AFFIDAVIT
ANNEXURE-22	Instruction

ANNEXURE A1 – FORMAT OF COVERING LETTER FOR ENVELOPE A

(The covering letter is to be submitted by the Bidding Company or the Lead JV Member of a Bidding JV, along with the other documents required in Envelope A)

Date:

Place:

To
The Chief Accountant,
Surat Municipal Corporation
Muglisara, Surat

Sir,

Sub: *Technical Bid for Selection of Developer for Development of Integrated Housing Facility over 28542 Sqmt+ 73331 Sqmt of land at FP 191 Gandhinagar, Chimni Tekro , Juno Depo & Islampura & F.P. No 45 , Javaharnagar , Nehrunagar , Salimnagar , Gousiya Masjid, Anjana ,Surat ,Gujarat”on PPP/Turn Key Basis*

Please find enclosed one (1) original and one (1) copy of our Technical Bid in respect of the ***Selection of Developer for Development of Integrated Housing Facility 28542 Sqmt+ 73331 Sqmt of land at FP 191 Gandhinagar, Chimni Tekro , Juno Depo & Islampura & F.P. No 45 , Javaharnagar , Nehrunagar , Salimnagar , Gousiya Masjid, Anjana ,Surat ,Gujarat” on PPP/Turn Key Basis***, in response to and complying with the *Request for Proposal* ("RFP") Document issued by SMC. We hereby confirm the following:

1. The Bid is being submitted by *(name of the Bidding Company/Lead Member Company)* who is the Bidding Company / the Lead JV Member of the Bidding JV comprising *(mention the names of the entities who are the Member Companies)*, in accordance with the conditions stipulated in the RFP *(In case of a Bidding JV)*. Our Bid includes the Letter (s) of Acceptance in the format specified in the RFP, and the MoU (as per the principles stated in the RFP) between, *(mention names of the entities that are the Member Companies)*, who are the Member Company(s) as per the condition stipulated in the RFP.
2. We have examined in detail and have understood the terms and conditions stipulated for Qualification of the bidders in the RFP Document issued by SMC and in any subsequent communication sent by SMC. We agree and undertake to abide by all these terms and conditions.

3. The information submitted with respect to our qualification criteria is complete, is strictly as per the requirements stipulated in the RFP, and is correct to the best of our knowledge and understanding. We would be solely responsible for any errors or omissions in our Bid.
4. The Bidding Company/Bidding JV of which we are the Lead JV Member (strike out whichever is not applicable), satisfy the legal requirements and in our opinion by itself / along with its bidding partners meets all the eligibility criteria laid down in RFP.
5. A Power of Attorney, by all other Bidding Companies of the JV, appointing Lead JV Member, authorizing Lead JV Member Company to sign all Technical and Financial Proposals, hold negotiations with SMC and sign the Development Agreement, in respect of the Project, is included as part of the Proposal.
6. A Power of Attorney from the Bidding Company / Lead JV Member authorizing the undersigned as the Authorised Representative, Signatory and Contact Person who is authorized to perform all tasks including, but not limited to providing information, responding to enquiries, entering into contractual commitments on behalf of the Bidder etc., in respect of the Project is included as a part of the Proposal.

For and on behalf of :

Signature :

(Authorized Representative and Signatory)

Name of the Person:

Designation:

Enclosures: Power of Attorneys & other information as per RFP requirements

ANNEXURE A2- INTEGRITY PACT

Surat Municipal Corporation, hereinafter referred to as “The Principal” and _____ -
_____ hereinafter referred to as “The Bidder/ Contractor/developer
Preamble The principal intends in award, under laid down organizational procedures, contact for
_____. The principal values full compliance with all relevant laws of the land, rules,
regulations, economic use of resources and of fairness/ transparency in its Relations with its
Bidder(s) and / or contractor/developer(s) In order to achieve, these goals the principal will
appoint an Independent External Monitor (IEM), who will monitor the tender process and the
execution of the contract for compliance with the principals mentioned above.

Section1- Commitments of the principal

The principal commits itself to take all measures necessary to prevent corruption and to observe the following principals:-

1. No employee of the principal, person or through family members, will in connection with the tender for, or the execution of a contract, demand, false promise for or accept, for sell or third person, any material or materials benefit.
2. The principal will, during the tender process treat all Bidder(s) with equity and reason. The principal will in particular, before and during the tender process provide to all |Bidder(s) the same information and will not provide to any Bidder(s) confidential/ additional information through which the Bidder(s) could obtain an advantage in relation to the tender process or the contract execution.
3. The principal will exclude from the process all known prejudiced persons.
4. If the principal obtains information on the conduct of any of its employees which is a criminal offence under the IPX/PC, Act or if there be a substance suspicion in this regard, the principal will inform the Chief Vigilance Officer and in addition can initiate Disciplinary actions.

Section2- Commitments of the Bidder(s)/Contractor/developer(s)

1. The Bidder(s)/ contractor/developer(s) commit himself to take all measures necessary to prevent corruption. He commits himself to observe the following principles during the participation in the tender process and during the contract executions.
2. The Bidder(s)/Contractor/developer(s) will not enter with other bidders into any undisclosed agreement or understanding, whether formal or informal. This applies in particular to prices, specifications, certifications, subsidiary, contracts, submission or non-

submission of bids or any other actions to restrict competitiveness or to introduce castellation in the bidding process.

The Bidder(s)/contractor/developer(s) will not commit any offence under the relevant IPC/PC Act, further Bidder(s)/contractor/developer(s) will not use Improperly, for purpose of completion or personal gain, or pass on to others, any information of document provided by the principal as part of the business relationship regarding plans, technical proposals and business details, including information contained or transmitted electronically.

The Bidder(s)/contractor/developer(s) of foreign origin shall disclose the name and address of the Agents/ representatives in India, if any. Similarly the Bidder(s)/contractor/developer(s) of Indian Nationality shall furnish the name and address of the foreign principles, if any. Further details as mentioned in the “Guidelines of Indian Agents of Foreign Suppliers” shall be disclosed by the Bidder(s)/contractor/developer(s). Further as mentioned in the Guidelines all the payments made to the Indian Agent /representatives have to be in Indian Rupees only).

The Bidder(s)/contractor/developer(s) will when presenting his bid, disclose any and all payments he has made, is committed to or intends to make to agents, brokers or any other intermediaries in connection with the award of the contract.

The Bidder(s)/ contractor/developer(s) will not instigate third persons to commit offenses outlined above or be an accessory to such offenses.

Section 3- Disqualification from tender process and execution from future contracts.

If the Bidder(s)/contractor/developer(s) before award or during execution has committed a transgression through a violation of Section2, above or if any other form such as to put his reliability or credibility in question, the principal is entitled to disqualify the Bidder(s)/ contract(s) from the tender process or take action as per procedure mentioned in the guidelines on Banning of business dealings. It should be added that committing any offence incur any disqualification.

Section4-Compensation for Damage

1. If the principal has disqualified the Bidder(s) from the tender process prior to the award according to section3, the principal is entitled to demand and recover the damages equivalent to Earnest money Deposit/ Bid Security.
2. If the principal has terminated the contract according to section 3 or if the principal is entitled to terminate the contract according to section 3, the principal I shall be entitled to

demand and recover from the contractor/developer liquidated damages of the contract value or the amount equivalent to performance Bank Guarantee.

Section 5- Previous transgression

1. The Bidder declares that no previous transgression occurred in the last 3 years with any other company in any country confirming to the anti-corruption approach or with any other public sector Enterprises in India that could justify his exclusion from the tender process.
2. If the Bidder make incorrect statement on this subject, he can be disqualified from the tender process or action can be taken as per the procedure mentioned in “Guidelines on Banning of business dealings”

Section 6 - Equal treatment of All Bidders/ contractor/developers/ sub-contractor/developers.

1. The Bidder(s)/ contractor/developer(s) undertake(s) to demand from all sub contract commitment in conformity with this integrity pact and to submit it to the prime before contract signing.
2. The principal will enter, into agreements with identical conditions as this one Bidders, contractor/developers and sub-contractor/developers.
3. The principal will disqualify from the tender process all bidders, who do not sign Bidders, Contractor/developers and sub-contractor/developers.

Section 7- Criminal charges against violating Bidder(s)/contractor/developer(s)/ Sub contractor/developers If the principal obtains knowledge or conduct of a Bidder, contractor/developer or subcontractor/developer an employee or a representatives or an associate of a Bidder, contractor/developer or subcontractor/developer which constitutes corruption, or if the principal has substantive suspicion in this regarding principal will inform the same to the Chief vigilance officer.

Section8-Independent External Monitor/Monitors.

1. The principal appoints competent and credible independent External Monitor impact. The task of the Monitor is to review independently and objectively, whether to what extent the parties comply with the obligations under this agreement.
2. The monitor is not subject to instructions by the representatives of the party performs his functions neutrally and independently. He reports to the chairman.
3. The Bidder(s)/Contractor/developer(s) accept that the Monitor has the right part restriction to all project documentation of the principal including that provided. The

contractor/developer will also grant the Monitor upon his request demonstration of a valid interest, unrestricted and unconditional access to his documentations. The same is applicable to subcontractor/developers. The monitor contractual obligation to treat the information and documents of the Bidder|(s)/contractor/developer(s) sub contractor /developer(s) with confidentiality.

4. This agreement is subject to Indian Law. Place of performance and jurisdiction the Registered Office of the principal i.e. Surat.
5. Changes and supplements as well as termination not less need to be made writing. Side agreements have not been made.
6. If the contractor/developer is a partnership or a JV, this agreement must be signed by all partners of JV members.
7. Should one or several provisions of this agreement turn out to be invalid, the reminder of this agreement remains valid in this case, the parties will strive to come to an agreement to their original intentions.

**For & on behalf of the
Principal (office seal) Bidder/contractor/developer (office seal)**

Place-----

Date-----

Witness:1 (Name & Address)-----

Witness:2 (Name & Address)-----

ANNEXURE A3 - LETTER OF TRANSMITTAL

From:

To,
The Executive Engineer,
Surat Municipal Corporation
.....
.....,
.....,
.....

Subject: submission of Technical bid

Name of Work :-

SH: C/o _____

Sir,

Having examined the details given in pre-qualification press notice and prequalification document for the above work/we hereby submit the pre-qualification application and relevant documents.

1. I/we hereby certify that all the statements made and information supplied in the enclosed from "A" to "F" and accompanying statements are true and correct.
2. I/we have furnished all information and details necessary for pre-qualification and have no further pertinent information to supply.
3. I/we submit the requisite certified solvency certificate and authorize the Executive Engineer to approach the Bank issuing the solvency certificate to confirm the correctness thereof.

I/we also authorize Executive Engineer to approach individual employers, firms and corporation to verify our competency and general reputation.

4. I/we submit the following certificate in support of our suitability technical knowhow and capability for having successfully completed the following works.

Name of work:

Certificate from:

Enclosures:

Date of Submission:

SIGNATURE OF APPLICANT(S)

SEAL

ANNEXURE A4 – DESCRIPTION OF THE BIDDING COMPANY / BIDDING JV

Name of the Bidding Company / Bidding JV	
Name of the Lead JV Member (In case of Bidding JV)	
Address of the Lead JV Member and Contact Person, Phone/Fax Nos.	

(use a similar format for all other members also)

In case of a JV

Sl. No.	Name of each Member Company	Proposed % equity contribution into the Project	Role as per the MoU signed by and between all the Member Companies

(Signature of Authorized signatory)

ANNEXURE A5-FORMAT OF LETTER OF ACCEPTANCE.

(The Letter of Acceptance is to be submitted by each Member Company of the Bidding JV)

Date:

Place:

To

**The Municipal Commissioner,
Surat Municipal Corporation,
Muglisara, Surat.**

Sir,

Sub: *Technical Bid for Selection of Developer for Development of Integrated Housing Facility over 28542 Sqmt+ 73331 Sqmt of land at FP 191 Gandhinagar, Chimni Tekro , Juno Depo & Islampura & F.P. No 45 , Javaharnagar , Nehrunagar , Salimnagar , Gousiya Masjid, Anjana ,Surat ,Gujarat*”on PPP/Turn Key Basis.

This has reference to the Bid being submitted by (mention the Lead JV Member of the Bidding JV), as Lead JV Member of the Bidding JV comprising (mention name(s) of the Member Companies) in respect of ***Technical Bid for Selection of Developer for Development of Integrated Housing Facility over 28542 Sqmt+ 73331 Sqmt of land at FP 191 Gandhinagar, Chimni Tekro , Juno Depo & Islampura & F.P. No 45 , Javaharnagar , Nehrunagar , Salimnagar , Gousiya Masjid, Anjana ,Surat ,Gujarat*”on PPP/Turn Key Basis** in response to the Request for Proposal ("RFP") issued by SMC.

We hereby confirm the following:

- We (*name of the Member Company furnishing the Letter of Acceptance*), have examined in detail and have understood and satisfied ourselves regarding the contents including in respect of the following: The RFP Document issued by SMC;
- All subsequent communications between SMC and the Bidder, represented by (*Mention name of the Lead JV Member*);

- The MoU signed between / among (*names of the Member Companies*), as members of the Bidding JV; and
 - The Bid being submitted by (*name of the Lead JV Member*).
2. We have satisfied ourselves regarding our role as (*here give a brief description of the role*) in the Project as specified in the Bid. If the Bidding JV is awarded the Project we shall perform our role as outlined in the Bid to the best of our abilities. We have examined the Bid in detail and the commitments made in the same. We agree and undertake to abide by the Bid and the commitments made therein.
3. We authorize (*name of the Lead JV Member*), as the Lead JV Member and authorize the same to perform all tasks including, but not limited to providing information, responding to enquiries, entering into contractual commitments etc. on behalf of the JV, in respect of this Project.
4. We understand that, no change in the membership in the Bidding JV, in the role and form of responsibility of any Member Company shall be permitted after submission of the Bid. If any change in the membership of the JV is desired, it would need to be communicated to SMC in writing for its approval. SMC would reserve the right to reject such requests for a change of JV structure, if in its opinion, it would adversely affect the same.

For and on behalf of:

Signature:

(Authorized Representative and Signatory)

Name of the Person:

Designation:

ANNEXURE A6

FORM OF BANKERS CERTIFICATE FROM A NATIONALIZED BANK

(Solvency Certificate from a Scheduled Bank)

This is to certify that the best of our knowledge and information that M/S /Sh. _____
_____ having marginally noted address, a customer of
our bank are/is respectable and can be treated as good for any engagements up to a limit of
INR _____ (INR _____). This certificate issued
without any guarantee or responsibility on the bank or any of the officers.

(Signature) For the Bank

NOTE:

- Banker's certificates should be on letter head of the Bank, sealed in cover addressed to tendering authority.
- In case of partnership firm, certificate should include names of all partners as recorded with the Bank.

**ANNEXURE A7 – FORMAT OF POWER OF ATTORNEY FOR APPOINTING THE
LEAD MEMBER COMPANY.**

{On Requisite Stamp Paper}

KNOW ALL MEN by these presents that we, [name of the company], a company incorporated under the Companies Act 1956, having its Registered Office at [Address of the Company] (Hereinafter referred to as “Company”):

WHEREAS the Company along with _____ and _____ (give name and registered office address) is forming a joint venture to submit Technical and Financial Bids in response to the Request for Proposal (“RFP”) for **Selection of Developer for Development of Integrated Housing Facility over 28542 Sqmt+ 73331 Sqmt of land at FP 191 Gandhinagar, Chimni Tekro , Juno Depo & Islampura & F.P. No 45 , Javaharnagar , Nehrunagar , Salimnagar , Gousiya Masjid, Anjana ,Surat on PPP/Turn Key Basis** issued by the SMC and is desirous of appointing an attorney for the purpose thereof.

**Whereas the Company deems it expedient to appoint M/s. _____
(name of Company, registered office address) as the Attorney of the Company.**

NOW KNOW YE ALL BY THESE PRESENTS, that _____[name of company] do hereby nominate, constitute and appoint....[name the lead member company] as its true and lawful Attorney to do and execute all or any of the following acts, deed and things for the Company in its name and on its behalf, that is to say :

- To act as the Lead Member of the Joint Venture for the Purposes of the Project; In such capacity, to act as the Company’s official representative for submitting the Technical and Financial Proposals for the Project and other relevant documents in connection therewith;
- To sign all papers for all bids, offers, Project documents, necessary documents,papers, applications, representations and correspondence necessary and proper for the purpose aforesaid;
- To tender documents, receive and make inquiries, make the necessary corrections and clarifications to the Project documents, as may be necessary;
- To sign and execute contracts relating to the Project, including variation and modification thereto;

- To represent the Company at meetings, discussions, negotiations and presentations with SMC, City Administrations, Government Authorities, Competent Authorities and other Project related entities;
- To receive notices, instructions and information for and on behalf of the Company; To execute the Development Agreement for and on behalf of the Company;
- To do all such acts, deed and things in the name and on behalf of the Company as necessary for the purpose aforesaid.

AND the Company hereby covenants with the said Attorney to ratify and confirm all and whatever the attorney may lawfully do or cause to be done by virtue of these presents.

IN WITNESS WHEREOF the Company puts its hand and seal to this Power of Attorney on this ..
[day, month & year]

The common seal of [name of the company] was here unto affixed pursuant to a resolution passed at the meeting of Committee of Directors held on the _____ day of _____, **2017** in the presence of [name & designation of the person] and countersigned by [name & designation of the person] of the Company of [name of the company]

) The common seal of company [name of the Company)

)

)

)-----

) [name & designation of the person]

)

ANNEXURE A8 – FORMAT OF POWER OF ATTORNEY APPOINTING SIGNATORY

{On Requisite Stamp Paper}

KNOW ALL MEN by these presents that we, ...[name of the company], a company incorporated under the Companies Act 1956, having its Registered Office at [Address of the Company] (hereinafter referred to as “Company”):

WHEREAS the Company has been authorized by _____ and _____ (give names and registered office addresses), vide its respective power of attorney, to act as the Lead Member of the JV/Joint Venture bidding for the for ***Selection of Developer for the Development of Integrated Housing Facility over 28542 Sqmt+ 73331 Sqmt of land at FP 191 Gandhinagar, Chimni Tekro , Juno Depo & Islampura & F.P. No 45 , Javaharnagar , Nehrunagar , Salimnagar , Gousiya Masjid, Anjana ,Surat Gujarat on PPP/Turn Key Basis.***

WHEREAS in response to the Request for Proposal (RFP) for ***Selection of Developer for the Development of Integrated Housing Facility over ____ Sqmt of land at _____ on PPP/Turn Key Basis*** (“Project”), the Company is submitting Technical and Financial Bids on behalf of the Joint Venture for the Design, Develop, Finance, Construct, Market, Sub-Lease and Maintenance of the for ***Selection of Developer for the Development of Integrated Housing Facility over ____ Sqmt of land at _____ on PPP/Turn Key Basis*** issued by the SMC and is desirous of appointing an attorney for the purpose thereof.

Whereas the Company deems it expedient to appoint Ms./ Mr. _____ daughter/son of _____ resident of _____, holding the post of _____ as the Attorney of the Company.

NOW KNOW YE ALL BY THESE PRESENTS, that _____[name of the lead member company] do hereby nominate, constitute and appoint [name & designation of the person] as its true and lawful Attorney so long as she/ he is in the employment of the Company to do and execute all or any of the following acts, deed and things for the Company in its name and on its behalf, that is to say:

To act as the Company’s official representative for submitting the Technical and Financial Bids for the said ***Developer for the Development of Integrated Housing Facility over ____ Sqmt of***

land at _____ on PPP/Turn Key Basis and other relevant documents in connection therewith.

To sign all papers for all bids, offers, Project documents, necessary documents, papers, applications, representations and correspondence necessary and proper for the purpose aforesaid;

To tender documents, receive and make inquiries, make the necessary corrections and clarifications to the Project documents, as may be necessary;

To sign and execute contracts relating to the Project, including variation and modification thereto; To do all such act, deed and things in the name and on behalf of the Company as necessary for the purpose aforesaid.

The common seal of [name of the company] was here unto affixed pursuant to a resolution passed at the meeting of Committee of Directors held on the ___ day of _____, (year) in the presence of [name & designation of the person] and countersigned by [name &))))-----) [name & designation of the person])
---	--

designation of the person] of the Company of [name of the company]))-----) [name & designation of the person]
--	---

ANNEXURE A9 – INFORMATION ON LITIGATION

(To be provided for each firm/Joint Venture member)

Sl. No.	Name of bidding entity/Joint Venture Members	Name of agency with which litigation and brief subject	Estimated financial liability

Signature of Authorised Signatory

ANNEXURE A10 – PRO-FORMA OF BANK GUARANTEE FOR BID SECURITY

(To be executed on appropriate value of Non-Judicial Stamp Paper as per Stamp Act prevailing in the State of Gujarat)

WHEREAS, (name of the Bidder) wishes to submit his Bid for the **Selection of Developer for the Development of Integrated Housing Facility over 28542 Sqmt+ 73331 Sqmt of land at FP 191 Gandhinagar, Chimni Tekro , Juno Depo & Islampura & F.P. No 45 , Javaharnagar , Nehrunagar , Salimnagar , Gousiya Masjid, Anjana ,Surat, Gujarat . on PPP/Turn Key Basis**, hereinafter called "the Bid",

KNOW ALL MEN by these presents that we (name of bank) of (city and country) having our registered office at _____ (hereinafter called "the Bank") are irrevocably and unconditionally bound to the **Surat Municipal Corporation** or its successor, (hereinafter referred to as "SMC (short form)" in the sum of Rs. _____ (In Words) _____ which payment can truly be made to SMC.

The Bank binds themselves, their successors and assigns by these presents.

Sealed with the Common Seal of the Bank this _____ day of _____, _____.

THE CONDITIONS of this obligation are:

- (a) If the Bidder withdraws his Bid at any time during the stipulated period of Bid Validity specified in the Request for Proposal Document (or such period of validity as may be extended as per RFP, issued by SMC; or
- (b) If the Bidder, for the period of the Bid Validity as per RFP in SMC's opinion, commits a material breach of any of the terms and / or conditions contained in the RFP Document and / or subsequent communication from SMC in this regard; or
- (c) If the Bidder refuses to accept the correction of errors in the Bid; or
- (d) If the Bidder, having been notified of the acceptance of its Bid by the SMC: fails or refuses to sign the Agreement for the **Development of Integrated Housing Facility over over 28542 Sqmt+ 73331 Sqmt of land at FP 191 Gandhinagar, Chimni Tekro , Juno Depo & Islampura & F.P. No 45 , Javaharnagar , Nehrunagar , Salimnagar , Gousiya Masjid, Anjana ,Surat Gujarat on PPP/Turn Key Basis;**
 - (i) Fails or refuses to provide the performance security to the SMC in accordance with, and when required by (within the stipulated time), RFP Volume III.

- (ii) Fails or refuses to pay the Project Development Fees in accordance with and when required by the RFP Volume II (Instruction to Bidders);
- (iii) Material Variation / Material fact suppression etc;

We agree and undertake, absolutely, irrevocably and unconditionally make the above payments, as the case may be, the above amount without protest, delay or demur upon receipt of SMC's first written demand, without the SMC having to substantiate its demand, provided that in its demand the SMC will note that the amount claimed by it is due to it owing to the occurrence of one or more of the conditions set out above, specifying the occurred condition or conditions.

The Guarantee will remain in force up to and including the date of expiry of the period of Bid Validity as stated in the RFP Document or as extended by SMC at any time as per RFP, notice of which extension to the Bank being hereby waived. Provided however, that In the event that this Bidder is selected for award of the project through the issue of the Letter of Acceptance, the Bid Security shall remain in force until the provision of the Performance Guarantee and payment of the Project Development Expenses/ Fees by such Bidder.

OR

In the event this Bidder is not selected for award of the Project, the Bid Security shall remain in force up to and including a period of **45** days after the announcement of award of the Project to the Successful Bidder and the issue of the Letter of Acceptance awarding the same (provided, however, that in the event that the Bidder is declared Technically Non Responsive, then the Bid Security of such Bidder can cease to be in force upon return of the unopened financial proposals of his Bid).

Any demand in respect of this Guarantee should reach the Bank not later than the date of expiry (as defined above) of this Guarantee.

The jurisdiction in relation to this Guarantee shall be the courts of _____ and the Indian law shall be applicable.

SIGNATURE OF AUTHORISED

REPRESENTATIVE OF THE BANK : _____

NAME AND DESIGNATION : _____

SEAL OF THE BANK : _____

SIGNATURE OF THE WITNESS : _____

NAME OF THE WITNESS : _____

ADDRESS OF THE WITNESS : _____

ANNEXURE A 11 – ESTIMATED PROJECT COST

- A. The bidder shall submit its estimated quarterly distribution of costs with regard to the project.

Year Wise- Quarter Wise distribution of costs	Total Capital / Construction Cost of project (%)	Total Capital / Construction Cost of project (%)	Any Other Costs (please name the item for such costs)
Year 1			
Quarter 1			
Quarter 2			
Quarter 3			
Quarter 4			
Year 2			
Quarter 1			
Quarter 2			
Quarter 3			
Quarter 4			
Year 3			
Quarter 1			
Quarter 2			
Quarter 3			
Quarter 4			
Year 4			
Quarter 1			
Quarter 2			
Quarter 3			
Quarter 4			
Year 5			

Quarter 1			
Quarter 2			
Quarter 3			
Quarter 4			
Year 6			
Quarter 1			
Quarter 2			
Quarter 3			
Quarter 4			
TOTAL PROJECT COST			

Signature of Authorized Signatory

ANNEXURE A 12– MEANS OF FINANCING FOR PROJECT

- The RED/Bidder shall submit its estimated yearly distribution of financing Arrangement with regard to the project

Year Wise- Quarter Wise distribution of costs	Total Estimated Project Cost (%)	Equity (%)	Debt proposed to be taken by the developer
Quarter 1			
Quarter 2			
Quarter 3			
Quarter 4			
Quarter 5			
Quarter 6			
Quarter 7			
Quarter 8			
Quarter 9			
Quarter 10			
Quarter ...			
Quarter ...			
Quarter ...			
Quarter ...			
Quarter ...			
Quarter ...			
Quarter ...			
TOTAL			

Signature of Authorised Signatory

ANNEXURE A 13 – NET WORTH & NET CASH PROFITS

- The aggregate and average of Cash Profits as per the previous years audited annual reports presented in the following tabular format, and certified by a Chartered Accountant (CA). In case of JV of Firms, each member Firm to certify this information by the relevant CA. The copies of the relevant annual reports must be submitted to support the calculations or relevant CA certificate.
- Filling up of this format is a must, otherwise the proposal is liable for disqualification

S. No.	Name of Firm or JV members	Net Worth (INR Crore)	Net Cash Profits (INR Crore)
1.	(Name of Firm OR Lead Member of JV of Firms)		
2.	(Name of JV Member 1)		
3.	(Name of JV Member 2)		
	Aggregate for Biding Entity		

Signature of Authorized Signatory

This is to certify that the above information has been examined by us on the basis of relevant documents; books of accounts & other relevant information and the information submitted above is as per record and as per details annexed.

Signature, Address, Seal & Membership No. of Chartered Account

ANNEXURE A 14

DETAILS OF ALL WORKS SIMILAR CLASS COMPLETED (not less than Twelve storied & 35 mt height) DURING THE LAST FIVE YEARS ENDING LAST DAY OF THE MONTH.

Sr. No.	Name of Work/Project & Location	Owner or sponsoring Organization	Cost of works in crores	Date of commencement as per contract	Stipulated date of completion	Actual date of completion	Litigation/ arbitration pending / in progress with details*	Name and address / telephone of officer to whom reference may be made	Remarks
1	2	3	4	5	6	7	8	9	10

* Indicates gross amount claimed and amount awarded by the arbitrator, if any.

Signature of Authorised Signatory

ANNEXURE A 17.

DETAILS OF TECHNICAL AND ADMINISTRATIVE PERSONNEL EMPLOYED AT PRESENT AND TO BE EMPLOYED FOR THE WORK.

Sl. No.	Designation	Total number	Number available for this work.	Name.	Qualification.	Professional experience of details of work carried out.	How these would be involved in this work.	Remarks
1	2	3	4	5	6	7	8	9

Signature of Applicant

ANNEXURE A 18.

Details of construction plant & equipments likely to be used in carrying out work.

Sl. No.	Name of equipment	Nos.	Capacity of type.	Age	Condition.	Ownership status		Current Location	Remarks
						Presently Owned	Leased To purchased		
1	2	3	4	5	6	7	8	10	11
1	EARTH MOVING EQUIPMENT.								
2	Excavators (Various sizes.)								
3	EQUIPMENT FOR HOISTING & LIFTING								
	1. Tower Crane								
	2. Building hoist								
	3. Lift								
	EQUIPMENT FOR CONCRETE WORK.								
	1 .Concrete batching plant (Fully automatic of min 30 M3/hr capacity Age: Not more than 5 years).								
	2. Concrete pump.								
	3. a) Concrete transit mixer. b) Other equipment for transportation of concrete mix.								
	4. Needle Vibrator (Electrical)								
	5. Needle Vibrator (Petrol).								
	6. Table Vibrator (Electrical/Petrol).								
	7.Shutter Vibrator (Electrical/Petrol).								
	8. Concrete Mixer(Electrical/Diesel).								
	9.Bar bending machine.								
	10. Bar cutting machine.								
	11.Wood thickness planner.								
	12.Drilling machine.								
	13.Circular Saw machine.								
	14. Welding Generator.								
	15.Welding transformers.								
	16.Steel shuttering.								
	17.Steel shuttering scaffolding.(for high (rise building)								
	18.Grinding/polishing machine.								
4.	Equipment for Road work.								
	1. Road rollers.								

	2. Earth rammers.								
5.	Equipment for transportation.								
	1. Tippers.								
	2. Trucks.								
	3. Mobile Cranes.								
	4. Water Tanker								
6.	Pneumatic equipment.								
	1. Air Compressor (Diesel).								
7.	Dewatering Equipment.								
	1. Pump(Diesel).								
	2. Pump (Electrical).								
8.	Power equipment.								
	1. Diesel Generators.								
9.	Any other plant/equipment.								
	Steel centering & shuttering/form work/H-frame centering (ii) steel plate (at least 60% of plot area)								

Signature of Applicant

ANNEXURE A 19

Financial Qualification (For Bidder / Each Member of the JV)

The aggregate Net Worth as per the latest audited annual report should be presented in the following tabular format (in case of a JV the aggregate of the JV) The Net Worth should be calculated as per the formula given in this document.

The copies of the audited annual reports for last 5 (five) years must be submitted along with the statutory auditor's certificate.

Name of Bidder/ Each Member of the JV:

S.No.	Head	Indian Rupees
1	Paid up Share Capital	
2	Reserves and Surplus	
3	Subtotal (1+2)	
4	Revaluation reserve	
5	Miscellaneous expenditure to the extent not written off	
6	Subtotal (4+5)	
7	Net worth (3 – 6)	

Certificate:

We declare that all information stated in the table above are complete and absolutely correct.

Dated this ____ day of _____ 20__

For and on behalf of :

Signature :

(Authorised Representative and Signatory)

Name of the Person :

Designation :

Note: In case Members of a JV are aggregating their individual Net Worth to qualify, the above information must be provided separately for each Member strictly as per the specified format.

Annexure - 20
Project Summary:

Project Component for SRS	
Parcel A: Total Plot Area proposed for SRS (Sq. m.) (to be provided to the Private Developer through a Development Agreement)	
Total built up area for SRS (sq. m.)	
No of DU proposed	
Indicative BUA per DU (Sq. m.)	
Minimum carpet area for DU Proposed (sq. m.)	
No. of storey	
Permissible FSI	
No. of Shops proposed	
Indicative area of the shops (sq. m.)	
Community hall (Sq. m.)	
Common plot (Sq. m.)	
Area proposed for Physical Infrastructure facilities (Road, electricity, Water Sump, pump house etc.) (Sq.m.)	
Other Social infrastructure facilities (anganwadi/health center/primary school/others) (sq. m.)	
Parking (sq. m.)	
No of Transit accommodation proposed and Duration	

Signature, Address, Seal of Bidder

Parcel B : Total Plot area for land for free sale (Offered by the Private Developer as Freehold land for free sale Real Estate Development) in (sq. m.) (to be offered to the Private developer as freehold land)	
--	--

This is to certify that the above information has been examined by us on the basis of relevant documents; books of accounts & other relevant information and the information submitted above is as per record and as per details annexed.

ANNEXURE-21
AFFIDAVIT

Name of Work:- _____

- I, the undersigned, do hereby Certify that all the statements made in the required attachments are true and correct. I also understand in case of wrongful/false information, corporation is entitled to take any civil & criminal punitive action against me/us.

The undersigned also hereby certifies that neither our firm M/s _____ nor any of its constituent partners have abandoned any work in India nor any contract awarded to us has been rescinded during last five years, prior to the date of this bid,

- The undersigned hereby authorize(s) and request(s) any bank, person, authorities, government or public limited institutions, firm or a corporation to furnish pertinent information deemed necessary and requested by the SMC to verify our statement or our competence and general reputation etc.
- The undersigned understands and agrees that further qualifying information may be requested, and agrees to furnish any such information at the request of the SMC.

The SMC and its authorized representatives are hereby authorized to conduct any inquiries or investigation to verify the statements, documents, and information permitted in connection with this bid and to seek clarification from our bankers and clients regarding any financial and technical aspects. The Affidavit will also serve as authorization to any individual or authorized representative to any institute referred to in the supporting information, to provide such information deemed necessary and requested by representative of Surat Municipal Corporation to verify statements and information provided in the Tender or with regard to the resources, experiences and competence of the Applicant.

Signed by the Authorized signatory of the firm

Title of the Office

Name of the firm

Date:-

Note: - The affidavit format as indicated above to be furnished on the non-judicial stamp Paper of Rs.100 And duly notarized.

ANNEXURE-22

Instruction

- E.M.D. & Tender fee shall be submitted in electronic format only through online (by Scanning) while uploading the bid. This submission shall mean that E.M.D. & Tender fee are received for Purpose of opening the bid. Accordingly, offer/tender of those tenderers who's E.M.D & tender fee is received electronically, shall be opened. However, for the purpose of realization of EMD and Tender fee, bidder shall send the EMD as well as Tender fee in the required format in original through RPAD/Speed Post so as to reach the Accounts Department (Main Office) within 7 days from the last day of submission of price bid. Punitive action shall be initiated for not submission of EMD & Tender fees in original to Accounts Department (Main Office) by bidder including abeyance of registration and cancellation of E-Tendering code for one year. All documents in supporting of bid shall be in electronic format only through online (by scanning) during the bidding period & hard copy will not be accepted separately.
- All documents must be coloured scanned to be seen as original. Scanning in black and white or gray shall not be acceptable.
- All the documents must be notarized with clearly displaying Stamp, Number and Name of the notary.
“Following Documents shall only be submitted in HARD COPY to Surat Municipal Corporation by all bidders.
- Earnest Money Deposit as mentioned in the tender (i.e. D.D./Bank Guarantee)
Tender Fees as mentioned in the tender.
- Affidavit on Non Judicial Stamp Paper of Rs.100/-

Signature, Address, Seal of Bidder

ANNEXURE-23

(Authorised Representative and Signatory)

Name of the Person :

Designation :

Note: In case Members of a JV are aggregating their individual Net Worth to qualify, the above information must be provided separately for each Member strictly as per the specified format.

This is to certify that the above information has been examined by us on the basis of relevant documents; books of accounts & other relevant information and the information submitted above is as per record and as per details annexed.

Signature, Address, Seal & Membership No. of Chartered Account

SURAT MUNICIPAL CORPORATION

SLUM UPGRADATION DEPARTMENT



NAME OF WORK: Development of Integrated Group Housing Facility at T. P. Scheme No. 7 (Anjana), F.P. No. 191 Gandhinagar, Chimni Tekro , Juno Depo & Islampura & F.P. No 45 , Javaharnagar , Nehrunagar , Salimnagar , Gousiya Masjid, Anjana at Surat on Public Private Partnership (PPP) basis under Mukhya Mantri Gruh Yojana(Work No.1)

E- Tender

TENDER NOTICE NO : DC/SUC/12/2016-17

VOLUME-III : SPECIFICATIONS

SERIAL NO. OF THE WORK	:	1
DOWNLOADING OF TENDER DOCUMENTS STARTS FROM	:	Dt. 04/03/2017
DATE OF PRE-BID CONFERENCE	:	through e-mail before Dt. 15/03/2017
LAST DATE OF DOWNLOAD OF TENDER DOCUMENTS FROM website smc.nprocure.com	:	Dt. 06/04/2017 upto 17.00 hrs
LAST DATE OF SUBMISSION OF ONLINE TENDER	:	Dt. 06/04/2017 upto 18.00 hrs
LAST DATE OF SUBMISSION OF TENDER FEES, EMD AND OTHER DOCUMENTS IN HARD COPY	:	During Dt.07/04/2017 to Dt.13/07/2017 upto 17.00 hrs
ESTIMATED AMOUNT	:	Rs. 216,00,00,000.00

**TENDER TO BE SUBMITTED TO:
THE CHIEF ACCOUNTANT,
SURAT MUNICIPAL CORPORATION, MUGLISARA
SURAT – 395 003.
BY R.P.A.D. / THROUGH POSTAL AUTHORITY / SPEED POST ONLY**

**NAME OF WORK :- Development of Integrated Group Housing Facility at T. P. Scheme
No. 7 (Anjana), F.P. No. 191 Gandhinagar, Chimni Tekro , Juno Depo
& Islampura & F.P. No 45 , Javaharnagar , Nehrunagar , Salimnagar
, Gousiya Masjid, Anjana at Surat on Public Private Partnership
(PPP) basis under Mukhya Mantri Gruh Yojana(Work No.1)**

e-TENDER (Online) NOTICE NO. : DC/SUC/12/2016-17

WORK NO. 1

Last date of submission of online Tender :

On or before Dt.06/04/2017 up to 18.00 hrs

**Last date of submission of All necessary documents mentioned in Technical bid (if any),
Tender Fees, EMD and Other Documents in Hard Copy :**

From Dt. 07/04/2017 to Dt.13/04/2017 up to 17:00 hrs at the office of Chief
Accountant, Surat Municipal Corporation, Muglisarai, Surat- 395 003.

Earnest Money : **Rs. 216,00,000.00** should be paid in the form of Demand Draft
of Nationalized/ Scheduled Banks, payable at Surat only.

OR

50% amount shall be in the form of Demand Draft and 50 %
amount Shall be in the form of Bank guarantee of Nationalized/ Scheduled
Banks, payable at Surat only.

Tender Fee : **Rs. 18,000.00** should be paid shall be in the form of Demand
Draft of Nationalized/ Scheduled Banks, payable at Surat only.

Pre-Bid : Bidders shall have to post their queries on e-mail address
slumupgradation@gmail.com before Dt.15/03/2017 upto 17:00 hrs.

EXECUTIVE ENGINEER
SLUM UPGRADATION DEPARTMENT
SURAT MUNICIPAL CORPORATION

SIGNATURE OF THE CONTRACTOR/DEVELOPER.

DATE :

NAME AND ADDRESS :-

[TECHNICAL -BID]

NAME OF WORK : Development of Integrated Group Housing Facility at T. P. Scheme No. 7 (Anjana), F.P. No. 191 Gandhinagar, Chimni Tekro , Juno Depo & Islampura & F.P. No 45 , Javaharnagar , Nehrunagar , Salimnagar , Gousiya Masjid, Anjana at Surat on Public Private Partnership (PPP) basis under Mukhya Mantri Gruh Yojana(Work No.1)

Estimated Amount :- **Rs. 216,00,00,000.00**

E.M.D. :- **Rs. 216,00,000.00**

Tender Fee :- **Rs. 18000.00**

Receipt No. :- _____

Date :- _____

Issued to

CONTRACTOR _____

Issuing Office : Executive Engineer, Slum Upgradation Department,
Old Rander Zone Office, Tadwadi, Rander Road,
Surat Municipal Corporation,
Surat.

Signature & Date of the Issuing Officer :-

**Executive Engineer
Slum Upgradation Department
Surat Municipal Corporation.**

SIGNATURE OF THE CONTRACTOR/DEVELOPER.

DATE :

NAME AND ADDRESS :-

CONTENTS		
SR. NO.	PARTICULARS	PAGE NO.
	Volume III : Specifications	
	MINIMUM BUILDING SPECIFICATIONS	107
	SPECIFICATIONS FOR HORTICULTURE WORKS	113
	LIST OF MAKES	120
	IS CODES	124

Volume – III
SPECIFICATIONS

Minimum Technical Specifications (Conventional Technology):

1. RCC framed structure

- a. The detailed dimensions & mix of RCC to be adopted shall be as per approved structural design.
- b. Reinforcement of Fe 500 TMT steel – IS 1786:1985 (reaffirmed 2004).

2. Brick masonry wall / Block Masonry (AAC Block)

- a. Brick work in foundation and plinth using fly ash bricks in C:M 1:6 proportion and partition wall shall be in C:M 1:4 proportion.
- b. Above P.L. block masonry using 600/625 x 200/240 x 225mm/100mm thick AAC(Cellular) block [Autoclaved aerated block] (Conforming to IS: 2185, Part-III), using readymade premix tensile adhesive mixture / with RCC coping at interval directed and approved by EIC.

3. Internal finishes:

- a. For internal walls, single coat 15 mm thick lime finish plaster in cement mortar proportion of 1:4, with whitewash.
- b. For internal ceilings, single coat of minimum 6 mm thick lime finish plaster in cement mortar proportion of 1:4, with whitewash.
- c. Finishing with a floating coat of cement slurry mixed with admixture of lime or neeru in required proportion in cement mortar 1:3 (1 cement : 3 sand) including cost of scaffolding, curing etc. comp as directed by engr. in charge.

4. External Finishes:

- a. External double coat sand faced plaster
- b. Cement mortar proportion of 1:4 in the 15 mm thick for the first coat and 1:2 in 6 mm thick for the second coat
- c. Exterior colour with cement paint

5. Internal Flooring:

- a. 12"x12" ceramic flooring in all rooms, toilets, wash and common passages laid on bed of 25 to 50mm thick cement mortar 1:6 (1cement : 6coarse sand) finished with flush pointing in white cement.
- b. Glazed tile dado in toilets and wash up to 4 ft.

6. Staircase:

- a. Polished kota stone without skirting
- b. Finish plaster in riser
- c. Railing up to 1.15 m height – MS railing or parapet wall

7. Doors & windows:

- a. 35mm thick finished flush doors at all floor level including RCC frame including medium quality C.P. Finished fixture and fastening including one coat of primer and two coat of oil/ enamel paint as directed.
- b. Anodized aluminum fittings e.g. Tower bolts, handles, door stoppers, aldrops etc. will be provided.

- c. Anodized aluminum sliding bolts will be provided only at the entrance door with nickel plated MS pull lock bolts.
- d. Toilet doors are with PVC frames and shutters – sintex or equivalent
- e. Windows frame and shutter made of MS section frame with glazing and safety bar (4 mm thick).
- f. Ventilators made of MS section frame with glass louvers.

8. Kitchen:

- a. Kitchen platform in Kota stone with SS sink – with glazed tiles, dado in 600 mm height.

9. Waterproofing:

- a. Brick bat concrete as per specifications with china mosaic for waterproofing with min 10 years guarantee.

10. Plumbing:

- a. Water Closet squatting pan (Orissa type W.C. pan) at all floor levels size 580 mm x 440 mm.
- b. Wash, bath and kitchen with CP fitting tap.
- c. U-PVC pipe (SWR) confirming to IS no. 13592 (Type "B") of Prince/Supreme/ Jain make for soil and waste discharge system at all floor levels including all fixtures like bends, tees, shoe etc. jointed with resin of approved brand & manufacture.
- d. Wrapping jute string (Kathi) around the vertical PVC Pipes for concealing with cement plaster 20mm avg. thickness (CM 1 cement : 3 coarse sand) finishing.
- e. P.V.C. pipe (SCH-80) of prince/suprme/jain/astral make for water supply line at all floor level incl. fixture like bends, tees, shoe etc. jointed with resin of approved brand & manufacture.
- f. C.P brass screws down bib tap at all floor level polished bright.
- g. Gun metal check or non-return full way wheel valve at all floor level.
- h. U-PVC pipes of confirming to IS 13592 (Type A) of prince/supreme/jain make for rain water at all floor levels, including all fixtures like bends, tees, shoe etc. jointed with resin of approved brand and manufacture.
- i. P.V.C. tank - Rotationally molded HDPE storage tank ISI mark of Sintex or equivalent company incl. locking arrangement, outlet, inlet, overflow and wash out pipe arrangement

11. Electrical:

- a. Point wiring for Light, Fan, Bell and Primary point with 2-1.5 sq. mm & earth wire of 1.5 sq. mm. (green) both are of ISI marked 1.1 kv grade FRLS PVC insulated multi strand copper

wires, in following type of pipe to be erected concealed in / flushed on wall / ceiling, completed with 6A Tissino Type ISI marked flush type switch / bell push and accessories erected on Metal /PVC Box covered with 3 mm thick PC (Polycarbonate) / Acrylic sheet with necessary Lamp holder / ceiling rose /H.D. Connector as directed.

- b. Point wiring for Looped PLUG with tissino type single pole ISI marked Switch and Socket erected with necessary connections erected on wooden / Metal / PVC Box covered with 3 mm thick PC (Polycarbonate) / Acrylic sheet for open / concealed wiring for following size.
- c. One fan point two light point and one plug point in each room.
- d. Supplying, fixing & Erecting Mains with 1.1 KV grade FRLS PVC insulated ISI marked stranded Copper conductor wire in following type of pipe to be erected concealed in / flushed on wall/ ceiling, with 1.5 sq.mm copper conductor FRLS PVC insulated stranded wire of green colour for earth continuity of following size- with medium class rigid PVC pipe and accessories 2 wire 1.5 sq.mm.
- e. Providing and Fixing approved make Double Pole Plastic Switch and fuse 250V., 30A confirming to IS erected on Polished wooden block as directed
- f. Approved make (Crompton or Kirloskar make) self-priming domestic inbuilt Mono block Submersible Water Pump with 1 HP motor, suitable for operation on 230 volts, 50 cys, AC supply with metallic flange & M.S, impeller delivery & suction of discharge 150 LPM at 20 mt head suitable for 25mm/40mm dia delivery with panel board and motor starter etc. complete as directed.

12. Power Supply & Street Lighting:

- a. Electrical Substations.
- b. HT & LT cables and conductors as per IS codes.
- c. Distribution network, Poles, Feeder Pillar Boxes, Switchgears, circuit breakers, Service Lines, service connections, Meters, etc. as per IS codes.
- d. Street lighting network comprising poles, fixtures, lamps, switches, fuses etc. as per IS codes.

13. Boundary Wall with Gate:

- a. 1.5m high boundary wall constructed with BB Masonry or CC block with required no of MS gates of approved design.

14. Internal Roads, Parking & Paths:

- a. **Sub Grade:** Sub grade to be prepared by excavating earth to an average depth of 22.5 cm. dressing to complete and consolidating with road roller 8-10 tonne as per specification.
- b. **Road:** Concrete road as per IRC Standard
- c. **Surfacing:** Concrete surface, For external service like water supply or cabling. Concrete paver block may be provided.
- d. **Kerb Stone:** CC 1:2:4 Precast Kerb stone 0.3m long and 0.3m x 0.15 m section complete as per CPWD specifications a per direction of Engineerin-change.
- e. **Path:** 75mm thick CC paver block over 75mm thick CC 1:5:10 bed.

15. Others:

- a. Rain water harvesting is mandatory is each project.

GUARANTEE BOND TO BE EXECUTED BY CONTRACTOR/DEVELOPER FOR REMOVAL OF DEFECTS AFTER COMPLETION IN RESPECT OF WATER PROOFING WORKS.

The Agreement made thisday of.....Two thousand and.....between.....son of(hereinafter called the Guarantor of the one part) and the ULB/DA, WHEREAS THIS Agreement is supplementary to a Contract (Hereinafter called the Contract) dated..... And made between the GUARANTOR OF THE ONE part and the ULB/DA of the other part, whereby the Contractor/developer, interalia, undertook to render the buildings and structures in the said Contract recited completely water and leak- proof.

AND WHEREAS THE GUARANTOR agreed to give a Guarantee to the effect that the said structures will remain water and leak- proof for Ten years to be reckoned from the date after the Maintenance Period prescribed in the Contract.

NOW THE GUARANTOR hereby guarantees that water proofing treatment given by him will render the structures completely leak- proof and the minimum life of such water proofing treatment shall be Ten years to be reckoned from the date after the maintenance period prescribed in the Contract.

Provided that the Guarantor will not be responsible for leakage caused by earthquake or structural defects or misuse of roof or alteration and for such purpose:

Misuse of roof shall mean any operation which will damage water proofing treatment, like chopping of firewood and things of the same nature, which might cause damage to the roof; Alteration shall mean construction of an additional storey or a part of the roof or construction adjoining to existing roof whereby water proofing treatment is removed in parts; The decision of the Engineer-in-charge with regard to cause of leakage shall be final.

During this period of guarantee, the Guarantor shall make good all defects and in case of any defects being found, render the building water proof to the satisfaction of the Engineer-in-Charge at his cost and shall commence the work for such rectification within seven days from the date of issue of the notice from Engineer-in-Charge calling upon him to rectify the defects failing which the work shall be got done by the Department by some other Contractor/developer at the GUARANTOR'S risk and cost. The decision of the Engineer-in-Charge as to the cost, payable by the Guarantor shall be final and binding.

That if, Guarantor fails to execute the water proofing or commits breach there under then the Guarantor will indemnify the Principal and his successors against all loss, damage, cost, expense or otherwise which may be incurred by his by reason of any default on the part of the GUARANTOR in performance and observance of this Supplementary Agreement. As to the amount of loss and/or damage and/or cost incurred by the ULB/DA, the decision of the Engineer-in-Charge will be final and binding on the parties.

IN WITNESS WHEREOF these presents have been executed by the Obligor _____ and by _____ and for an on behalf of the ULB/DA, on the day, month and year first above written.

SIGNED, SEALED AND DELIVERED BY OBLIGATOR IN THE PRESENCE OF –

C) _____

D) _____

SIGNED FOR AN ON BEHALF OF ULB/DA BY _____ in the presence of

1. _____

2. _____

Site of work shall have a Laboratory equipped with the following equipments:

- Balances:
 - 7 kg. to 10 Kg. capacity, semi-self-indicating type, accurate to 10gm.
 - 500 gm. Capacity, semi-self-indicating type, accurate to 10gm.
 - Pan Balance Type –5 Kg., accurate to 10gm.
- Ovens:- Electrically operated, thermostatically controlled upto 110C - sensitivity1C
- Sieves: as per IS: 460
 - IS Sieve – 450mm internal dia. of sizes – 100mm, 80mm, 63mm, 50mm, 40mm, 25mm, 20mm, 10mm, 6.3mm, 4.75mm completed with lid and pan.
 - IS Sieves – 200mm internal dia. (brass frame) consisting of 2.36mm, 1.18mm, 504 microns, 425 microns, 300 microns, 212 microns, 150 microns, 90 microns, 75 microns, with lid and pan.
- Sieve shaker capable of 200mm and 300mm dia. Sieves, manual operation with timing switch assembly.
- Equipment for slump test – slump cone, steel plate, tamping rod, steel scale, scoop.
- Dial gauges – 25mm travel – 0.01mm / division least count – 2 Nos.
- 100 tonnes compression testing machine, electrical-cum-manually operated.
- Graduated measuring cylinders, 200ml capacity – 3 Nos. broken one, if any to be replaced by the contractor/developer at his own cost.
- Enamel Trays (For efflorescence test) of bricks:-
 - 300mm x 250mm x 40mm – 2Nos.
 - Circular plate of 250mm dia. –4 Nos.
- 15cm moulds for concrete cubes – adequate numbers.
- Other instruments like steel tapes – 3m & 30m, Vernier Caliper's, a good quality plumb bob, spirit level minimum 30cm long with 3 bubbles for horizontal vertical, wire gauge (circular type) disc, foot rule, long nylon thread, magnifying glass, screw driver 30 cms long, ball pin hammer 100 gms, plastic bags for taking samples etc.
- Micrometer screw 25mm gauge.
- Rebound hammer for testing concrete dynamic penetrometer.
- Moisture meter for timber.
- Any other testing equipment/ machine required for testing of various other materials shall also be provided installed at the site lab with the technical staff well trained to operate such equipment/ machine.

SPECIFICATION FOR HORTICULTURE WORKS

- The work will be carried out as per CPWD specification 2009 Vol.I &II with up to date correction slips.
- The all liabilities of the labour is the responsibilities of the contractor/developer and that of not of ULB/DA.
- 250 Nos. of trees, 1000 Nos. of shrubs, 2500 nos. of hedge plants, creeper etc. will Be planted / hectare. List enclosed.
- At least 225mm good earth will be provided by the contractor/developer for lawn area and 25mm cow dung manure.
- At least one tube well required with pump houses with irrigation system for lawn area and planters etc. the maximum distance of the hydrant of 20mm size will be 25mtr.
- Green area will be bounded by 60cm. high boundary wall from adjoining path/Road and 1 mtr. Height railing over this wall.
- The contractor/developer shall arrange his own T&P required for development as well as maintenance.
- Tree plants will be protected by the tree guard.
- Tree/shrub/creeper/hedge plant will be approved by the Engineer-in-charge from the enclosed list.
- The quantity can be increased or decreased by 20% as per sole discretion of Engineer-in-charge.
- Trenching in ordinary soil up to a depth of 30cm. including removal and stacking of serviceable materials and then disposing of spreading an neatly leveling with an a lead of 50m and making up the trenched area to proper levels by filling with earth or earth mixed with sludge or/and manure before and after flooding trench with water.
- Supplying and stacking of good earth at site including royalty and carriage up to all leads and lifts.
- Supplying and stacking cow dung at site including royalty and carriage up to all leads and lifts.
- Fine dressing the ground to levels specified.
- Spreading of cow dung manure or/and good earth in require thickness.
- Grassing with 'doob' grass including watering and maintenance of the lawn for till the grass forms a thick lawn free from weeds and fit for moving including supplying good earth if needed. Grass to be planted in rows 5cm. apart in either direction.

- Preparation of beds for heading and shrubbery by excavating 60cm. deep and trenching the excavated based to a further depth of 30cm, refilling the excavated earth after breaking clods and mixing with cow dung manure in the ratio of 8:1(8part of stacked volume of earth after reduction by 20%:1 part of stacked volume of cow dung manure after reduction by 8%) flooding with water, filling with earth if necessary, watering and finally dressing, leveling etc. including stacking and disposal of materials declared unserviceable and surplus earth by spreading and leveling as directed within lead of 50m, lift upto 1.5m complete.
- Digging holes in ordinary soil and refilling the same with the excavated earth mixed with manure of sludge in the ratio 2:1 by volume (2 part of stacked volume of earth after reduction by 20%:1 part of stacked volume of cow dung manure after reduction by 8%) flooding with water dressing including removal of rubbish and surplus earth, if any with all leads and lift (cost of manure sludge or extra good earth, if needed is to be provided without any extra cost).
 - Holes 0.90m dia and 0.90m deep.
 - Holes 60cm. dia and 60cm. deep.
- Supplying best quality grown healthy trees in pot of 90-120cm height, species as specified. All trees to be approved before planting.
- Supplying best quality, pots grown healthy climber plants with minimum 90cm Stem length of species specified, inclusive of preparation and cultivation. All plants to be approved before planting by Dir. (Hort).
- Supplying best quality pot grown healthy climber plants with minimum 60cm. tail of species specified inclusive of preparation and cultivation of shrub beds as specified. All plants to be approved before planting by Dir. (Hort).
- Supplying and applying chemical emulsion of approved quality in sealed container for terminators 50ml. per sq. m. Including delivery as specified.
- Providing and fixing of M.S. circular tree guard 40cm. internal dia. With over all height of 1.82m. Frames at 3 nos. of vertical angle iron size 25x25x3mm with 75mm slatted bottom ends, welded full in length at meeting point with 3 nos. MS flat rings made of 25mmx3mm including welding and fixing steel wire mesh fabric of 1.30m high and 10 SW gauge of 5.0x7.5cm size wire mesh including painting with ready mixed paint of approved brand and manufacture and require shade over a priming coat of ready mixed zinc chromate yellow primer complete in all respects, as per drawing and direction of Engineer-in-Charge.

GENERAL SCOPE

All plant materials shall be healthy sound vigorous free from plant diseases insect, pests, or their eggs and shall have healthy, well-developed root system. All plants shall be hard under climatic conditions, similar to those in the locality of the project. Plants supplied shall conform to the names listed on both the plants and the plant list. No plant material will be accepted if branches are damaged or broken. All material must be protected from the sun and weather until planted.

All necessary stock shall be inspected and approved by the Director, landscape. Architect/Engineering-in-charge/Director. All plants shall conform to the requirements specified in the plant list, except that plants larger than specified may be used, if approved but use of such plant shall not increase the contract price.

If the use of such the large plant is approved, the spread of roots or ball of earth shall be increased in proportion to the size of the plant. Plants to be deliver with legible identification labels.

Topsoil: (Good earth PH. Range from 6.5 to 7.5).

Top soil or good earth shall be a friable loam typical. It shall be free of subsoil stones earth clods, sticks roots or other objectionable extraneous mater of debris. It shall contain no toxic material. No topsoil shall be delivered in a muddy condition. The PH value of the soil in between 6.5 to 7.5.

Fertilizer:

Dry farm yard manure shall be used. Measurement shall be in stacks with 8% reduction for payment. It shall be free from extraneous material harmful bacteria insects or chemicals.

Root system:

The root system shall be conducive to successful transplantation. Where necessary the root ball shall be preserved by support with hessian or other suitable material. On soils where retention of a good ball is not possible the roots should be suitable/protected in some other way which should not cause any damages to roots.

Marking:

Each specimen of tree and shrub, or each bundle, shall be legibly labeled with the essential particulars.

Tree planting:

Trees should be supplied with adequate protection as approved. After delivery, if planting is not to be carried out immediately, balled plants should be placed check to check and the ball covered with sand to prevent dying out. Bare rooted plants can be heeled in, by placing the roots in a prepared trench and covering them with the earth which should be watered in, to avoid air pockets around the roots.

Planting:

No tree pits shall be dug until final tree positions have been pegged out for approval. Care shall be taken that the plant sapling when planted is not buried deeper than in the nursery, or in the pot/polythene bag. Planting should not be carried out in water logged soil.

Plants/ trees at the original soil depth, the soil marks on the stem is an indication of this, and it should be maintained on the finished level allowing for setting on the soil after planting. All plastic

and other imperishable containers should be removed before planting. Any broken or damaged roots should be cut back to sound growth.

Fertilizing:

Fertilizing shall be carried out by application of chemical (NPK) fertilizers @ 1 quintal per acre per year in the end of winter.

Organic well-rooted dry farmyard manure 0.05 cum. or 1 (one) 'tassla' Urea 25 gm Or Potassium Sulphate 25gm.

All shrubs which are supplied pot grown shall be well soaked prior to planting. Watering in and subsequent frequent watering of summer planted container grown plants is essential.

In the absence of rain, in the Monsoon, the lawn shall be watered with sprinklers every three days, soaking the soil through to a depth of at least 20cm.

Damage failure or dying back of grass due to heat etc. Shall be the responsibility of the contractor/developer.

The contractor/developer is to exercise care in the use of rotary cultivator and mowing machines to reduce to a minimum, hazards of flying stones and brickbats. All rotary mowing machines are to be fitted with safety guards.

Nursery stock:

Planting should be carried out as soon as possible after the plant material has arrived at the site. Where planting is delayed, care should be taken to protect the plants from pilfering or damage from people or animals. Plants with bare roots should be heeled-in, as soon as received or otherwise protected from drying out, and others set closely together and protected from the wind and frost. If planting is to be delayed for more than a week packaged plants should be unpacked, the bundles opened up and each group of plants separately and clearly labeled. If for any reason, the surface of the roots becomes dry, the roots should be thoroughly soaked before planting.

A "NO Claim Certificate" in the prescribed form or a list of claims not included in the final bill with full details.

The Engineer-in-charge shall examine and certify the final bill for payment after satisfying that the works have been satisfactorily completed and that all properties, works and things removed or disturbed or damaged in consequences of the works, have been properly replaced and made good, and all expenses and demands incurred or made by one company or in respect of any damage or loss by/ from or consequences of the works have been satisfied, all materials have been returned and the site cleared.

Completion Certificate:

The works shall be deemed to have been completed in all respects, on the day the Engineer-in-charge certifies that the work have been so completed in accordance with this contract, take over the completed works and issues a certificate to that effect. The defect liability period will start from the said date of completion/handling over of the work.

Penalty:

If, at any time during the tenure of the contract, it is found that any material like manure, sweet earth etc. has not been brought/less quantities utilized in the work-than specified, the cost of the difference of materials less brought/utilize will be deducted as under:

- The cost of the material will be worked out at current market rate as assessed by the Engineer-in-charge adding 30% (thirty percent) extra of above cost as departmental overhead charges.
- Once this cost deduction is made as above from the bill. in no case the same will be refunded.

Contractor/developer's Co-ordination:

If during the course of the contractor/developer's work, other works of the department or of the other contractor/developers are also in progress within the same site, the contractor/developer is to use his best efforts to work in harmony with all the others and in the best overall interest of the Project/Work.

The payment of all the horticulture works/items as mentioned above will be made of actual work done and will deemed to have been including in the quoted tendered amount.

LIST OF TREES:

- Saptparni
- Neem
- Sisam
- Jambu
- Gulmohar
- Garmalo
- Sevan
- Kadam
- Desi Asopalav
- Pipal
- Badam
- Any other (suitable to the local climate)

LIST OF SHRUB:

- Bougainvillea (Varieties)
- Hibiscus rosasinensis
- Indian oleander
- Any other (suitable to the local climate)

LIST OF CREEPERS:

- Indian Vernonia
- Any other (suitable to the local climate)

LIST OF GROUND COVER:

- Altermanthera (Red)
- Alternanthera (Green)
- Asparagus sprengeri
- Lantana depressa.
- Any other (suitable to the local climate)

Maintenance for Work of Lawns

The grass in lawns shall regularly cut with garden swords and moved with lawn mowers. The thickness of the grass shall not be allowed to increase beyond 60mm. The minimum thickness of grass shall be maintained as 50mm. The thickness shall be measured from top of the soil surface. The grass shall also be kept free from all kinds of weeds.

The grass lawns shall be kept constantly rolled to give cushioning effect to the grass. Manuring of the grass lawns shall also be done regularly so as to keep the grass green. The manuring of the lawn shall be spread in the months of December and January or as directed by the Engineer-in-charge.

For maintenance of curbing for the fire control measure:

- The grass in area shall regularly be cut with garden swords and mowed with lawn mowers. The thickness of the grass shall not be allowed to increase beyond 60mm. The minimum thickness of grass shall be maintained as 50mm. Thickness shall be measured from top of the soil surface. The grass shall also kept free from all kind of the wild grass/bushes.
- The existing grass shall be scrapped, if required or as directed by the Engineer-in-charge. The scrapped materials shall be disposed of at convenient point to be decided by the Engineer-in-charge. Thereafter, the area will be suitably flooded with water and left for a fortnight for new grass to come up.
- Manuring of the grass area shall also be spread in the month of December/January or as directed by the Engineer-in-charge.

For work of Tree Plants and Trees:

- The area around the tree plants up to a minimum of two feet around, from trunk of the tree plants shall be kept free from grass and all kinds of weeds. Hoeing of this area around the trees shall be done regularly. The plants shall also be watered regularly as required and as directed by the Engineer-in-charge. Hoeing shall also be done after every watering as per the direction of Engineer-in-charge. For proper upkeeps of the tree, unwanted branches of the trees/tree plants shall be removed at regular intervals as required and as directed by the Engineer-incharge. The tree plants/trees shall also be kept free of any diseases, insects

or pest by regularly spraying insecticides as required and as directed by the Engineer-in-charge.

- The complete area where the tree plants/trees are planted in open field shall be kept free from grass and all kinds of weeds throughout the year.

For work of Hedges:

- The area around hedges plants shall be kept free from all kids of grass and weeds. Hoeing of the area around hedge plants shall be done regularly as required and as directed by the Engineer-in-charge. The hedge plants shall be watered regularly as required and as directed by the Engineer-in-Charge. Pruning and trimming are the most important items for proper shaping of hedges, therefore, special care and attention shall be paid to prune and cut the hedge as required and as directed by the Engineer-in-charge.

For work of flower beds:

The contractor/developer will maintain seasonal flower beds and rose beds including preparation of bed, supply of seeds and seeding chemicals, cow dung manure, watering, interculturing etc. as per direction of the Engineer-in-charge so that maximum healthy flowers/plants are available throughout the year for flowerbeds as per the requirement. In case any casualty flower due to negligence or poor maintenance by the contractor/developer occurs the same will be replaced by a healthy and acceptable plant, as per the direction of Engineer-in-charge.

OTHER SPECIFICATIONS

The following yardstick should be followed to maintenance of horticulture works.

- Minimum one Mali for one acre on lawn.
- Minimum one Mali for 250 nos. of road side trees/plants.
- Minimum one Mali for 3000 running meters of hedges.

List of Makes:

1.	Ordinary Portland Cement	Ambuja, Ultratech, Sanghi, Hathi, JK Laxmi-OPC 53 Grade,
2.	White Cement	J.K. White, Birla White, Nihon White
3.	Reinforcement Bar	TMT bars Fe-500 conforming to IS-1786-1985(reaffirmed 2004) TATA, SAIL,RINL,Electrotherm, National, JSW. (Only TMT Steel Shall be used.)
4.	Structural Steel	SAIL,TISCO, ISCO, Vizag, Asian Conforming to relevant IS code.
5.	Teak Wood	Bulsar/ C.P Teak (Second Class specified)
6.	Sal Wood	Sal wood [Indian or Imported] First class
7.	Kota Stone / Marble /Granite / Jaisalmer Stone	Minimum thickness of Kota stone should be 22.00 mm & as per approved sample.
8.	Ceramic Tiles (White, Colored, Anti-Skid)	Bell Ceramics, Somani, Kajaria, Nitco, Cera, Johnson, Asian, Euro, Restiles
9.	Vitrified Tiles (White, Colored, Anti-Skid)	Bell Ceramics, Somani, Kajaria, Nitco, Cera, Johnson, Asian, Euro, Restiles, Granamite
10.	Chequered Cement	Nitco, NTC, Kajaria, Vyara

	Tiles / Decorative Tiles	
11.	White Glazed Tiles	'H & R Johnson', 'Somani ', Nitco, Cera, Bell, Kajaria, Asian
12.	Interlocking paver Blocks	Regency, Gurjari, Vyara, PEEDEE, Jagruti - Surat or as approved by EIC/consultant
13.	Plywood Products Commercial Block Board Commercial Ply Teak Ply	Greenply, Kitply /Century, Anchor, Duro, Western India plywood (WIP). Mysore marine.
14.	Laminates / Decorative Laminates	Decolam, Greenlam Merinolam Formica, National laminate, Decolite, Delta.
15.	Pre laminated board	Bhutan, Eco board, Bakelite Hylem Nepal board, Green board.
16.	Impregnated Fibre Board	Shalitek by Shalimar Tar Product.
17.	Teak Veneer	Anchor, Kitply or equivalent
18.	Flush Doors Conforming to IS-1003 Part -1,1991	'Sitapur plywood', 'Mysoboard', Sudarshan W & P Industries, Bajwa, Baroda, Goyal, industrial corp, Wood craft, Jain wood industries, Alpro, Genda- Northen Doors, Greenply, Kitply, Bhutan.or equivalent as approved by EIC.
19.	PVC Doors (PVC material Conforming to IS-10151-1982)	Sintex, Rajeshree , Kaka. Or as per approved by EIC.
20.	Aluminium Section	Hindal, Jindal, Banco, Hindalco
21.	All Aluminium Hardware, Fittings	Everite, Garnish, Arches, Kausal, Nulite Alif, Shalimar (Bombay) Singla, Opel, Bolt, Arhish
22.	Aluminium Doors, Windows, Partitions Fabricators	As approved by EIC/Consultant
23.	Stainless Steel Hardwares Fittings	Kitch, Dorma
24.	Glass/Float/Sheet	Saint Gobain, Modi, Hindustan Pilkington , Hindustan , Tata, Asahi, Triveni, Shree Vallabh
25.	Door Closer / Floor Spring	Godrej / Everite, Opel, Doorking/ Hardwin, Nulite, Hyper, Ezec,
26.	Locks	Godrej, Harrison, Plaza, Golden, Doorset
27.	Friction Hinges	Imax, EBCO
28.	Rolling Shutters	' Standard', 'Swastik', 'Diana', 'Hercules', As per approved fabricator.
29.	Polysulphide Sealant For Expansion Joints All Windows	Chokesy Chemical, Structure Proofing Co Pidilite, GESilicon, Tuffseal
30.	Synthetic Enamel Paints / Oil bound Distemper	ICI/Dulux, Johnson & Nicholson, Asian Paint, Dulux
31.	Water Proof Acrylic Paints / Weather proof Acrylic Paints	'Super Snowcem', Supercem, Asian, Nerolac, Berger, Dulux
32.	Plastic Emulsion paint	J & N, ICI, Asian, Berger, Dulux
33.	Dry Distemper / Oil Bound Distemper	Shalimar', ICI', 'Goodlass Nerolac', , Berger, Johnson & Nicholson, Asian Paint, Dulux
34.	Duco Spray Paint	ICI or equivalent
35.	Polyurethane Paint	MRF or equivalent
36.	Water Proofing Compound	' CICO' , Fosroc, GE silicon Pidilite, MC-Bauchmie, Sika, roff , perma
37.	Weather Sealent / Silicon sealent / Poly isobutylene	Fosroc, Pidilite, MC-Bauchmie, Wecker 789, Dow corning 789 or

	sealant	Equivalent
38.	Hardeners	'Ironite', 'Ferrok', 'Hardonate'.
39.	Wire Mesh	Sterling Enterprises, Trimurti, Welded Mesh.
40.	Anti-Termite Treatment	Thyodin by Hoechst, Lyntric by Bayer India, Durmet by Cynamid India, Nocil Pyramid, item sycour.
41.	Polycarbonate Sheets	Lexan, GE or approved by EIC.
42.	M.S. Tubes	TATA, zenith ,asian , Jindal
43.	Aluminium Composite Panel	Flexibond-Umiya Flexifoam Pvt. Ltd., Aludecor Lamination Pvt. Ltd., Indobond-ACP Marketing Pvt. Ltd., Eurobond, Ultrabond, Durabuild, Ultra panel
44.	Pre coated Sheets	Tata Blue scope, Multicolor steels, Interarch, Kirby, Tiger steel
45.	Lift/Elevators	Otis, Kones, Schindler, Mitshubishi, Thyssun Krupp, Trio, Techno.
46.	Polyester Fibre	Recron 3S or approved by EIC.
47.	Welding Rod	Advani, Philips, Sunarc, Eshab
48.	Fly Ash Bricks	As Approved by EIC/ Consutant.
49.	AAC BLOCK (confirming to IS : 2 185,Part - 3	Aerocon, Magicrete,Biltech,Litecone,Ecolite,Xtralite,Anjani,Globcon make (autoclaved aerated block) or as approved by EIC/Conslutant.
50.	Construction Chemicals	Fosroc, MC-Bauchmie, Sika, Pidilite, Roff, perma.

1	Cast Iron Pipes and Fittings (LA Class)	TISCO / ISCO/ KESHO SPUN Co. - Calcutta E.L.C. Standard approved manufacturers of any other brand of fittings having ISI marking.
2	R.C.C. Pipes Conforming to IS-458,1971	Indian Hume Pipe Co., Alcock Cement Products,Patel Spun (Surat)
3	G.I. Pipes Conforming to IS-1239,1968	Jindal, Tata, Bharat Steel Tube, Bombay, Zenith, G.S.T.Unik(C-class).
4	G.I. Fittings	" R " Mark, Unik.
5	Gun Metal Valves	Leader Engineering Works, Jalandhar, Crown / prince – Surat Bombay Metal Co Annapurna Metal Work, Calcutta 'Sant' brand, Jalandhar, L&K, Bombay metal & Alloy man. co. Bomaby, Premier, Aatco, Atlas, BR, BS, NN.
6	Brass fittings	Leader Engineering Works, Calcutta L & K Mathura, Crown / Prince -Surat Annapurna Metal Works, Calcutta, Perko, Kingstone Ark, Enclss Willians, Chilly, Aquva Plus,Nova,Kingstone,Driple, Ranutrol Hansa.
7	C.P. Fittings	Ego Metal Works, Ballabgarh,; GEM, New Delhi; Soma Calcutta; Bilmet, Bombay 'ESSCO', Delhi. Rajka Metal Works, Delhi Eng. Co. Metal Works, Calcutta Everite, NU-Lite Navbhart Shalimar Crown, Prince
8	W.C. Pan / Wash basin / Urinals / flushing cistern	CERA, Bell , Parry ware, Hindware , Neycer, Johnson
9	Flushing Cistern - Cast iron	Overhead - 'Nomos' 'ELCO' 'A-1'AUTOMATIC-EID Hindustan Sanitaryware, Calcutta, Nelson flush valve, SRIF(Agara), Parrys - Madras

10	E.W.C. Seats (solid)	E.I.D. Parry, Hindware, CERA, Neycer, Hindustan
11	Stainless Steel Sinks	Nirali, Diamond, Cobra, Jayna
12	Mirrors	Atul Glass Works , Haryana Sheet Glass Vallabh Glass Works, Modi Float glass, Asahi, Saint Gobin
13	Plumbing / Sanitary Fixtures / Accessories	Jaquar continental , CERA, Hindustan Sanitaryware / Parryco India. Hindware, Lauvet, Kohlar, Rak, Jaquar
14	C.I. Sluice valve, Check valves	Kirloskar, IVC, Burn, William Jacks, Indian Valve (IVC),
15	HDPE pipes	Duraline , Pennwalt Agru , Nocil, Jain, Supreme
16	Fibre reinforced R.C.C. Manhole Cover	Pratibha, CIDCO, approved brand
17	C.I. Manhole cover with frame	ISI approved make
18	P.V.C. Pipes & Fittings	Astral ,Supreme, Prince, Finolex
19	P.V.C. / H.D.P.E Water Tanks	Sintex or equivalent as approved by EIC.
20	Ball Cock	GPA Brand by Govardhan Das Jullunder, L & K Brand by L. K. Industries Mathura, Sant Brand by Sant Press Metal Works Jullundhar.
21	UPVC Pipes (Solvent Welded Joints)	Astral , Supreme, Prince, Jain.
22	C.P.V.C. Pipes & Fittings	Astral Supreme, Prince.
23	Water meter	Itron, Baylan or equivalent as approved by EIC.
24	Fire Hydrant Valve & Air Valve, Scour Valve	ISI approved make
25	Lift/Elevators	Otis, Kones, Schindler, Mitshubishi, Thyssun Krupp, Trio, Techno.
26	Electric Items	
	(i) Wires	R.R. Kable, Finolex, Polycab, Havells
	(ii) Switches and Accessories	Anchor, Allwyn, Pointer, Vinay, Alex, Promot
	(iii) Cable	Finolex, Torrent, Havells, KEI, RR Kable, CCI, UNIVERSAL, INCAB, GLOSTER, TROPODURE
	(iv) ARMOURED CABLES	Finolex, Torrent, Havells, KEI, RR Kable, CCI, UNIVERSAL, INCAB, GLOSTER, TROPODURE
	(v) MCB/ELCB/RCCB/ Distribution Board/Change over switch/SFU/SDF/ Motor Starter	Siemens/ L&T /Hager/Havells/ABB/Legrand/C&S/Schneider
	(vi) Pump Set	Kirlosker, Crompton, Lubi ,CRI
	(vii) Luminaries	Philips, GE ,Schredder
	(viii) RIGID pipes &	Finolex, Precision, Nihir, Polycab

	Accessories-for concealed wiring (ix) Liquid Level Controller (x) Earthing /Lightning Arrestor (xi) LED Aviation Light (xii) Street light pole (octagonal) (xiii) DWC pipe	GELCO, OCLEG C&S,BCH,Siemens E-Link, Ashlok, Rip, Etp Alpha-Lite, Avids Technovators Pvt Ltd. Bajaj,Transrail,Valmont Rex,Gemini,Duraline
27	Fire Fighting equipments	
	(i)GI Pipes/Fittings (ii) Cast iron butterfly valves (iii) Gun metal valves (iv) Hydrant valves & accessories (v) Hose Reel (vi) Pressure Guage (vii) Fire Pumps (viii) Fire Extinguishers (ix) Forged Fittings (x)Wrapping & Coating tape (xi) Epoxy Paint (xii) Hose pipes (xiii) Flow Switch (a) Anticorrosive Material	Jindal / Tata/Asian Audco/IVC/Kirloskar/Fouress Audco/IVC/Kirloskar/Fouress Newage/Aaag/Essel/Swati Newage / Minimax /Essel Fiebig / Pricol / Bells Control Kirloskar / Crompton / KSB/Lubi Safex / Minimax/Kenex VS/JK/True forge/DRP IWL/Coatek/Rustech Asian/ICI/Jenson & Nicholson Newage /CRC/Essel System Sensor,Potter,Honeywell,Rapid control I W L / Rustech/Euroclamp, Gripple,Chilly

IS Codes:

IS Code No.	Subject
GENERAL	
IS 4082	Stacking & storage of construction materials and components at site – Recommendations
IS 1200	Method of measurement of building and civil engineering work.(All Parts)
IS 1141	Seasoning of Timber – Code of practice
EARTH WORK	
IS 3674	Safety code for excavation work
IS 1498	Classification and identification of soils for general engineering purposes.
IS 1200 (Pt-1)	Method of measurement of earth work
IS 1200 (Pt-27)	Method of measurement of earth work (by Mechanical Appliances)
IS 4081	Safety code for Blasting and related drilling operation
IS 4988 (Part-IV)	Excavators
IS 6313 (Pt-II)	Anti-Termite measures in buildings (pre-constructional)

IS 6313 (Pt-III)	Anti-Termite measures in buildings for existing buildings
IS 6940	Methods of test for pesticides and their formulations
IS 8944	Chlorpyrifos emulsifiable concentrates
IS 8963	Chlorpyrifos – Technical specifications
IS 12138	Earth moving equipments
MORTARS	
IS 269	Specification for 33 grade ordinary Portland cement
IS 455	Specification for Portland slag cement
IS 650	Specification for standard sand for testing of cement
IS 1269	Specification for 53 grade ordinary Portland cement
IS 1542	Specification for sand for plaster
IS 2116	Specification for sand for masonry mortar
IS 2250	Code of practice for preparation and use of masonry Mortar
IS 3025	Method of sampling and test for water
IS 3406	Specification for masonry cement
IS 3812 (Part-I)	Specification for flyash for use as pozzolana in cement mortar and concrete
IS 3812 (Part-II)	Specification for flyash for use as admixture in cement mortar and concrete
IS 8041	Rapid hardening Portland cement
IS 8042	Specification for white cement
IS 8112	Specification for 43 grade ordinary Portland cement
IS 1298	Methods of test for determination of free lime in portland cement
IS 6452	High alumina cement for structural use
IS 1489	Portland Pazzolana Cement
CONCRETE WORK	
IS 383	Specification for coarse and fine aggregate from natural source for concrete
IS 303	Coarse and fine aggregates from natural sources for Concrete
IS 2430	Methods for sampling of aggregates for concrete
IS 2386	Method of test for aggregates for concrete
(a) Part-I : Particle size and shape	
(b) Part-II : Estimation of deleterious materials and organic impurities	
(c) Part-III : Specific gravity, density, voids absorption and bulking	
(d) Part-IV : Mechanical properties	

(e) Part-V : Soundness	
IS 2505	General requirements for concrete vibrators – immersion type
IS 2506	General requirements for concrete vibrators – screed board concrete vibrators
IS 2645	Specification for integral water proofing compounds for cement mortar and concrete
IS 761 (Part-I)	Code of practice for extreme weather concreting (Part-I) recommended practice for hot weather concreting
IS 7861 (Part-II)	Code of practice for extreme weather concreting (Part-II) Recommended
IS 9103	Specification for concrete admixtures
IS 460	Test sieves
IS 1607	Methods for dry sieving
IS 1834	Hot applied sealing compounds for jointing concrete
REINFORCED CEMENT CONCRETE WORK	
IS 1904	Structural safety of buildings, shallow foundation
IS 1893	Criteria for earthquake resistant design of structures
IS 432 (Part-I)	Specification for mild steel and medium tensile steel bars and hard drawn steel wire for concrete reinforcement part-I mild steel and medium tensile steel bars
IS 432 (part-II)	Specification for mild steel and medium tensile steel bars and hard drawn steel wire for concrete reinforcement part-II hard drawn steel wire
IS 456	Code of practice for plain and reinforced concrete
IS 516	Method of test for strength of concrete
IS 1199	Method of sampling and analysis of concrete
IS 1200 (Part-II)	Method of measurement of building and civil engineering work – concrete work
IS 1200 (Part-V)	Method of measurement of building and civil engineering work – concrete work (Part 5 – Form work)
IS 1566	Specification for hard drawn steel wire fabric for concrete requirement
IS 1599	Method of bend test
IS 1343	Code of practice for Prestressed Concrete
IS 1786	Specification for high strength deformed steel and wires for concrete reinforcement
IS 1791	Specification for batch type concrete mixes
IS 2502	Code of practice for bending and fixing of bars for concrete reinforcement
IS 2751	Recommended practice for welding of mild steel plain and deformed bars for reinforced construction

IS 4925	Batch plants specification for concrete batching and mixing plant
IS 4926	Ready – Mixed Concrete
IS 6523	Specification for precast reinforced concrete door, window frames
IS 10262	Recommended guidelines for concrete mix design
IS 13311 (Part-I)	Indian standard for non-destructive testing of concrete. Method of test for ultrasonic pulse velocity
IS 13311 (Part-II)	Indian standard for non-destructive testing of concrete. Method of testing by rebound hammer.
IS 3370	Concrete structures for storage of liquids
IS 1568	Wire gauge for general purposes
IS 1139	Hot rolled mild steel and medium tensile steel deformed bars for concrete reinforcements
IS 2502	Code of practice for bending and fixing of bars for concrete reinforcement
IS 2751	Code of practice for welding of mild steel bars used for reinforced concrete work
STEEL WORK	
IS 226	Structural steel
IS 2062	Steel for general structural purpose
IS 800	Code of practice for use of structural steel in general in steel construction
IS 806	Code of practice for use of steel Tubes in general building construction
S 816	Code of practice for use of metal arc welding for general construction in mild steel
IS 818	Code of practice for safety and healthy requirements in electric and gas welding and cutting operations
IS 822	Code of procedure for inspection of welds
IS 1038	Steel doors, windows and ventilators
IS 1081	Code of practice for fixing and glazing of metal (Steel and aluminium) doors, windows and ventilators
IS 1161	Steel tubes for structural purposes
IS 1200 (Pt. VIII)	Method of measurements of steel work and iron works
IS 1367	Technical supply conditions for threaded steel fasteners
IS 1821	Dimensions for clearances holes for bolts and screws
IS 2074	Ready mixed paint, air drying redoxide zinc chrome Priming
IS 4736	Hot – dip zinc coating on mild steel tubes
IS 4923	Hollow steel sections for structural use – specification
IS 6248	Metal rolling shutters and rolling grills
IS 7452	Specification for hot rolled steel sections for doors, windows and ventilators
BRICK WORK	
IS 712	Specification for building limes
IS 1077	Common burnt clay building bricks

IS 1200 (Part 3)	Method of measurements of brick works
IS 2212	Code of practice for brick work (1st Revision)
IS 3495	Method of test for burnt clay building bricks
IS 5454	Methods of sampling of clay building bricks
IS 13757	Specification of burnt clay fly ash bricks
IS 2691	Burnt clay facing bricks
MARBLE WORK	
IS 1122	Method of test for determination of true specific gravity of natural building stones
IS 1124	Method of test for determination of water absorption, apparent specific gravity and porosity of natural building stones
IS 1130	Marble (blocks, slabs and tiles)
IS 4101 (Part-I)	Code of practice for external facing and veneers: Stone Facing
IS 14223 (Part-I)	Polished Building Stones (Part-I) Granite
WOOD WORK AND P.V.C. WORK	
IS 204 (Part-I)	Specification for tower bolts (ferrous bolt)
IS 208	Specification for door handles
IS 287	Recommendations for maximum permissible moisture contents of timber used for different purpose
IS 303	Specification for plywood for general purposes
IS 401	Code of practice for preservation of timber
IS 453	Specification for double acting spring hinge
IS 710	Specifications for Marine Plywood
IS 1003 (Part-I)	Specification for timber paneled and glazed shutter Part-I (Door shutters)
IS 1003 (Part-II)	Specification for timber paneled and glazed shutter Part- II (Window and ventilator shutters)
IS 1200 Part-XIV	Method of measurement of building and civil engg. Work glazing
IS 1200 Part-XII	Wood work and joinery
IS 1328	Specification for veneered decorative plywood
IS 1341	Specification for steel butt hinges
IS 1659	Specification for block boards
IS 1823	Specification for floor door stopper
IS 1868	Specification for anodic coating on aluminium and its Alloy
IS 2046	-do- Decorative thermosetting synthetic resin bonded laminated sheet
IS 2095	Specification for gypsum plaster board
IS 2202 (Pt I)	Specification for wooden flush door shutter, solid core type (plywood face panels)
IS 2209	Specification for mortice lock (Vertical Type)
IS 2547	Specification for gypsum plaster

IS 3097	Specification for veneered particle board
IS 3564	Specification for door closer (hydraulically regulated)
IS 3847	Specification for mortice night latch
IS 5930	Specification for mortice latch
IS 7196	Specification for hold fast
IS 8756	Specification for mortice ball catch for use in wooden Almirah
IS 9308 (Part-II)	Specification for mechanically extracted coir fibres (Mattress coir fibres)
IS 12817	Specification for stainless steel butt hinges
IS 12823	Specification for wood products – Prelaminated particle Boards
IS 14900	Specifications for transparent float glass
IS 4021	Timber door, windows and ventilator frames.
IS 2191	Wooden flush door shutters (cellular and hollow core type)
FLOORING	
IS 1200 (Part-XI)	Method of measurement of Building and Civil Engineering work (Part 11) paving, floor finishes, dado and skirting
IS 1237-Edition 2.3	Specification for cement concrete flooring tiles
IS 1443	Code of practice for laying and finishing of cement concrete flooring tiles
IS 2114	Code of practice for laying in-situ terrazzo floor finish
IS 3622	Specification for sand stone (Slab & Tiles)
IS 4457	Acid and / or alkali Resistant tiles
IS 5318	Code of practice for laying of hard wood parquet and wood block floors
IS 5766	Code of practice for laying of burnt clay brick floor
IS 13630 (Part-1 to 15)	Methods of Testing for ceramic tiles
IS 13712	Specification for ceramic tiles, definition, classification characteristic and marking
IS 15622	Specification for pressed ceramic tile.
ROOFING	
IS 277	Galvanized steel sheets (Plain and corrugated)
IS 651	Glazed stoneware pipes and fittings
IS 1200 (Pt IX)	Method of measurements of building and civil engineering work : Part-9 Roof covering (including cladding)
IS 1200 (Pt X)	Method of measurements of building and civil engineering work : Part-10 ceiling and lining
IS 2095 (Pt-1)	Gypsum plaster boards (Pt. 1) plain Gypsum plaster Boards
IS 2935	Specification for flat transparent sheet glass
IS 459	Corrugated and semi corrugated asbestos cement sheet
FINISHING WORKS	
IS 1542	Sand for plaster
IS 1661	Code of practice for cement and cement-lime plaster finishes on walls

	and Ceilings
IS 1625	Code of practice for preparation and use of lime mortar in buildings
IS 2250	Code of practice for preparation and use of masonry Mortars
IS 712	Building limes
IS 1635	Code of practice for field slacking of lime and preparation of putty.
IS 427	Distemper, dry colour as required
IS 428	Distemper, oil emulsion, colour as required
IS 6278	Code of practice for white washing and colour washing
IS 106	Ready mixed paint, brushing, priming for enamels for use on wood.
IS 102	Ready mixed paint, brushing, red lead, non- setting, Priming
IS 123	Ready mixed paint, brushing, finishing, semi-gloss, for general purposes
IS 1477	Code of practice for painting of ferrous metals in Buildings
IS 2074	Ready mixed paint, red oxide-zinc chrome priming
IS 2339	Aluminium paint for general purposes in dual container
IS 2932	Enamel, synthetic, exterior, type 1
	(a) under coating,
	(b) finishing, colour as required
IS 137	Specification for ready mixed paint, brushing, matt or eggshell flat finishing interior to Indian Standard colour as required
IS 1131	Specification for enamel, interior
	(a) under coating
	(b) finishing.
IS 129	Specification for ready mixed paint, brushing, grey filler for enamel for use over primers
IS 533	Specification for gum spirit of turpentine (oil of turpentine)
IS 101	Methods of tests for ready, mixed paint, & enamels
IS 124	Specification for ready mixed paint, brushing finishing semi glossy for
(Part I) general purposes	
IS 2933	Enamel, Exterior
(a) Under Coating	
(b) Finishing	
IS 5410	Cement Paint
IS 5411	Plastic emulsion, Paint Part- I for interior use
IS 419	Specifications for putty for use in window frames
ROAD WORK	
IS 164	Ready mixed paint for road marking
IS 278	Specification for galvanized steel barbed wire for fencing
IS 1838 (Pt.1)	Specification for performed filters for expansion joint in concrete pavements and structures (non extruding and resilient type / bitumen

	impregnated fibre)
IS 73	Paving bitumen with bitumen felts
IS 73-1992	Specification for paving bitumen
IS 1203	Method of testing tar and bituminous material Determination of penetration
WATER SUPPLY, SANITARY INSTALLATIONS & DRAINAGE	
IS 771 (Pt.1)	Specification for glazed fire clay sanitary appliances : part 1: General requirements
IS 1703	Water fittings – copper alloy float valves (horizontal plunger type) – Specification
IS 1729	Cast iron / Ductile iron Drainage Pipes and pipe fittings for Over ground non-pressure pipe line Socket and Spigot Series
IS 1795	Specification for pillar taps for water supply purposes
IS 2326	Specification for Automatic Flushing Cisterns for Urinals (Other than plastic cisterns)
IS 2548 (Part-1)	Plastic seats and covers for water closets Part 1 : Thermo set seats and covers – Specifications
IS 2548 (Part-2)	Plastic seats and covers for water closets Part 2 : Thermoplastic seats and covers specification
S 2556	Vitreous sanitary appliances (vitreous chine) –Specifications
IS 2556 (Part-1)	Part-1: General requirements
IS 2556 (Part-2)	Paart-2 : Specific requirements of wash-down water Closets
IS 2556 (Part-4)	Part-4 : Specific requirements of wash basins
IS 2556 (Part-6)	Part-6 : Specific requirements of Urinals & Partitions Plates
IS 2556 (Part-7)	Part-7 : Specific requirements of accessories for sanitary Appliances
IS 2963	Specification for copper alloy waste fittings for wash basins and sinks
IS 3076	Specification for low density polyethylene pipes for potable water supplies
IS 4827	Specification for electroplated coating of nickel and chromium on copper and copper alloys
IS 4984	Specification for high density polyethylene pipes for potable water supplies
IS 4985	Unplasticised PVC pipes for potable water supply – Specifications
IS 7231	Plastic flushing cisterns for water closets and urinals – Specifications
IS 13983	Stainless steel sinks for domestic purposes – Specifications
IS 774	Specification for flushing cistern for water clo sets and Urinals
IS 775	Specification for cast iron brackets and supports for wash basins and sink.
IS 778	Specification for cast copper alloy gate and check valves for water works.
IS 651	Specification for salt glazed stoneware pipes and fittings.
IS 3597	Method of test for concrete pipes

IS 1239	Mild steel tubes and tubular
IS 1711	Self closing taps
IS 1726	Cast iron manhole covers and frames intended for use in drainage works
IS 1742	Code of practice for building drainage
IS 2065	Code of practice for water supply in buildings
IS 2470	Code of practice for design and construction of septic tank
IS 2693	Non-ferrous waste fittings for wash basins and sink
IS 4127	Code of practice for laying of glazed stoneware pipes
IS 4346	Washers for water taps for cold water services
IS 778	Gun metal gate, globe and check valves for water services
IS 7634	Laying and jointing for polythene pipes and PVC pipes (Part I to III)
IS 8008 Part I	Specification for injection Moulded HDPE fittings for potable to IV) water supplies
IS 3844	Code of practice for installation of internal fire hydrants in multi storey buildings
IS 780	Specification for sluice valves for water works purposes (50 to 300 mm size)
IS 781	Specification for cast copper alloy screw down bib taps and stop valves for water services
IS 782	Specification for caulking lead
IS 909	Underground fire hydrant, sluice valve type - Specification
IS 2692	Ferrules for water services - Specification
IS 15450	PE-AL-PE Pipes for hot and cold water supplies - Specifications
IS 15778	Chlorinated Polyvinyl Chloride (CPVC) pipes for potable hot and cold water distribution supplies - Specifications
IS 1230	Cast iron rain water pipes and fittings
IS 1626	Asbestos cement building pipes, gutters and fittings (Spigot and socket type)
IS 2527	Code of practice for fixing rainwater gutters and downpipes for roof drainage
IS 458	Pre-cast concrete pipes (with and without reinforcement)
IS 783	Code of practice for laying concrete pipes
IS 1728	Specification for Cast Iron Manhole Covers and Frames
IS 4127	Code of practice for Laying of Glazed Stone Ware Pipes
IS 12592	Pre-cast Concrete Manhole Covers and Frames-Specifications
IS 5382	Specification for rubber sealing rings for gas mains, water mains and sewers
IS 13592	Unplasticised polyvinyl chloride (UPVC) pipes for soil and Waste discharge system for inside and outside building
ALUMINIUM WORK	
IS 733	Wrought Aluminium Alloys, Bars, Rods and Sections (For General Engineering Purposes) - Specification
IS 737	Wrought Aluminium and aluminium alloy sheet
IS 1285	Wrought Aluminium and Aluminum Alloy, Extruded Round

	Tube and Hollow sections (for General Engineering Purposes) - Specification
IS 1868	Anodic coating on Aluminium and its alloy - Specification
IS 1948	Specification for Aluminium Doors, Windows and Ventilators
IS 5523	Method of testing anodic coating on aluminum and its alloys
IS 6012	Measurement of coating thickness by Eddy Current Method
IS 6315	Floor springs (Hydraulic regulated) for heavy doors - Specifications
IS 6477	Dimensions of extruded hollow section and tolerances
IS 14900	Transparent Float Glass - Specifications
WATR PROOFING TREATMENT	
IS 3370 (Part 1)	Code of practice for concrete structures for the storage of liquid : Part-1 General Requirements

SURAT MUNICIPAL CORPORATION

SLUM UPGRADATION DEPARTMENT



NAME OF WORK: Development of Integrated Group Housing Facility at T. P. Scheme No. 7 (Anjana), F.P. No. 191 Gandhinagar, Chimni Tekro , Juno Depo & Islampura & F.P. No 45 , Javaharnagar , Nehrunagar , Salimnagar , Gousiya Masjid, Anjana at Surat on Public Private Partnership (PPP) basis under Mukhya Mantri Gruh Yojana(Work No.1)

E- Tender

TENDER NOTICE NO : DC/SUC/12/2016-17

VOLUME-IV :
GENERAL CONDITIONS

SERIAL NO. OF THE WORK	:	1
DOWNLOADING OF TENDER DOCUMENTS STARTS FROM	:	Dt. 04/03/2017
DATE OF PRE-BID CONFERENCE	:	through e-mail before Dt. 15/03/2017.
LAST DATE OF DOWNLOAD OF TENDER DOCUMENTS FROM website smc.nprocure.com	:	Dt. 06/04/2017 upto 17.00 hrs
LAST DATE OF SUBMISSION OF ONLINE TENDER	:	Dt. 06/04/2017 upto 18.00 hrs
LAST DATE OF SUBMISSION OF TENDER FEES, EMD AND OTHER DOCUMENTS IN HARD COPY	:	During Dt. 07/04/2017 to 13/04/2017 upto upto 17.00 hrs
ESTIMATED AMOUNT	:	Rs. 216,00,00,000.00

**TENDER TO BE SUBMITTED TO:
THE CHIEF ACCOUNTANT,
SURAT MUNICIPAL CORPORATION, MUGLISARA
SURAT – 395 003.
BY R.P.A.D. / THROUGH POSTAL AUTHORITY / SPEED POST ONLY**

NAME OF WORK :- Development of Integrated Group Housing Facility at T. P. Scheme No. 7 (Anjana), F.P. No. 191 Gandhinagar, Chimni Tekro , Juno Depo & Islampura & F.P. No 45 , Javaharnagar , Nehrunagar , Salimnagar , Gousiya Masjid, Anjana at Surat on Public Private Partnership (PPP) basis under Mukhya Mantri Gruh Yojana (Work No.1)

e-TENDER (Online) NOTICE NO. : DC/SUC/12/2016-17

WORK NO. 1

Last date of submission of online Tender :

On or before Dt. 06/04/2017 up to 18.00 hrs

Last date of submission of All necessary documents mentioned in Technical bid (if any), Tender Fees, EMD and Other Documents in Hard Copy :

From Dt. 07/04/2017 to 13/04/2017 up to 17:00 hrs at the office of Chief Accountant, Surat Municipal Corporation, Muglisarai, Surat- 395 003.

Earnest Money : **Rs. 216,00,000.00** should be paid in the form of Demand Draft of any Nationalized/Scheduled Banks, Payable at Surat only.

OR

50% amount shall be in the form of Demand Draft and 50 % amount Shall be in the form of Bank guarantee of Nationalized/Scheduled Banks, Payable at Surat only.

Tender Fee : **Rs. 18,000.00** should be paid shall be in the form of Demand Draft of Nationalized/Scheduled Banks, Payable at Surat only.

Pre-Bid : Bidders shall have to post their queries on e-mail address slumupgradation@gmail.com before Dt. 15/03/2017 upto 17:00 hrs.

EXECUTIVE ENGINEER
SLUM UPGRADATION DEPARTMENT
SURAT MUNICIPAL CORPORATION

SIGNATURE OF THE CONTRACTOR.

DATE :

NAME AND ADDRESS :-

[TECHNICAL -BID]

NAME OF WORK : Development of Integrated Group Housing Facility at T. P. Scheme No. 7 (Anjana), F.P. No. 191 Gandhinagar, Chimni Tekro , Juno Depo & Islampura & F.P. No 45 , Javaharnagar , Nehrunagar , Salimnagar , Gousiya Masjid, Anjana at Surat on Public Private Partnership (PPP) basis under Mukhya Mantri Gruh Yojana(Work No.1)

Estimated Amount :- Rs. 216,00,00,000.00

E.M.D. :- Rs. 216,00,000.00

Tender Fee :- Rs. 18000.00

Receipt No. :- _____

Date :- _____

Issued to

CONTRACTOR _____

**Issuing Office : Executive Engineer, Slum Upgradation Department,
Old Rander Zone Office,Tadwadi, Rander Road,
Surat Municipal Corporation,
Surat.**

Signature & Date of the Issuing Officer :-

**Executive Engineer
Slum Upgradation Department
Surat Municipal Corporation.**

SIGNATURE OF THE CONTRACTOR.

DATE :

NAME AND ADDRESS :-

GENERAL CONDITIONS OF CONTRACT Definitions:

1. The Contract means the documents forming the tender and acceptance thereof and the formal agreement executed between the competent authority on behalf of the SMC and the Contractor/developer, together with the documents referred to therein including these conditions, the specifications, designs, drawings and instructions issued from time to time by the Engineer-in-Charge and all these documents taken together, shall be deemed to form one contract and shall be complementary to one another.
2. In the contract, the following expressions shall, unless the context otherwise requires, have the meanings, hereby respectively assigned to them:
 - i. The expression works or work shall, unless there be something either in the subject or context repugnant to such construction, be construed or taken to mean the works by or by virtue of the contract contracted to be executed whether temporary or permanent, and whether original, altered, substituted or additional.
 - ii. The Site shall mean the land/or other places on, into or through which work is to be executed under the contract or any adjacent land, path or street through which work, is to be executed under the contract or any adjacent land, path or street which may be allotted or used for the purpose of carrying out the contract.
 - iii. The Contractor/developer shall mean the individual, firm or company, whether incorporated or not, under taking the works and shall include the legal personal representative of such individual or the persons composing such firm or company, or the successors of such firm or company or the permitted assignees of such individual, firm or company.
 - iv. The Engineer-in-Charge means the Executive Engineer who shall supervise and be in charge of the work.
 - v. Accepting Authority shall mean the authority mentioned in schedule 'B'.
 - vi. Expected Risk are risk due to riots (other than those on account of contractor/developer's employees),war(whether declared or not) invasion, act of foreign enemies, hostilities, civil war, rebellion revolution, insurrection, military or usurped power any acts of Government, damages from aircraft, acts of god, such as earthquake, lightening and unprecedented flood, and other causes over which the contractor/developer has no control and accepted as such by the Accepting Authority or causes solely due to use or occupation by Government of the part of the works in respect of which a certificate of completion has been issued or a cause solely due to Government's faulty design of works.
 - vii. Market Rate shall be the rate as decided by the Engineer-in-Charge on the basis of the cost of materials and labour at the site where the work is to be executed plus the percentage mentioned in Schedule 'B' to cover, all overheads and profits.
 - viii. Schedule(s) referred to in these conditions shall mean the relevant schedule(s) annexed to the tender papers or the standard Schedule of Rates of the government mentioned in Schedule 'B' hereunder, with the amendments there to issue up to the date of receipt of the tender.
 - ix. Tendered value means the value of the entire work as stipulated in the letter of award.

- x. Date of commencement of work: the date of commencement of work shall be the date of start as specified in schedule 'B' or the first date of handing over of the site; whichever is later, in accordance with phasing if any, as indicated in tender document.
- xi. The Authority or SMC means the SuratMunicipal Corporation.
- xii. Commissioner means the Commissioner, Surat Municipal Corporation.
- xiii. The C. E. means the City Engineer of Surat Municipal Corporation.

3. Scope and Performance:

Where the context so requires, words imparting the singular only also include the plural and vice versa. Any reference to masculine gender shall whenever required include feminine gender advice versa.

- 4. Heading and Marginal notes to these General Conditions of Contract shall not be deemed to form part thereof or taken into consideration in the interpretation or construction thereof or of the contract.
- 5. The contractor/developer shall be furnished, free of cost one certified copy of the contract documents except standard specifications, Schedule of Rates and such other printed and published documents, together with all drawings as may be forming part of the tender papers. None of these documents shall be used for any purpose other than that of this contract.
- 6. Sufficiency of Tender The Contractor/developer shall be deemed to have satisfied himself before tendering as to the correctness sand sufficiency of his tender for the works and of the rates and prices quoted in the Schedule of Quantities, which rates and prices shall, except as otherwise provided, cover all his obligations under the Contract and all matters for the proper completion and maintenance of the works.
- 7. Discrepancies and Adjustment of Errors : The several documents forming the Contract are to be taken as mutually explanatory of one another, detailed drawings being followed in preference to small scale drawing and figured dimensions in preference to scale and special conditions in preference to General Conditions.
 - 7.1. In the case of discrepancy between the Schedule of Quantities, Specifications, and/or the Drawings, the following order of preference shall be observed:
 - i. Description of schedule of quantities.
 - ii. Particular specification and Special Condition, if any.
 - iii. Drawing.
 - iv. Detailed Specifications.
 - v. Indian Standard Specifications of B.I.S
 - 7.2. If there are varying or conflicting provisions made in any one document forming part of the contract, the Accepting Authority shall be the deciding authority with regard to the intention

- 7.3. Any error in description, quantity or rate in Schedule of Quantities or any omission there from part of the works comprised therein according to drawing and specifications or from any of his obligations under the contract shall not vitiate the Contract or release the Contractor/developer from the execution of the whole or any

8. Signing of Contract:

The successful tenderer/contractor/developer, on acceptance of his tender by the Accepting Authority, shall, within 7 days from the stipulated date of start of work sign the contract consisting of:

- i) The letter inviting tender, all the documents including drawing, if any, forms the tender as issued at the time of invitation of tender and acceptance thereof together with any correspondence leading thereto.
 - ii) Standard tender document as mentioned in Schedule 'B' consisting of:
 - a) Various Standard clauses with corrections up to the date stipulated in Schedule 'B' along with annexure thereto.
 - b) Safety Code
 - c) Model Rules for the protection of health, sanitary arrangements for Contractor/developers employed by SMC or its contractor/developers.
 - d) Contractor/developers labour regulations.
 - e) List of Acts and omissions for which fines can be imposed.
 - iii) No payment for work done will be made unless contract is signed by the contractor/developer.
9. The contractor/developer (s) is/are to provide everything of every sort and kind which may be necessary and requisite for the due and proper execution of the several works included in the contract. Whether original or altered according to the true intent and meaning of the drawings and specifications taken together, which are to be signed by the Executive Engineer and the Contractor/developer(s), whether the same may or may not particularly be described in the specifications or shown on the drawings, provided that the same are reasonably to be inferred in reform and incise of any discrepancy between the drawings and the specifications the Executive Engineers to decide which shall be followed.
10. The contractor/developer(s) is / are to set out the whole of the works in conjunction with an officer to be deputed by the Engineer-in-charge, and during the progress of the works to amend on the requisition of the Engineer-in-charge, any errors, which may arise therein and provide all the necessary labour and materials for doing so. The contractor/developer(s) is / are to provide all plants, labour and materials which may be necessary and requisite for the works. All materials and workmanship are to be the best of their respective kinds. The contractor/developer(s) is/are to leave the works in all respects clean and perfect after the completion thereof.
11. The copies of all architectural drawing and structural drawings duly approved by as suggested by Engineer-in-Charge as third party quality assurance and the contractor/developer shall at all times during the usual working hours and at all other times at which reasonable notice of the intention of the Executive Engineer or his Subordinate to visit the works shall be given to the contractor/developer(s), either himself / themselves be

present to receive orders and instructions or have a responsible agent duly accredited in writing present for that purpose. Orders given to the contractor/developer(s) agent shall be considered to have the same force as if they had been given to the contractor/developer(s) himself/ themselves. The Executive Engineer may require the contractor/developer(s) to dismiss any person in the contractor/developer(s) employment upon the works who may be incompetent or misconduct himself, and the contractor/developer(s) is/are forthwith to comply with such requirement's SMC etc. and specifications contained in the tender documents shall be kept by the contractor/developer on the site of the work.

12. All work under or in course of execution or executed in pursuance of the contract shall at all times be open to the inspection and supervision of the City Engineer, Executive Engineer, AE / Supervisor/TA of SMC, or by the officer of Vigilance of the authority and Executive Engineer, (Elect.) & their subordinate including any government or reputed private institution appointed by Engineer-in-Charge as third party quality assurance and the contractor/developer shall at all times during the usual working hours and at all other times at which reasonable notice of the intention of the City Engineer or his Subordinate to visit the works shall be given to the contractor/developer(s), either himself / themselves be present to receive orders and instructions or have a responsible agent duly accredited in writing present for that purpose. Orders given to the contractor/developer(s) agent shall be considered to have the same force as if they had been given to the contractor/developer(s) himself/ themselves. The Executive Engineer may require the contractor/developer(s) to dismiss any person in the contractor/developer(s) employment upon the works who may be incompetent or misconduct himself, and the contractor/developer(s) is/are forthwith to comply with such requirements.
13. The contractor/developer(s) is/are not to vary or deviate from the approved drawings, specifications or instructions to execute any extra work of any kind whatsoever unless the authority of the City Engineer to be sufficiently shown by an order in writing or by any plan or drawing expressly given and signed by him as an extra, or variation, or by any subsequent written approval signed by him. If compliance with the City Engineer's aforesaid order, plan or drawing, or approval involves extra work, and / or expense beyond that involved in the execution of the contract works, then unless the same were issued in consequence of some breach of this contract on the part of the contractor/developer(s), the later shall be paid the price of the said work (to be valued as hereinafter provided) and / or the expense aforesaid.
14. The contractor/developer (s) shall give not less than five working days' notice in writing to the Executive Engineer before covering up, or otherwise placing, beyond the reach of measurement any work, in order that additions, omissions and alternations not covered by the original contract may be measured and correct dimensions thereof be taken before the same are so covered up or placed beyond the reach of measurement any work without the consent in writing of the Executive Engineer, and if any work shall be covered up or placed beyond the reach of measurement without such notice been given or consent obtained, the same shall be uncovered at the contractor/developer (s) expenses, or in default thereof, no payment or allowance shall be made for such work or materials with which the same was executed.

15. All work and materials brought by the contractor/developer(s) or by his/their order(s) for the purpose of forming part of the works are to be considered to be the property of the SMC and the same are not to be removed or taken away by the contractor/developer(s) or any other person without the consent in writing of the Executive Engineer, but the SMC is not to be in anyway answerable for any loss or damage that may happen to, or in respect of any such work or materials either by the same being lost or stolen or injured by weather, mishap, or otherwise.
16. The Engineer-in-Charge shall have full powers to require the removal from the premises of all materials which in his opinion are not in accordance with the Specifications and in case of default, the Engineer-in-Charge shall be at liberty to employ at the expense of the Contractor/developer, other persons to remove the same without being answerable or accountable for any loss or damage that may happen or arise to such materials. The Engineer-in-Charge shall also have full power to require other proper material to be substituted thereof and in case of default the Engineer-in-Charge may cause the same to be supplied and all costs which may arise due to such removal and substitution shall be borne by the Contractor/developer.
17. Any defects (including structural defects), or other faults which may appear within 7(seven) year from the recorded date of completion of the building arising out of defective or improper materials or workmanship are upon the direction of the Additional City Engineer to be amended and made good by the contractor/developer(s) at his / their own cost, and in case of a default, the Executive Engineer may recover from the contractor/developer(s) the cost of making good the works(of which the certificate of the Executive Engineer shall be final) from any sum that may be then, or at any time thereafter may become, due to the contractor/developer(s) by SMC under the contractor/developer otherwise, or from his/their security deposit or proceeds thereof, of a sufficient portion thereof.
18. From the commencement of the work to the completion of the same they are to be under the contractor/developer(s) charge. The contractor/developer(s) is / are to be held responsible for and to make good all injuries, damages, and repairs occasioned or rendered necessary to the same by fire, rains, storms, traffic, flood or other cause and to hold SMC harmless from any claims for injuries to persons, or to structural damage to property, happening from any neglect, default, want of proper care or misconduct on the part of the contractor/developer(s) or of anyone in his/their employment during the execution of the works.
19. The Executive Engineer to has full powers to send workmen upon the premises to execute fittings / fixtures and other works not included in the contract for whose operation the contractor/developer(s) is /are to afford reasonable facility during ordinary working hours, provided that such operations shall be carried out in such a manner so as not to impede the progress of the work included in the contract but the contractor/developer(s) is/are not to be held responsible for any damage which may happen to be occasioned by any such fittings / fixtures or other works.

SPECIAL CONDITIONS OF CONTRACT

1. Condition for Cement:

- 1.1. Cement required for the work shall be procured by the contractor/developer. The contractor/developer shall procure, only Ordinary Portland Cement (conforming to IS: 12269/1987). This procurement shall be from reputed manufacturers of cement having a production capacity of one million tons per annum or more as approved by Ministry of Industry, Government of India and holding license to use IS certification make for their product whose name shall be got approved from Engineer-in-charge. Supply of cement shall be taken in 50 Kg. Bags bearing manufacturer's name or his registered trademark, if any and grade and type of cement as well as IS marking.
- 1.2. The account of daily receipt and issue of cement shall be maintained in a register in the prescribed Performa and signed daily by the contractor/developer or his authorized agent in token of its correctness.
- 1.3. Samples of cement arranged by the contractor/developer shall be taken by the Engineer-in-charge and got tested in accordance with provisions of relevant BIS Code. In case test results indicate that the cement arranged by the contractor/developer does not conform to the relevant BIS codes the same shall stand rejected and shall be removed from the site by the contractor/developer at his own cost within a week's time of written order from the Engineer-in-charge.
- 1.4. The contractor/developer shall supply free of charge the cement required for testing. The cost of testing charges shall be borne by the contractor/developer.
- 1.5. The actual issue and consumption of cement on work shall be regulated and proper accounts maintained as provided in clause 40.
- 1.6. For non-scheduled items, the decision of the Executive Engineer regarding theoretical quantity of cement which should have been actually used shall be final and binding on the contractor/developer.
- 1.7. Cement brought to site and remaining unused after completion of work shall not be removed from site without written permission of the Engineer-in-charge.
- 1.8. In case quantity of cement used is less than quantity ascertained under clause 40(after allowing variation on the minus side as per clause) the quantity of less cement used shall be recovered at prevailing market rate at the time of execution+ 15% contractor/developer's profit.

2. Conditions of Steel:

- 2.1. The contractor/developer shall procure steel reinforcement of Thermo Mechanically Treated Bars Fe-415 conforming to IS-1786:1985(reaffirmed 2004). The contractor/developer shall have to submit documentary proof to the satisfaction of the Engineer-in-charge of having procured the steel reinforcement. The contractor/developer shall have to obtain and furnish test certificates to the Engineer-in-charge and get tested in accordance with provision of relevant specifications. In case, test results indicate that the steel arranged by the contractor/developer does not confirm to the specifications, the same

shall stand rejected and shall be removed from the site of work by the contractor/developer at his own cost within 7 days of written order from the Engineer-in-charge to do so.

- 2.2. The steel reinforcement bars shall be brought to the site in bulk supply of 10 tons or more directed by the Engineer-in-charge.
- 2.3. The steel reinforcement shall be stored by the contractor/developer at site of work in such a way as to prevent distortion and corrosion and nothing extra shall be paid on this account. Bars of different sizes and lengths shall be stored separately to facilitate easy counting and checking.
- 2.4. For checking nominal mass tensile strength, bend test, rebound test etc. specimen of sufficient length shall be cut from each size of the bar at random at frequency not less than that specified below:-

Size of Bar	For consignment below 100 tons	For consignment above 100 Tons
Under 10mm dia. Bars	One sample for each 25 tons or part thereof	For consignment above 100 Tons
10mm to 16mm dia. Bars	One sample for each 35 tons or part thereof	One sample for each 40 tons or part thereof
Over 16mm dia. Bars	One sample for each 45 tons or part thereof	One sample for each 50 tons or part thereof

The contractor/developer shall supply free of charge the steel required for testing. The cost of tests shall be borne by the contractor/developer.

- 2.5. Steel brought to site and steel remaining unused shall not be removed from site without the written permission of Engineer-in-charge.
- 2.6. Every care should be taken to avoid mixing different types of grades of bars in the same structural members as main reinforcement to satisfy relevant clause of IS: 456. In case of buildings wherever the situation necessitates the changeover shall be made only from anyone level onwards. In case of foundation, all foundation elements (footing and grade beams) shall have the same kind of steel. In case of columns all structural elements up to the level of change where the changeover is taking place should have the same kind of steel as those in columns,
- 2.7. The reinforcing steel brought to site of work, shall be stored on brick / timber platform of 30/40cm. height. Nothing extra shall be paid on this account.

3. Condition for Water:

- 3.1. The contractor/developer shall make his own arrangement for providing water for construction and drinking purpose. Contactor shall get the water tested from any approved laboratory of SMC as per direction of Engineer-in-Charge at regular interval all expenses towards collection of samples, packing, transportation and testing charges etc. shall be borne by the contractor/developers.
- 3.2. The contractor/developer shall arrange at his own cost and nothing extra shall be paid to the contractor/developer on this account. The water shall be got tested at SMC laboratory.
- 3.3. In the event of any difference of opinion among site representatives in carrying out the item of work in accordance with the agreement the Engineer-in-charge shall decide the

issue and his decision shall be final and binding on the contractor and the contractor shall be bound to carry out the instruction to complete work in time. At no point of time the contractor/developer shall stop execution of the work on any ground whatsoever.

4. Condition for Bitumen:

- 4.1. The contractor undertakes to make arrangement for the supervision of the work by the firm supplying the tar or bitumen used.
- 4.2. The contractor/developer shall collect the total quantity of tar or bitumen require for the work as per standard formula before the process of painting is started and shall hypothecate it to the Engineer-in-charge. If any bitumen or tar remains unused on completion of work on accounts of the work less use of material in execution lesser for reason other than authorized changes of specification and abandonment of portion of work, corresponding deduction equivalent to the cost or unused material determined by the Engineer-in-charge shall be made and materials returned to the contractor/developer. Although the materials are hypothecated to SMC the contractor undertake the responsibility for the proper watch, safe custody and protection against all risk. The materials shall not be removed from site of work without the consent of the Engineer-in-charge in writing.
- 4.3. The contractor/developer shall be responsible for rectifying defects noticed within ten years from the date of completion of work and portion of the security deposit relating to asphaltic work shall be refunded after the expiry of this period.

5. Submission of structural drawings/design:

The structural; drawing in order of priority and chronological order as mentioned below should be submitted for approval of the Engineer-in-charge.

Sr. No.	Description	Duration
1	All architectural drawings as per plot	Within 1 weeks from the date of issuing of work order
2	Foundation drawings (Structural)	Within 2 weeks from the date of submission of soil investigation report.
3	Services drawings such as water supply sewer line SW drains including UGR, water Gallery PUMP Houses, GPCB, GFO & St. PCB etc.	2 months from the date stipulated date of start

Structural drawings will be submitted by the agency as per schedule given above, which will be got approved from the institutions stated in the tender documents. It will be submitted through Executive Engineer. It has to be ensured by the agency that the drawings are got approved from the institution referred above with in months' time from the date of its submission. All service plans should be got approved from the concern Authority/department within 6 months from the stipulated date of start. It is entirely the responsibility of the contractor/developer to get the above designs approved and finalized within aforesaid period. Any delay on this account will attract compensation as per clause 2.

The contractor/developer(s) shall supply 5 copies of / laminated approved structural drawings/architectural drawings to the Engineer-in-charge for the use of the SMC

after having approved from the competent authority within 7 days from the receipt of approval. In addition to above sets of drawings, contractor/developer shall keep necessary sets of drawings required at site for its execution as directed by the Engineer-in-charge.

6. Handing over of Flats/Houses:

Three months before the likely date of completion of flats in all respects, contractor/developer shall intimate to the Engineer-in-charge the following.

- a. The contractor/developers/agency shall lay the services as per approved plan by concern department. On completion of services the contractor/developer /agency will submit the required number of completion plan to various authorities/ beneficiaries for handing over. The SMC also reserves the right to withhold the amount which is likely to be payable to these agencies as deficiency charges. The decision of the Engineer-in-charge in this regard shall be final and binding on the contractor/developer(s)/agency(s).
- b. The contractor/developer shall have to give possession of DUs completed in all respect to the beneficiaries as and when directed by SMC after completion of the allotment procedure as per Govt. guidelines.

7. Testing of materials:

When required by the Engineer-in-charge the contractor/developer(s) shall supply for the purpose of testing samples of all materials proposed to be used in the works. Samples submitted either to govern bulk supplies or required for testing before use shall be in suitable packages to contain them and shall be provided free of charge by the contractor/developer. The cost of testing shall be borne by the contractor/developer even if the result of the sample confirm or do not confirm to the relevant BIS code and specifications.

- a) All expenditure required to be incurred for taking the samples conveyance, packing shall be borne by the contactor himself.
- b) The failed material shall be removed from the site by the contractor/developer at his own cost within week time of written order of the Engineer-in-charge.

8. Setting of site Laboratories:

The contractor/developer shall install testing equipment as per Annexure III at site. The contractor/developer shall ensure and certify the calibration of the equipment so installed and shall maintain the same in working order throughout the period of construction. The contractor/developer shall also provide necessary trained staff for carrying out such tests for using such equipment. The tests shall be carried out under the supervision of the Engineer-in-charge. 70% of the total tests to be done is to be carried out on site laboratory if the facilities are available as per tender terms and conditions, remaining 15% tests is to be carried out at govt./ Semi Govt. laboratory and 15% tests is to be carried out at Govt. recognised laboratory.

9. Instructions for Composite Contract:

It will be obligatory on the part of the tenderer to sign the tender documents for all the components, (The schedule of quantities, conditions and special conditions etc.)

10.

- a. The contractor/developer shall construct/provide site office at the project site as per the requirement, with toilet facility & meeting room with all furniture, including computer, printer, fax, internet etc. Nothing extra for this facility shall be payable.
 - b. The contractor/developer will provide air-conditioned office space with required furniture for use of site office.
- 11.** In case of breakage of any existing service lines, it shall be immediately attended by the contractor/developer failing which SMC has full liberty to get work done at the cost and risk of the contractor/developer over and above repairing charges / penalty as decided by the Engineer in charge shall be imposed and deducted from Bill of the contractor/developer.
- 12.** For Road diversion permission SMC will assist the contractor/developer in getting the same from the concerned authorities however precautions related to safety, barricading, signboards etc. will be responsibility of the contractor/developer.

CLAUSES OF CONTRACT

CLAUSE 1: Security Deposit

- i. The Contractor/developer shall submit an security deposit in form of irrevocable Bank Guarantee of 5% (five percent) of the tendered amount in addition to other deposits mentioned elsewhere in the contract for his proper performance of the contract agreement, (not withstanding and/ or without prejudice to any other provisions in the contract) within 15 days period from the date of issue of letter of acceptance. This guarantee shall be in the form of Guarantee Bonds of any Nationalized Bank payable at surat in accordance with the form annexed hereto.
- ii. The Security Deposit shall be initially valid up to the stipulated date of completion plus 60 days beyond that. In case the time for completion of work gets enlarged, the contractor/developer shall get the validity of bank Guarantee extended to cover such enlarged time for completion of work. After recording of the completion certificate for the work by the competent authority, the security deposit shall be returned to the contractor/developer, without any interest.
- iii. The Engineer-in-Charge shall not make a claim under the Security Deposit except for amounts to which the SMC is entitled under the contract (not withstanding and/or without prejudice to another provisions in the contract agreement) in the event of:
 - a) Failure by the contractor/developer to extend the validity of the S D bank Guarantee as described hereinabove, in which event the Engineer-in-Charge may claim the full amount of the Performance Guarantee.
 - b) Failure by the contractor/developer to pay SMC any amount due, either as agreed by the contractor/developer or determined under any of the Clauses/Conditions of the agreement, within 30 days of the service of notice to this effect by Engineer-in-Charge.
 - c) In the event of the contract being determined or rescinded under provision of any of the Clause/Condition of the agreement, the performance guarantee shall stand forfeited in full and shall be absolutely at the disposal of the SMC.
 - d) A letter of intent shall be issued in the first instance informing the successful tender by the competent Authority to accept his tender and the award letter shall be issued only after the Security Deposit in any of the prescribed from is received. In case of failure by the

Contractor/developer to furnish the Security Deposit within the specified period, SMC shall without prejudice to any other right or remedy available in law, be at liberty to forfeit the Earnest Money absolutely.

e) Performance Guarantee/Bond

The performance guarantee of 5% of the value of actual work done shall be delivered to the SMC at the time of completion of work under contract or as instructed by the Engineer -in-charge. The contractor/developer may at his option convert security deposit in to performance guarantee.

CLAUSE 1A: Recovery of Performance Guarantee/ Bond 50% of the performance guarantees (2.5% value of work done) shall become refundable after 3 years of the final completion certificate is issued. Another 1.5% of performance guarantee will be released after another 2 years (i.e. after 5 years of completion) remaining 1.0 % of bank guarantee will be released after another 2 years i.e. Total 7 years of defect liability period, provided that there is no defect detected within the said period.

CLAUSE 2:

Compensation for Delay

If the contractor/developer fails to maintain the required progress in terms of clause 5 or to complete the work and clear the site on or before the contract or extended date of completion, he shall, without prejudice to any other right or remedy available under the law to the SMC on account of such breach, pay as agreed compensation the amount calculated at the rates stipulated below as the Authority specified (whose decision in writing shall be final & binding) may decide on the amount of tendered value of the work for every completed day/month (as applicable) that the progress remains below that specified in clause 5 or that the work remains incomplete. This will also apply to items or group of items for which a separate period of completion has been specified. (After completion of original/extended time limit 0.1% per week of the total project value shall be charged as liquidated damages (penalty) or the amount as decided by Municipal Commissioner) Provided always that the total amount of compensation for delay to be paid under this condition shall not exceed 10% of the Tendered Value of work or of the tendered Value of the item or group of items of work for which a separate period of completion is originally given. The amount of compensation may be adjusted or set-off against any sum payable to the contractor/developer under this or any other contract with the SMC. In case, the contractor/developer does not achieve a particular milestone mentioned in table of milestones, or the rescheduled milestone(s) in terms of clause 5.4, the amount shown against the milestone shall be withheld, to be adjusted against the compensation levied at the final grant of Extension of Time. With holding of amount on failure to achieve a milestone, shall be automatic without any notice to the contractor/developer. However, if the contractor/developer catches up with the progress of work on the subsequent milestone(s) the withheld amount shall be released. In case the contractor/developer fails to make up for the delay in subsequent milestone(s), amount mentioned against each milestone missed subsequently also shall be withheld. However, no interest, whatsoever, shall be payable on such withheld amount.

CLAUSE 3: When contract can be terminated: Subject to other provisions contained in this clause, the Engineer-in-charge may, without prejudice to his any other rights or remedy against the contractor/developer in respect of any delay, inferior workmanship, any claims for damages and/ or any other provisions of this contract or otherwise, and whether the date of completion has or has not elapsed, by notice in writing absolutely terminated the contract in any of the following cases::

i. If the contractor/developer having been given by the Engineer-in-charge a notice in writing to rectify, reconstruct or replace any defective work or that the work is being performed in an

inefficient or otherwise improper or un-workman like manner shall omit to comply with the requirement of such notice for a period of seven days thereafter.

ii. If the contractor/developer has, without reasonable cause, suspended that progress of the work or has failed to proceed with the work with due diligence so that in the opinion of the Engineer-in charge (which shall be final and binding) he will be unable to secure completion of the work by the date for completion and continues to do so after a notice in writing of seven days from the Engineer-in-charge.

iii. If the contractor/developer fails to complete the work within the stipulated date or items of work with individual date of completion, if any stipulated, on or before such date (s) of completion and does not complete them within the period specified in a notice given in writing in that behalf by the Engineer-in-charge.

iv. If the contractor/developer persistently neglects to carry out his obligations under the contract and / or commits default in complying with any of the terms and conditions of the contract and does not remedy it or take effective steps to remedy it within 7 days after a notice in writing is given to him on behalf of SMC by the Engineer-in-charge.

v. If the contractor/developer shall offer or give or agree to give to any person in SMC service or to any other person on his behalf any gift or consideration of any kind as an inducement or reward for doing or for bearing to do or for having done or forborne to do any act in relation to the obtaining or execution of this or any other contract for SMC.

vi. If the contractor/developer shall enter into a contract with SMC in connection with which commission has been paid or agreed to be paid by him or to his knowledge, unless the particulars of any such commission and the terms of payment thereof have been previously disclosed in writing to the Engineer-in-charge.

vii. If the contractor/developer shall obtain a contract with SMC as a result of wrong tendering or other non-bonafide methods of competitive tendering.

viii. If the contractor/developer being an individual or if a firm, any partner thereof shall at any time be adjusted insolvent or have a receiving order or order for administration of his estate made adjust him or shall take any proceedings for liquidation or composition (other than a voluntary liquidation for the purpose of amalgamation or reconstruction) under any Insolvency Act for the time being in force or make any conveyance or assignment of his effects or composition or arrangement for the benefit of his creditors or purport so to do, or if any application be made under any Insolvency Act for the time being in force for the sequestration of his estate or if a trust deed be executed by him for benefit of his creditors.

ix. If the contractor/developer being a company shall pass a resolution or the court shall make an order that the company shall be wound up or if a receiver or a manager on behalf of a creditor shall be appointed or if circumstances shall arise which entitle the court or the creditor to appoint a receiver or a manager or which entitle the court to make a winding up order.

x. If the contractor/developer shall suffer an execution being levied on his goods and allow it to be continued for a period of 21 days.

xi. If the contractor/developer assigns, transfers, sublets (engagement of labour on a piece work basis or of labour with materials not to be incorporated in the work, shall not be deemed to the subletting) or otherwise parts with or attempts to assign, transfer, sublet or otherwise parts with the entire works or any portion thereof without the prior written approval of the Engineer-in-charge.

When the contractor/developer has made himself liable under any of the case aforesaid, the engineer in charge on behalf of SMC shall have powers.

a. To determine the contractor/developer as aforesaid (of which termination notice in writing to the contractor/developer under the hand of the Engineer - in charge shall be conclusive evidence) Upon such determination, the Earnest Money deposit, Security Deposit already recovered and performance Guarantee under the contract shall be liable to be forfeited and shall be absolutely at the disposal of the SMC.

b. After giving notice to the contractor/developer to measure up the work of the contractor/developer and to take such whole, or the balance or part thereof, as shall be un-executed out of his hands and to give it to another contractor/developer to complete the work. The contractor/developer whose contract is determine as above, shall not be allowed to participate in the tendering process for the balance work. In the event of above courses being adopted by the Engineer-in-charge, the contractor/developer shall have no claim to compensation for any loss sustained by him by reasons of his having purchases or procured any materials or entered into any engagements or made any advances on account or with a view to the execution of the work or the performance of the contract. And in case action is taken under any of the provision aforesaid, the contractor/developer shall not be entitled to recover or be paid any sum for any work thereof or actually performed under this contract unless and until the Engineer-in-charge has certified in writing the performance of such work and the value payable in respect thereof and he shall only be entitled to be paid the value so certified.

CLAUSE 3A: In case, the work cannot be started due to reasons not within the control of the contractor/developer within 1/8th of the stipulated time for completion of work, either party may close the contract. In such eventuality, the Earnest Money Deposit and the performance Guarantee of the contractor/developer shall be refunded, but no payment on account of interest, loss of profit or damages etc. shall be payable at all.

CLAUSE 4:

Contractor/developer liable to pay compensation even if action not taken under clause-3. In any case in which any of the powers conferred upon the Engineer-in-charge by clause-3 thereof, shall have become exercisable and the same are not exercised, the non-exercise thereof shall not constitute a waiver of any of the conditions hereof and such powers shall notwithstanding be exercisable in the event of any future case of default by the contractor/developer and the liability of the contractor/developer for compensation shall remain unaffected. In the event of the Engineer-in-charge putting in force all or any of the powers vested in him under the preceding clause he may, if he so desires after giving a notice in writing to the contractor/developer, take possession of (or at the sole discretion of the Engineer- in-charge which shall be final and binding on the contractor/developer) use as on hire (the amount of the hire money being also in the final determination of the Engineer-in charge)all or any tools, plant, materials and stores, in or upon the works, or the site thereof belongings to the contractor/developer, or procured by the contractor/developer and intended to be used for the execution of the work/ or any part thereof, paying or allowing for the same in account at the contract rates, or, in the case of these not being applicable, at current market rates to be certified by the Engineer-in-charge, whose certificate thereof shall be final, and binding on the contractor/developer, clerk of the works, foreman or

other authorized agent to remove such tools, plant, materials, or stores from the premises(within a time to be specified in such notice) in the event of the contractor/developer failing to comply with any such requisition, the Engineer-in-charge may remove them at the contractor/developer's expense or sell them by auction or private sale on account of the contractor/developer and his risk in all respects and the certificate of the Engineer-in-charge as to the expenses of any such removal and the amount of the proceeds and expenses of any such sale shall be final and conclusive against the contractor/developer.

CLAUSE 5:

Time and Extension for Delay:

The time allowed for execution of the works as specified or the extended time in accordance with these conditions shall be the essence of the contract. The execution of the works shall commence from such time period as mentioned in letter of acceptance or from the date of handing over of the site whichever is later. If the contractor/developer commits default in commencing the execution of the work as aforesaid, SMC shall without prejudice to any other right or remedy available in law, be at liberty to forfeit the earnest money & performance guarantee absolutely.

1. As soon as possible after the contract is concluded the contractor/developer shall submit a Time and Progress Chart for each milestone and get it approved by the Engineer-in-charge. The chart shall be prepared in direct relation to the time stated in the contract documents for completion of items of the works. It shall indicate the forecast of the dates of commencement and completion of various trades of sections of the work and may be amended as necessary by agreement between the Engineer-in-charge and the contractor/developer within the limitations of time imposed in the contract documents, and further to ensure good progress during the execution of the work, the contractor/developer shall in all cases in which the time allowed for any work, exceed one month (save for special jobs for which a separate program has been agreed upon)complete the work as per milestones.
2. If the work(s) be delayed by:
 - i. Force Measure, or
 - ii. Abnormally bad weather, or
 - iii. Serious loss or damage by fire, or
 - iv. Civil commotion, local commotion of workmen, strike or lockout, affecting any of the trades employed on the work, or
 - v. Delay on the part of other contractor/developers or tradesmen engaged by Engineer-in-charge in Executing work not forming part of the contractor/developer, or
 - vi. Non availability of stores, which are the responsibility of SMC to supply or
 - vii. Non availability or break down of tools and plant to be supplied or supplied by SMC, or
 - viii. Any other cause, which in the absolute discretion of the authority is beyond the contractor/developer's control.

Then upon the happening of any such event causing delay, the contractor/developer shall immediately, give notice thereof in writing to the Authority but shall nevertheless use constantly his best endeavours to prevent or make good the delay and shall do all that may be reasonably required to the satisfaction of the Engineer-in-charge to proceed with the works.

3. Request for rescheduling of Milestones and extension of time, to be eligible for consideration, shall be made by the contractor/developer in writing within fourteen days of the happening of the event causing delay on the prescribed form to the Authority. The contractor/developer may also, if practice able, indicate in such a request the period for which extension is desired.
4. In any such case the authority may give a fair and reasonable extension of time and reschedule the milestones for completion of work. Such extension shall be communicated to the contractor/developer by the authority in writing, within 3 months of the date of receipt of such request. Non application by the contractor/developer for extension of time shall not be a bar for giving fair and reasonable extension by the authority and this shall be binding on the contractor/developer.

Though the contract is on turnkey basis, and payment will not be on item rate, but for maintaining the records of work done, the engineer-in-charge shall, except as otherwise provided, ascertain and determine by measurement the value in accordance with the contract of work done. All measurements of all the items shall be entered by the contractor/developer and compiled in the shape of the computerized Measurement Book having pages of A-4/legal size as per format of the department so that a complete record is obtained of all the items of works performed under the contract. All such measurements and levels recorded by the contractor/developer or his authorized representative from time to time, during the progress of the work, shall be got checked by the contractor/developer from the Engineer-in-charge or his authorized representative as per interval or programme fixed in consultation with Engineer charge or his authorized representative. After the necessary corrections made by the Engineer-in-charge, the measurement sheets shall be returned to the contractor/developer for incorporating the corrections and resubmission to Engineer-in-charge for the dated signature by the Engineer-in-charge and the contractor/developer or their representative in token of their acceptance. The final, fair computerized measurement book given by the contractor/developer, duly bound, with its pages machine numbered, should be 100% correct, and no cutting or over- writing in the measurements would thereafter be allowed. If at all any error is noticed, the contractor/developer shall have to submit a fresh computerized MB with its pages duly machine numbered and bound, after getting the earlier MB cancelled by the department. Thereafter, the MB shall be taken in the SMC office records, and allotted a number as per the Register of Computerized MBs. This should be done before the corresponding bill is submitted to the SMC Office for payment. The contractor/developer shall submit two spare copies of such computerized MBs for the purpose of reference and record by the various officers of the department and the agency appointed by SMC.

The contractor/developer shall without any extra charge, provide all assistance with every appliances, labour and other things necessary for checking of measurement/ levels by the Engineer-in-charge or his representative of SMC & the agency appointed by SMC. Except where any general or detailed description of the work expressly shows to the contrary, measurements shall be taken in accordance with the procedure set forth in the specifications notwithstanding any provision in the relevant standard Method of measurement or any general or local custom. In the case of items which are not covered by specifications, measurements shall be taken in accordance with the relevant standard method of measurement issued by the Bureau of Indian Standards and if for any item no such standard is available then a mutually agreed method shall be followed. The contractor/developer shall give not less than seven days' notice to the Engineer-in-charge or his authorized representative in charge of the work before covering up or otherwise placing beyond

the reach of checking and / or test checking the measurement of any work in order that the same may be checked and / or test checked and correct dimensions thereof be taken before the same is covered up or placed beyond the reach of checking and/ or test checking measurement and shall not cover up and place beyond the reach of measurement Any work without consent in writing of the Engineer-in-charge or his authorized representative in charge of the work who shall within the aforesaid period of seven days inspect the work, and if any work shall be covered up or placed beyond the reach of checking and/ or test checking measurement without such notice having been given or the Engineer-in-charge consenting obtained in writing, the same shall be uncovered at the contractor/developer's expense, or in default thereof no payment or allowance shall be made for such work or the materials with which the same was executed.

CLAUSE 7:

Payment on Intermediate Certificate to be regarded as Advances:

No payment shall be made for work of INR 50.00 lacs/1% of the tendered amount or less as an interim bill. The interim or running account bills shall be submitted by the contractor/developer for the work executed on the basis of such recorded measurements on the format of the Department in triplicate on or before the date of every month fixed for the same by Engineer-in-charge. The contractor/developer shall not be entitled to be paid any such interim payment if the gross work done together with net payments/ adjustment of advances for the material collected, if any, in which case the interim bill shall be prepared on the appointment date of the month after the requisite progress is achieved. Engineer-in-charge shall arrange to have the bill verified by taking or causing to be taken, where necessary, the requisite measurements of the work. In the event of the failure of the contractor/developer to submit the bills, Engineer-in-charge shall prepare or cause to be prepared such bills, in which event no claims whatsoever due to delays on payment including that of interest shall be payable to the contractor/developer. Payment on account of amount admissible shall be made by the Engineer-in-charge certifying the sum to which the contractor/developer is considered entitled by way of interim payment at such rates as decided by the Engineer in-charge. The amount admissible shall be paid by 15th working day after the day of presentation of bill by the contractor/developer to Engineer-in-charge or his Assistant Engineer together with the account of the material issued by the department, or dismantled materials, if any. In case of works outside the headquarters of Engineer-in-charge, the period of 15 working days will be extended to twenty working days. All such interim payments shall be regarded as payment by way of advance against final payment only and shall not preclude the requiring of bad, unsound and imperfect or unskilled work to be rejected, removed, taken away and reconstructed or re-erected. Any certificate given by the Engineer-in- charge relating to the work done or materials delivered forming part of such payment, may be modified or corrected by any subsequent such certificate(s) or by the final certificate and shall not by itself be conclusive evidence that any work or materials to which it relates is/are in accordance with the contract and specifications. Any such interim payment, or any part thereof shall not in any respect conclude, determine or affect in anyway powers of the Engineer-in-charge under the contract or any of such payments be treated as final settlement and adjustment of accounts or in any way vary or affect the contract. Pending consideration of extension of date of completion, interim payments shall continue to be made as herein-provided without prejudice to the right of the department to take action under the terms of this contract for delay in the completion of work, if the extension of date of completions is not granted by the competent authority.

CLAUSE 8:

Completion Certificate and completion plans: Within ten days of the completion of the work, the contractor/developer shall give notice of such completion to the Engineer-in-charge and within thirty days of the receipts of such notice the Engineer-in-charge shall inspect the work and if there is no defect in the work, shall furnish the contractor/developer with a final certificate of completion, otherwise a provisional certificate of physical completion indicating defects (a) to be rectified by the contractor/developer and / or (b) for which payment will be made at reduced rates, shall be issued. But no final certificate of completion shall be issued, nor shall the work be considered to be completed until the contractor/developer shall have removed from the premises on which the work shall be executed all scaffolding, surplus materials, rubbish and all huts and sanitary arrangements required for his/ their work people on the site in connection with the execution of the works as shall have been erected or constructed by the contractor/developer(s) and cleaned off the dirt from all wood work, door, windows, walls, floor or other parts of the building, in, upon, or about which the work is to be executed or of which he may have had possession for the purpose of the execution thereof, and not until the work shall have been measured by the Engineer-in-charge. If the contractor/developer shall fail to comply with the requirements of this clause as to removal of scaffolding, surplus materials and rubbish and all huts and sanitary arrangements as aforesaid and cleaning of dirt on or before the date fixed for the completion of work, the Engineer-in-charge may at the expense of the contractor/developer remove such scaffolding, surplus materials and rubbish etc., and dispose of the same as he thinks fit and clean off such dirt as aforesaid, and the contractor/developer shall have no claim in respect of scaffolding or surplus materials as aforesaid except for any sum actually realized by the sale thereof.

CLAUSE 8A:

Contractor/developer to keep site clean:

When the annual repairs and maintenance of works are carried out, the splashes and droppings from white washing, colour washing, painting etc. on walls, floors, windows, etc. shall be removed and the surface cleaned simultaneously with the completion of these items of work in the individual rooms, quarters or premises etc. where the work is done without waiting for the actual completion of all the other items of work in the contract. In case the contractor/developer fails to comply with the requirements of this clause, the Engineer-in-charge shall have the right to get this work done at the cost of the contractor/developer weather departmentally or through any other agency. Before taking such action, the Engineer-in-charge shall give ten days' notice in writing to the contractor/developer.

CLAUSE 9:

Payment of Final Bill DELETED CLAUSE 9A:

Payment of contractor/developer's Bill to Banks DELETED

CLAUSE 10:

Materials to be provided by the contractor/developer:

The contractor/developer shall, at his own expense, provide all materials, required for the work

The contractor/developer shall, at his own expense and without delay; supply to the Engineer-in-charge samples of materials to be used on the work and shall get these approved in advance. All such materials to be provided by the contractor/developer shall be in conformity with the specifications laid down or referred to in the contract. The contractor/developer shall, if requested by the Engineer-in-charge furnish proof, to the satisfaction of the Engineer-in-charge that the materials so comply. The Engineer-in-charge shall within thirty days of supply of samples or within such further period as he may require intimate to the contractor/developer in writing whether samples are approved by him or not. If samples are not approved, the contractor/developer shall forthwith arrange to supply to the Engineer-in-charge for his approval fresh samples complying with the specifications laid down in the contract. When materials are required to be tested in accordance with specifications, approval of the Engineer-in-charge shall be issued after the test results are received. The contractor/developer shall at his risk and cost submit the samples of materials to be tested or analysed and shall not make use of or incorporate in the work any materials represented by the samples until the required tests or analysis have been made and materials finally accepted by the Engineer-in-charge. The contractor/developer shall not be eligible for any claim or compensation either arising out of any delay in the work or due to any corrective measures required to be taken on account of and as a result of testing of materials. The contractor/developer shall, at his risk and cost make all arrangements and shall provide all facilities as the Engineer-in-charge may require for collecting, and preparing the required number of samples for such tests at such time and to such place or places as may be directed by the Engineer-in charge and bear all charges and cost of testing unless specifically provided for otherwise elsewhere in the contract or specifications.

The Engineer-in-charge or his authorized representative shall at all times have access to the works and to all workshops and places where work is being prepared for from where materials, manufactured articles or machinery are being obtained for the works and the contractor/developer shall afford every facility and every assistance in obtaining the right to such access. The Engineer-in-charge shall have full powers to remove from the premises of all materials which in his opinion are not in accordance with the specifications and in case of default, the Engineer-in charge shall be at liberty to employ at the expense of the contractor/developer, other persons to remove the same without being answerable or accountable for any loss or damage that may happen or arise to such materials. The Engineer-in-charge shall also have full powers to require other proper materials to be substituted thereof and in case of default, the Engineer-in-charge may cause the same to be supplied and all costs which may attend such removal and substitution shall be borne by the contractor/developer.

The contractor/developer shall, at his own expense, provide a materials testing lab at the site for conducting routine field tests. The lab shall be equipped at least with the testing equipment's.

Dismantled Material anomic Property: The contractor/developer shall treat all materials obtained during dismantling of a structure, excavation of the site for a work, etc. as SMC property and such materials shall be disposed off to the best advantage of SMC according to the instructions in writing issued by the Engineer-in-Charge.

CLAUSE 11:

Work to be executed in Accordance with Specifications, Drawings, Orders etc.: The contractor/developer shall execute the whole and every part of the work in the most substantial and workmanlike manner both as regards materials and otherwise in every respect in strict

accordance with the specifications. The contractor/developer shall also conform exactly, fully and faithfully to the design, drawings and instructions in writing in respect of the work signed by the Engineer in-Charge and the contractor/developer shall be furnished free of charge one copy of the contract documents together with specifications, designs, drawings and instructions as are not included in the standard specifications of Central Public Works Department specified with up to date Correction Slips, or in any Bureau of Indian Standard or any other, published Standard or Code or, schedule of rates or any printed publications, or General Specification 2002 referred to elsewhere in the Contract with up to date Correction Slip, or in any Bureau of Indian Standard or any other, published standard or code or, Schedule of Rates or any other printed publication referred to elsewhere in the contract. The contractor/developer shall comply with the provisions of the contract and with the care and diligence execute and maintain the works and provide all labour and materials, tools and plants including for measurements and supervision of all works, structural plants and other things of temporary or permanent nature required for such execution and maintenance in so far as the necessity for providing these, is specified or is reasonably inferred from the contract. The Contractor/developer shall take full responsibility for adequacy, suitability and safety of all the works and methods of construction.

CLAUSE 12:

Deviations/Variations Extent and Pricing:

The Engineer-in-Charge shall have power (i) to make alternation in, omissions from, additions to, or substitutions for the original specifications, drawings, design and instructions that may appear to him to be necessary or advisable during the progress of the work, and (ii) to omit a part of the works in case of non-availability of a portion of the site or for any other reasons and the contractor/developer shall be bound to carry out the works in accordance with any instructions given to him in writing signed by the Engineer-in-Charge and such alternations, omissions, additions or substitutions shall form part of the contract as if originally provided therein and any altered, additional or substituted work which the contractor/developer may be directed to do in the manner specified above as part of the works, shall be carried out by the contractor/developer on the same conditions in all respects including price on which he agreed to do the main work except as hereafter provided.

1. The time for completion of the works shall, in the event of any deviations resulting in additional cost over the tendered value sum being ordered be extended, if requested by the contractor/developer, as follow:
 - i. In the proportion which the additional cost of the altered, additional or substituted work, bears to the original tendered value plus
 - ii. 25% of the time calculated in (i) above or such further additional time as may be considered reasonable by the Engineer-in-Charge.
 - iii. Power to extend the contract rest with Executive Engineer.

2. The provisions of the preceding paragraph shall also apply to the decrease in the rates of items for the work in excess of the limits laid down, and the Engineer-in-Charge shall after giving notice to the contractor/developer within one month of occurrence of the excess and after taking into consideration and reply received from him within fifteen days of the receipt of the notice, revise the rates for the work in question within one month of the expiry of the said period of fifteen days having regard to the market rates.
3. The contractor/developer shall send to the Engineer-in-Charge once every three months an up to date account giving complete details of all claims for additional payments to which the contractor/developer may consider himself entitled and of all additional work ordered by Engineer-in-Charge which he has executed during the preceding quarter failing which the contractor/developer shall be deemed to have waived his right. However, the Engineer-in-Charge may authorize consideration of such claims on merits.
4. For the purpose of operation, the following works shall be treated as works relating to foundation unless and otherwise defined in the contract:
 - a. For building: All works up to 1.2 meters above ground level or up to floor 1 level which is lower.
 - b. For abutments, piers and well staining: All works up to 1.2 m above the bed level.
 - c. For retaining walls, wing walls, compound wall, chimneys, overhead reservoirs/tanks and other elevated structures: All works up to 1.2 meters above the ground level.
 - d. For reservoirs/tanks (other than overhead reservoirs/tanks): All works up to 1.2 meters above the ground level.
 - e. For basement: All works up to 1.2 m above ground level or up to floor 1 level which is lower.
 - f. For roads, all items of excavation and filling including treatment of sub base.
 - g. For water supply lines, sewer lines, underground storm water drains and similar works all items of work below ground level except items of pipe work and masonry work.
 - h. For open storm water drains, all items of work except lining of drains.
5. Any operation incidental to or necessarily has to be in contemplation of tenderer while filling tender, or necessary for proper execution of the item included in the Schedule of quantities or in the schedule of rates mentioned above, whether or not, specifically indicated in the description of the item and the relevant specifications, shall be deemed to be included in the rates quoted by the tenderer or the rate given in the said of rate, as the case may be. Nothing extra shall be admissible for such operations.

CLAUSE 13:

Foreclosure of Contract due to Abandonment or Reduction in Scope of work:

If at any time after acceptance of the tender, SMC shall decide to abandon or reduce the scope of the works for any reason whatsoever and hence not require the whole or any part of the works to be carried out, the Engineer-in-Charge shall give notice in writing to that effect to the Contractor/developer and the contractor/developer shall act accordingly in the matter. The contractor/developer shall have no claim to any payment of compensation or otherwise

whatsoever, on account of any profit or advantage which he might have derived from the execution of the works in full but which he did not derive in consequence of the foreclosure of the whole or part of the work. No extra payment shall be made for the below mentioned works:

- i. Any expenditure incurred on preliminary site work, e.g. temporary access roads, temporary labour huts, staff quarters and site office; storage accommodation and water storage tanks.
- ii. SMC shall have the option to take over contractor/developer's materials or any part thereof either brought to site or of which the contractor/developer is legally bound to accept delivery from suppliers (for incorporation in or incidental to the work) provided, however, SMC shall be bound to take over the materials or such portions thereof as the contractor/developer does not desire to retain. For materials taken over or to be taken over by SMC, cost of such materials shall not be paid.
- iii. SMC shall not supply any material but, if any materials supplied by SMC are rendered surplus, the same except normal wastage shall be returned by the contractor/developer to SMC at rates not exceeding those at which these were originally issued less allowance for any deterioration or damage which may have been caused whilst the materials were in the custody of the contractor/developer. In addition, cost of transporting such materials from site to SMC stores, if so required by SMC, shall be paid.
- iv. Reasonable compensation for transfer of T& P from site to contractor/developer's permanent stores or to his other works, whichever is less. If T & P are not transported to either of the said places, no cost of transportation shall be payable.

No compensation for repatriation of contractor/developer's site staff and imported labour is paid.

CLAUSE 14:

Carrying out part work at risk & cost of contractor/developer: If Contractor/developer:

- i. At any time makes default during currency of work or does not execute any part of the work with due diligence and continues to do even after a notice in writing of 7 days in this respect from the Engineer-in-Charge: or
- ii. Commits default in complying with any of the terms and conditions of the contract and does not remedy it or takes effective steps to remedy it within 7 days even after a notice in writing is given in that behalf by the Engineer-in-Charge; or
- iii. Fails to complete the work(s) or items of work with individual dates of completion, on or before the date(s) so determined, and does not complete them within the period specific in the notice given in writing in that behalf by Engineer-in-Charge.

The Engineer-in-Charge without invoking action under Clause 3 may, without prejudice to any other right or remedy against the contractor/developer which have either accrued or accrue thereafter to Government, by a notice in writing to take the part work/ part incomplete work of any item(s) out of his hands and shall have powers to: (a) Take possession of the site and any materials, constructional plant, implements, stores etc., thereon; and /or (b) Carry out the part work/part incomplete work of any item(s) by any means at the risk and cost of the contractor/developer. The Engineer-in-Charge shall determine the amount, if any, is recoverable from the

contractor/developer for completion of the part work/part incomplete work of any item(s) taken out of his hands and execute at the risk and cost of the contractor/developer, the liability of contractor/developer on account of loss or damage suffered by SMC because of action under this clause shall not exceed 10% of the tendered value of the work. In determining the amount, credit shall be given to the contractor/developer with the value of work done in all respect in the same manner and at the same rate as if it had been carried out by the original contractor/developer under the terms of his contract, the value of contractor/developer's materials taken over and incorporated in the work and use of plant and machinery belonging to the contractor/developer. The certificate of the Engineer-in-Charge as to the value of work done shall be final and conclusive against the contractor/developer provided always that action under this clause shall only be taken after giving notice in writing to the contractor/developer. Provided also that if the expenses incurred by the department are less than the amount payable to the contractor/developer at his agreement rates, the difference shall not be payable to the contractor/developer. Any excess expenditure incurred or to be incurred by SMC in completing the part work/part incomplete work of any item(s) or the excess loss of damages suffered or maybe suffered by SMC as aforesaid after allowing such credit shall without prejudice to any other right or remedy available to Government in law or as per agreement be recovered from any money due to the contractor/developer on any account, and if such money is insufficient, the contractor/developer shall be called upon in writing and shall be liable to pay the same within 30days. If the contractor/developer fails to pay the required sum within the aforesaid period of 30days, the Engineer-in-Charge shall have the right to sell any or all the contractor/developer's unused materials constructional plant, implements, temporary building at site etc. and adjust the proceeds of sale thereof towards the dues recoverable from the contractor/developer under the contract and if thereafter there remains any balance outstanding, it shall be recovered in accordance with the provisions of the contract. In the event of above course being adopted by the Engineer-in-Charge, the contractor/developer shall have no claim to compensation for any loss sustained by him by reason of his having purchased or procured any materials or entered into any engagements or made any advance on any account or with a view to the execution of work or the performance of the contract.

CLAUSE 15: Suspension of Work:

- i. The contractor/developer shall, on receipt of the order in writing of the Engineer-in-Charge, (whose decision shall be final and binding on the contractor/developer) suspend the progress of the works or any part thereof for such time and in such manner as the Engineer-in-Charge may consider necessary so as not to cause any damage or injury to the work already done or endanger the safety thereof any of the following reasons:
 - a) On account of any default on the part of the contractor/developer or;
 - b) For proper execution of the works or part thereof for reasons other than the default of the contractor/developer; or
 - c) For safety of the works or part thereof.

The contractor/developer shall, during such suspension, properly protect and secure the works to the extent necessary and carry out the instructions given in that behalf by the Engineer-in-Charge.

- ii. If the suspension is ordered for reasons (b) and (c) in sub-Para (i) above:

- a) The contractor/developer shall be entitled to an extension of time equal to the period of every such suspension PLUS25%, for completion of the item or group of items of work for which a separate period of completion is specified in the contract and of which the suspended work forms a part, and;

b) Deleted

iii. Deleted partly

Provided, further, that the contractor/developer shall not be entitled to claim any compensation from SMC for the loss suffered by him on account of delay by SMC in the supply of materials in schedule 'B' where such delay is covered by difficulties relating to the supply of wagons, force Measure including non-allotment of such materials by controlling authorities, acts of God, acts of enemies of the state/country or any reasonable cause beyond the control of the SMC

CLAUSE 16:

Action in case Work not done as per Specifications:

All works under or in course of execution or executed in pursuance of the contract shall at all times be open and accessible to the inspection and supervision of the Engineer-in-Charge, his authorized subordinates in charge of the work and all the superior officers, Officers from Quality Assurance Cell of SMC or any organization engaged by the SMC for Quality assurance and of the Chief Technical Examiner's Office, and the contractor/developer shall, at all times, during the usual working hours and at all other times at which reasonable notice of the visit of such officers has been given to the contractor/developer, either himself be present to receive orders and instructions or have a responsible agent duly accredited in writing, present for that purpose. Orders given to the Contractor/developer's agent shall be considered to have the same force as if they had been given to the contractor/developer himself. If it shall appear to the Engineer-in-Charge or his authorized subordinates in-charge of the work or to the Executive Engineer in charge of Quality Assurance or his subordinate officers or the officers of organization engaged by the department for Quality Assurance or to Chief Technical Examiner or his subordinate officers, that any work has been executed with unsound, imperfect, or unskilful workmanship, or with materials or articles provided by him for the execution of the work which are unsound or of a quality inferior to that contracted or otherwise not in accordance with the contract the contractor/developer shall, on demand in writing which shall be made within twelve months(six months in case of work costing INR 10 Lakh and below except road work) of the completion of the work from the Engineer-in-Charge specifying the work, materials or articles complained of notwithstanding that the same may have been passed, certified and paid for forthwith rectify, or remove and reconstruct the work so specified,

In whole or in part, as the case may require or as the case may be, remove the materials or articles so specified and provide other proper and suitable materials or articles at his own charge and cost. In the event of the failing to do so within a period specified by the Engineer-in-Charge in his demand aforesaid, then the contractor/developer shall be liable to pay compensation at the same rate as under clause 2 of the contract (for non-completion of the work in time)for this default. In such case the Engineer-in-Charge may not accept the item of work at the rates applicable under the

contract but may accept such items at reduced rates as the authority specified may consider reasonable during the preparation of on account bills or final bill if the item is so acceptable without detriment to the safety and utility of the item and the structure or he may reject the work outright without any payment and/or get it and other connected and incidental items rectified, or removed and re-executed at the risk and cost of the contractor/developer. Decision of the Engineer-in-Charge to be conveyed in writing in respect of the same shall be final and binding on the contractor/developer.

CLAUSE17:

Contract Liable for damages, Defect during maintenance period:

If the contractor/developer or his working people or servants shall break, deface, injure or destroy any, part of building in which they may be working, or any building, road, road kerb, fence, enclosure, water pipe, cable, drains, electric or telephone post or wires, trees, grass or grassland, or cultivated ground contiguous to the premises on which the work or any part is being executed, or if any damage shall happen to the work while in progress, from any cause whatever or if any defect, shrinkage or other faults appear in the work within twelve months (six months in the case of work costing INR Ten lakhs and below except road work) after a certificate final or otherwise of its completion shall have been given by the Engineer-in-Charge as aforesaid arising out of defect or improper materials or workmanship the contractor/developer shall upon receipt of a notice in writing on that behalf make the same good at his own expenses or in default, the Engineer-in-Charge cause the same to be made good by other workmen and deduct the expenses from any sums that may be due or at any time thereafter may become due to the contractor/developer, or from his security deposit or the proceeds of sale thereof or of a sufficient portion thereof. In case of Maintenance and Operation works of E&M service, the security deposit deducted from contractor/developers shall be refunded within one month from the date of final payment or within one month from the date of completion of the maintenance contract whichever is earlier.

CLAUSE 18:

Contractor/developer to Supply Tools & Plants etc.:

The contractor/developer shall provide at his own cost all materials (except such special materials, if any, as may in accordance with the contract be supplied from the Engineer-in-Charge's stores), machinery tools and plants as specified. in addition to this, appliances, implements, other plants, ladders, cordage, tackle, scaffolding and temporary works required for the proper execution of the work, whether original, altered or substituted and whether included in the specifications or other documents forming part of the contract or referred to in these conditions or not, or which may be necessary for the purpose of satisfying or complying with the requirements of the Engineer-in-Charge as to any matter as to which under these conditions he is entitled to be satisfied or which he is entitled to require together with carriage there for to and from the work. The contractor/developer shall also supply without charge the requisite number of persons with the means and materials, necessary for the purpose of setting out works, and counting, weighing and assisting the measurement for examination at any time and from time to time of work or materials. Failing his so doing, the same may be provided by the Engineer-in-Charge at the expenses of the contractor/developer and the expenses may be deducted, from any money due to the contractor/developer, under this contract or otherwise and/or from his security deposit or the proceeds of sale thereof, or a sufficient portion thereof.

CLAUSE 18A:

Recovery of Compensation paid to Workmen:

In every case in which by virtue of the provisions sub-section (1) of Section 12, of the Workmen's Compensation Act, 1923, SMC is obliged to pay compensation to a workman employed by the contractor/developer, in execution of the works, SMC will recover from the contractor/developer, the amount of the compensations so paid; and, without prejudice to the rights of the Maunder sub-section(2) of Section 12, of the said Act, SMC shall be at liberty to recover such amount or any part thereof by deducting it from the security deposit or from any sum due by SMC to the contractor/developer whether under this contract or otherwise. SMC shall not be bound to contest any claim made against it under sub-section (1) Section 12, of the said Act, except on the written request of the contractor/developer and upon his giving to SMC full security for all costs for which SMC might become liable in consequence of contesting such claim.

CLAUSE 18B:

Ensuring Payment and Amenities to Workers if Contractor/developer fails:

In every case in which by virtue of the provisions of the Contractor/developer Labour (Regulation and Abolition) Act, 1970, and of the Contract Labour (Regulation and Abolition) Central Rules, 1971, SMC is obliged to pay any amounts of wages to a workman employed by the contractor/developer in execution of the works, or to incur any expenditure in providing welfare and health amenities required to be provided under the above said Act and the rules under Clause 19 H or under the Contractor/developer's Labour Regulations, or under the Rules framed by Govt. from time for the protection of health and sanitary arrangements for workers employed by SMC & its Contractor/developers. SMC will recover from the contractor/developer, the amount of wages so paid or the amount of expenditure so incurred; and without prejudice to the rights of the SMC under sub-section(2) of Section 20, and sub-section (4) of Section 21, of the Contract Labour (Regulation and Abolition) Act, 1970, SMC shall be at liberty to recover such amount or any part thereof by deducting it from the security deposit or from any sum due by SMC to the contractor/developer whether under this contract or otherwise SMC shall not be bound to contest any claim made against it under subsection(1) of Section 20, sub-section (4) of Section 21, of the said Act, except on the written request of the contractor/developer and upon his giving

to the SMC full security for all costs for which SMC might become liable in contesting such claim.

CLAUSE 19:

Labour Laws to be complied by the Contractor/developer.

The contractor/developer shall obtain a valid license under the Contractor/developer Labour (R &A) Act 1970, and the Contract Labour (Regulation and Abolition) Central Rules 1971, before the commencement of the work, and continue to have a valid license until the completion of the work. The contractor/developer shall also abide by the provisions of the Child Labour (Prohibition and

Regulation) Act, 1986. The contractor/developer shall also comply with the provisions of the building and other construction Workers (Regulation of Employment & Conditions of Service) Act, 1996 and the building another Construction Workers Welfare Cess Act, 1996. The contractor/developer shall ensure the registration of all eligible workers (inclusive of those of subcontractor/developers and petty contractor/developers) with construction workers welfare board. Any failure to fulfil these requirements shall attract the penal provisions of this contract arising out of the resultant non- execution of the work.

CLAUSE 19A:

No labour below the age of fourteen years shall be employed on the work.

CLAUSE 19B:

Payment of Wages:

- i. The contractor/developer shall pay to labour employed by him either directly or through sub-contractor/developers, wages not less than fair wages as defined in the Contractor/developer's Labour Regulations or as per the provisions of the contract Labour (Regulation and Abolition) Central Rules,1971, wherever applicable.
- ii. The contractor/developer shall, notwithstanding the provisions of any contract to the contrary, cause to be paid fair wage to labour indirectly engaged on the work, including any labour engaged by his sub-contractor/developers in connection with the said work, as if the labour had been immediately employed by him.
- iii. In respect of all labour directly or indirectly employed in the works for performance of the contractor/developer's part of this contract, the contractor/developer shall comply with or cause to be complied with the Central Public Works Department contractor/developer's Labour Regulations made by Government from time to time in regard to payment of wages, wages period, deductions from wages recovery of wages not paid and deductions un-authorized made, maintenance of wage books or wage slips, publication of scale of wages and other terms of employment, inspection and submission of periodical returns and all other matters of the like nature or as per the provisions of the Contract Labour (Regulation and Abolition) Act 1970, and the Contract Labour (Regulation and Abolition) Central Rules, 1971, wherever applicable.
- iv. (a) The Engineer-in-Charge concerned shall have the right to deduct from the money due to the contractor/developer any sum required or estimated to be required for making good the loss suffered by a worker or workers by reasons of non-fulfilment of the conditions of the contract for the benefit of the workers, non-payment of

wages or of deductions made from his or their wages which are not justified by their terms of the contract or non-observance of the Regulations.

- (b) Under the provision of Minimum Wages (Central) Rules 1950, the contractor/developer is bound to allow to the labours directly or indirectly employed in the works one day rest for 6 days continuous work and pay wages at the same rate as for duty. In the event of default, the Engineer-in-Charge shall have the right to deduct the sum or sums not paid on account of wages for weekly holidays to any labours and pay the same to the persons entitled thereto from any money due to the contractor/developer by the Engineer-in-Charge concerned. In the case of Gujarat, however, as the all-inclusive minimum daily wages fixed under Notification of the Gujarat Administration Department as amended from time to time are inclusive of wages for the weekly day of rest, the question of extra payment for weekly holidays would not arise.
- v. The contractor/developer shall comply with the provisions of the Payment of Wages Act, 1936, Minimum Wages Act, 1948, Employees Liability Act, 1938, Workmen's Compensation Act, 1923, Industrial Disputes Act, 1947, Maternity Benefits the modifications thereof or any other laws relating thereto and the rules made there under from time to time.
- vi. The contractor/developer shall indemnify and keep indemnified SMC against payment to be made under and for the observance of the laws aforesaid and the Contractor/developer's Labour Regulation without prejudice to his right to claim indemnify from his sub-contractor/developers.
- vii. The laws aforesaid shall be deemed to be a part of this contract and any breach thereof shall be deemed to be a breach of this contract.
- viii. Whatever is the minimum wage for the time being, or if the wage payable is higher than such wage, such wage shall be paid by the contractor/developer to the workmen directly without the intervention of Jamadar and that Jamadar shall not be entitled to deduct or recover any amount from the minimum wage payable to the workmen as and by way of commission or otherwise.
- ix. The contractor/developer shall ensure that no amount by way of commission or otherwise is deducted or recovered by the Jamadar from the wage of workmen.

CLAUSE 19C:

PANELTY FOR EACH DEFAULT TO PROVIDE FACILITIES:

In respect of all labour directly or indirectly employed in the work for the performance of the contractor/developer's part of this contract, the contractor/developer shall at his own expense arrange for the safety provisions as per Safety Code framed from time to time and shall at his own expense provide for all facilities in connection therewith. In case the contractor/developer fails to make arrangement and provide necessary facilities as aforesaid, he shall be liable to pay a penalty of Rs.200/- for each default and in addition the Engineer-in-Charge shall be at liberty to make

arrangement and provide facilities as aforesaid and recover the costs incurred in that behalf from the contractor/developer.

CLAUSE 19D:

The contractor/developer shall submit by the 4th and 19th of every month, to the Engineer-in-Charge a true statement showing in respect of the second half of the preceding month and the first half of the current month respectively:

- 1) The number of labours employed by him on the work.
- 2) Their working hours
- 3) The wages paid to them
- 4) The accidents that occurred during the said fortnight showing the circumstances under which they happened and the extent of damage and injury caused by them, and
- 5) The number of female workers who have been allowed maternity benefit according to **Clause 19F** and the amount paid to them.

Failing which the contractor/developer shall be liable to pay to SMC, a sum not exceeding Rs.200/- for each default or materially incorrect statement. The decision of the Engineer in charge shall be final in deducting from any bill due to the contractor/developer the amount levied as fine and be binding on the contractor/developer.

CLAUSE 19E:

In respect of all labour directly or indirectly employed in the works for the performance of the contractor/developer's part of this contract, the contractor/developer shall comply with or cause to be complied with the rules framed by Govt. from time to time for the protection of health and sanitary arrangements for workers employed by the SMC and its contractor/developers.

CLAUSE 19F:

Leave and pay during leave shall be regulated as follows:

1. Leave:

- i. In the case of delivery-maternity leave not exceeding 8 weeks, 4 weeks up to and including the day of delivery and 4 weeks following that day,
- ii. In the case of miscarriage –up to 3 weeks from the date of miscarriage.

2. Pay:

- i. In the case of delivery- leave pay during maternity leave will be at the rate of the women's average daily earning, calculated on total wages earned on the days when full time work was done during a period of three months immediately preceding the

date on which she gives notice that she expects to be confined or at the rate of Rupees one only a day whichever is greater.

- ii. In the case of miscarriage – leave pay at the rate of average daily earning calculated on the total wages earned on the days when full time work was done during a period of three months immediately preceding the date of such miscarriage.

3. CONDITIONS FOR THE GRANT OF MATERNITY LEAVE:

No maternity leave benefit shall be admissible to a woman unless she has been employed for a total period of not less than six months immediately preceding the date on which she proceeds on leave.

4. The contractor/developer shall maintain a register of Maternity (Benefit) in the Prescribed Form as shown in appendix-I and II, and the same shall be kept at the place of work.

CLAUSE 19G:

In the event of the contractor/developer(s) committing a default or breach of any of the provisions of the, Contractor/developer's Labour Regulations and Model Rules for the protection of health and sanitary arrangements for the workers as amended from time to time or furnishing any information or submitting or filing and statement under the provisions of the above Regulations and Rules which is materially incorrect, he/they shall, without prejudice to any other liability, pay to the SMC a sum not exceeding INR 200/- for every default, breach or furnishing, making, submitting, filing such materially incorrect statements and in the event of the contractor/developer(s) defaulting continuously in this respect, the penalty may be enhanced to INR 200/- per day for each day of default subject to a maximum of 5 percent of the estimated cost of the work put to tender. The decision of the Engineer-in-Charge shall be final and binding on the parties. Should it appear to the Engineer-in-Charge that the contractor/developer(s) is/ are not properly observing and complying with the provisions of the Contract's Labour Regulations and Model Rules and the provisions of the Contract Labour (Regulation and Abolition) Act 1970, and the Contract Labour (R& A) Central Rules 1971, for the protection of health and sanitary arrangements for works people employed by the contractor/developer(s) (hereinafter referred as "the said Rules") the Engineer-in-Charge shall have power to give notice in writing to the contractor/developer(s) requiring that the said Rules be complied with and the amenities prescribed therein be provided to the work people within a reasonable time to be specified in the notice. If the contractor/developer(s) shall fail within the period specified in the notice to comply with and/observe the said Rules and to provide the amenities to the work people as forfeited, the Engineer-in-Charge shall have the power to provide the amenities hereinbefore mentioned at the cost of the contractor/developer(s). the contractor/developer(s) shall erect, make and maintain at his/ their own expenses and to approved standards all necessary huts and sanitary arrangements required for his/their work people on the site in connection with the execution of the works, and if the same shall not have been created or constructed, according to approved standards, the Engineer-in-Charge shall have power to give notice in writing to the contractor/developer(s) requiring that the said huts and sanitary arrangements be remodelled and/or reconstructed according to approved standards, and if the contractor/developer(s) shall fail to remodel or reconstruct such huts and sanitary arrangements according to approved standards within the period specified in the notice, the Engineer-in-Charge shall have the power to remodel or reconstruct such huts and sanitary arrangements according to approved standards at the cost of the contractor/developer(s).

CLAUSE 19H:

The contractor/developer(s) shall at his/their own cost provide his/their labour with a sufficient number of Huts (hereinafter referred to as the camp) of the following specifications on a suitable plot of land to be approved by the Engineer-in-Charge

- a) The minimum height of each hut at the eaves level shall be 2.10 m (7 ft.) and the floor area to be provided will be at the rate of 2.7 sq. m. (30 sq. ft.) for each member of the worker's family staying with the labourer.
- b) The contractor/developer(s) shall in addition construct suitable cooking places having a minimum area of 1.80m x 1.50m (6'x5') adjacent to the hut for each family.
- c) The contractor/developer(s) shall also construct temporary latrines and urinals for the use of the labours each on the scale of not less than four per each one hundred of the total strength, separate latrines and urinals being provided for women.
- d) The contractor/developer(s) shall construct sufficient number of bathing and washing places, one unit for every 25 persons residing in the camp. These bathing and washing places shall be suitably screened.

ii

- a) All the huts shall have walls of sun-dried or burnt-bricks laid in mud mortar or other suitable local materials as may be approved by the Engineer-in-Charge. In case of sundried bricks, the walls should be plastered with mud gobri on both sides. The floor may be kutcha but plastered with mud gobri and shall be at least 15 cm (6") above the surrounding ground. The roofs shall be laid with thatch or any other materials as may be approved by the Engineer-in-Charge and the contractor/developer shall ensure that throughout the period of their occupation the roofs remain water-tight.
- b) The contractor/developer(s) shall provide each hut with proper ventilation and water tight tent.

All doors, windows, and ventilators shall be provided with suitable leaves for security purposes. There shall be kept an open space of at least 7.2m (8 yards) between a the rows of huts which may be reduced to 6m(20 ft.) according to the availability of site with the approval of the Engineer-in-Charge. Back to back construction will be allowed.

- iii. Water supply- The contractor/developer(S) shall provide adequate supply of water for the use of labourers. The provisions shall not be less than two gallons of pure and wholesome water per head per day for drinking purpose and three gallons of clean water per head per day for bathing and washing purposes. Where piped water supply is available, supply shall be at stand posts and where the supply is from wells or river, tanks which may be of metal or masonry, shall be provided. The contractor/developer(s) shall also at his/their own cost make arrangements for laying pipe lines for water supply to his /their labour camp from the existing mains wherever available, and shall pay all fees and charges therefore.

- iv. The site selected for the camp shall be high ground, removed from jungle.
- v. Disposal of Excreta- The contractor/developer(s) shall make necessary arrangements for the disposal of excreta from the latrines by trenching or incineration which shall be according to the requirements laid down by the Local Health Authorities. If trenching or incineration is not allowed, the contractor/developer(s) shall make arrangements for the removal of the excreta through the Municipal Committee/authority and inform it about the number of labourers employed so that arrangements may be made by such Committee/authority for the removal of the excreta. All charges on this account shall be borne by the contractor/developer and paid direct by him to the Municipality/authority. The contractor/developer shall provide one sweeper for every eight seats in case of dry system.
- vi. Drainage- The contractor/developer(s) shall provide efficient arrangements for draining away sludge water so as to keep the camp neat and tidy.
- vii. The contractor/developer(s) shall make necessary arrangements for keeping the camp area sufficiently lighted to avoid accidents to the workers.
- viii. Sanitation- The contractor/developer(s) shall make arrangements for conservancy and sanitation in the labour camp according to the rules of the Local Public Health and Medical Authorities.
- ix. Wherever electric connection from DISCOM is readily available the Contractor/developer would provide sufficient street-lights for the labour camp as per directions of the Engineer-in-Charge.

CLAUSE 19 I:

The Engineer-in-Charge may require the contractor/developer to dismiss or remove from the site of the work any person or persons in the contractor/developers' employ on the work who may be incompetent or misconduct himself and the contractor/developer shall forthwith comply with such requirements. In respect of maintenance /repair of renovation works etc. where the labour have an easy access to the individual houses, the contractor/developer shall issue identity cards to the labourers, whether temporary or permanent and he shall be responsible for any untoward action on the part of such labour. AE/JE will display a list of contractor/developers working in the colony/ blocks on the notice board in the colony and also at the service centre, to apprise the residents about the same.

CLAUSE 19 J:

It shall be the responsibility of the contractor/developer to see that the building under construction is not occupied by and body un-authorized during construction, and is handed over to the Engineer-in-Charge with vacant possession of complete building. If such building though completed is occupied illegally, then the Engineer-in-Charge shall have the option to refuse to accept the said building/buildings in that position. Any delay in acceptance on this account will be treated as the delay in completion and for such delay a levy up to 5% of tendered value of work may be imposed

by the C.E. whose decision shall be final both with regard to the justification and quantum and be binding on the contractor/developer. This decision of Executive Engineer will not be opened to any arbitration/litigation. However, the Executive Engineer, through a notice, may require the contractor/developer to remove the illegal occupation any time on or before construction and delivery.

CLAUSE 19 K:

Employment of skilled/semi skill worker:

The contractor/developer shall, at all stages of work, deploy skilled/semiskilled tradesmen who are qualified and possess certificate in particular trade from CPWD Training Institute/Industrial Training Institute/National Institute of construction Management and Research (NICMAR)/ National Academy of Construction, CIDC or any similar reputed and recognized Institute mandated/certified by State/Central Government. The number of such qualified tradesmen shall not be less than 20% of total skilled/semiskilled workers required in each trade at any stage of work. The contractor/developer shall submit number of man days required in respect of each trade, its scheduling and the list of qualified tradesmen along with requisite certificate from recognized Institute to Engineer in charge for approval. Notwithstanding such approval, if the tradesmen are found to have inadequate skill to execute the work of respective trade, the contractor/developer shall substitute such tradesmen within two days of written notice from Engineer-in-Charge. Failures on the part of contractor/developer to obtain approval of Engineer-in-Charge or failure to deploy qualified tradesmen will attract a compensation to be paid by contractor/developer at the rate of INR 100 per such tradesmen per day. Decision of Engineer in Charge as to whether particular tradesmen possess requisite skill and amount of compensation in case of default shall be final and binding. Provided always, that the provisions of this clause shall not be applicable for works with estimated cost put to tender being less than INR 5 Crores

CLAUSE 20:

Minimum Wages Act to be complied with:

The contractor/developer shall comply with all the provisions of the Minimum Wages Act, 1948, and Contract Labour (Regulation and Abolition) Act, 1970, amended from time to time and rules framed there under and other labour laws affecting contract labour that may be brought into force time to time.

CLAUSE 21:

Work not to be sublet. Action in case of insolvency:

The contractor/developer shall not assign or sublet without the written approval of the Engineer-in-Charge. And if the contractor/developer shall assign or sublet this contract, or attempt to do so, or become insolvent or commence any insolvency proceedings or make any composite with his creditors or attempt to do so, or if any bribe, gratuity, gift, loan, perquisite, reward or advantage pecuniary or otherwise, shall either directly or indirectly, be given, promised or offered by the contractor/developer, or any of his servants or agent to any public officer or person in the employ of Govt. in any way relating to his office or employment, or if any such officer or person shall become

in any way directly or indirectly interested in the contract, the Engineer-in-Charge on behalf of the SMC shall have power to adopt the course specified in Clause 3 hereof in the interest of SMC and in the event of such course being adopted, the consequences specified in the said Clause 3 shall ensue.

CLAUSE 22:

All sums payable by way of compensation under any of these conditions shall be considered as reasonable compensation to be applied to the use of SMC without reference to the actual loss or damage sustained and whether or not any damage shall have been sustained.

CLAUSE 23:

Changes in firm's Constitution to be intimated:

Where the contractor/developer is a partnership firm, the previous approval in writing of the Engineer-in-Charge shall be obtained before any change is made in the constitution of the firm. Where the contractor/developer is an individual or a Hindu undivided family business concern such approval as aforesaid shall likewise be obtained before the contractor/developer enters into any partnership agreement where under the partnership firm would have the right to carry out the works hereby undertaken by the contractor/developer. If previous approval as aforesaid is not obtained, the contract shall be deemed to have been assigned in contravention of Clause 21 hereof and the same action may be taken, and the same consequences shall ensue as provided in the said Clause 21.

CLAUSE 24:

All works to be executed under the contract shall be executed under the direction and subject to the approval in all respect of the Engineer-in-Charge who shall be entitled to direct at what point or points and in what manner they are to be commenced, and from time to time carried on.

CLAUSE 25: Settlement of Disputes & Arbitration:

- A. Except where otherwise provided in the contract, all questions and disputes relating to the meaning of the specifications, design, drawings and instructions herein before mentioned and as to the quality of workmanship or materials used on the work or as to any other question, claim, right, matter or thing whatsoever in any way arising out of or relating to the contract, designs, drawings, specifications, estimates, instructions, orders or these conditions or otherwise concerning the works or the execution or failure to execute the same whether arising during the progress of the work or after the cancellation, termination, completion or abandonment thereof shall be dealt with as mentioned hereinafter.

- I. If the contractor/developer considers any work demanded of him to be outside the requirements of the contract, or disputes any drawings, record or decision given in writing by the Engineer in-Charge on any matter in connection with or arising out of the contract or carrying out of the work, to be unacceptable, he shall promptly within 15

days request the City Engineer in writing for written instruction or decision. Thereupon the City engineer shall give his written instructions or decision within a period of one month from the receipts of the contractor/developer's letter.

If the Additional City Engineer fails to give his instructions or decision in writing within the aforesaid period or if the contractor/developer is dissatisfied with the instructions or decision of the receipt of Additional City Engineer's decision appeal to the Chief Engineer who shall afford an opportunity to the contractor/developer to be heard, if the later so desires, and to offer evidence in support of his appeal. The chief Engineer shall give his decision within 30 days of receipt of the Contractor/developer's Appeal. If the contractor/developer is dissatisfied with this decision, the contractor/developer shall within a period of 30 days from receipt of the decision, give notice to the Engineer Member for appointment of Arbitrator, failing which, the said decision shall be final, binding and conclusive and not referable to adjudication by the arbitrator.

- II. Except where the decision has become final, binding and conclusive in terms of Sub Para above, disputes or difference shall be referred for adjudication through arbitration by a Sole-Arbitrator, who shall be a technical person Having knowledge and experience of the trade, appointed by the Engineer –Member, SMC. It will be no objection to any such appointment that the arbitrator so appointed is a SMC employee that he had to deal with the matter to which the contract relates and that in the course of his duties as SMC employee, he has express his views in all or any of the matters in dispute of difference. If the arbitrator so appointed is unable or unwilling to act or resigns his appointment or vacates his office due to any reason whatsoever, another sole-arbitrator shall be appointed in the manner aforesaid. Such person shall be entitled to proceed with the reference from the stage at which it was left by his predecessor. Except where the decision has become final, binding and conclusive in terms of Sub Para (i) above disputes or difference shall be referred for adjudication through arbitration appointed as under: Matters to be arbitrated upon shall be referred to a sole Arbitrator where the total value of claims does not exceed INR 10.00 million. Beyond the claim limit of INR 10.00 million, there shall be three arbitrators. For this purpose the SMC will make out a panel of Engineers with the requisite qualifications and professional experience relevant to the field to which the contract relates. This panel will be from serving or retired Engineers of Central/State Government, SMC's or of Public sector. In case of a single arbitrator, the Panel will be of three Engineers, out of which the Contractor/developer will choose one. In case three arbitrators are to be appointed, the SMC will make out a panel of five. The Contractor/developer and the SMC will choose one arbitrator each and the two so chosen will choose the third arbitrator. Neither party shall be limited in the proceedings before such arbitrator(S) to the evidence nor did arguments put before the City Engineer for the purpose of obtaining his decision. The arbitration proceedings shall be held in Vadodara only. The language of proceedings that of documents and communication shall be English.

It is a term of this contract that the party invoking arbitration shall give a list of disputes with amounts claimed in respect of each such dispute Development of Integrated Housing Facility with the notice for appointment of arbitrator and giving reference to the rejection by the City Engineer of the appeal. It is also a term of this contract that no person other than a person

appointed by the Engineer Member, SMC, as aforesaid, should act as arbitrator and, if, for any reason that is not possible; the matter shall not be referred to arbitration at all. It is also a term of this contract that if the contractor/developer does not make any demand for appointment of arbitrator in respect of any claims in writing as aforesaid within 120 days of receiving the intimation from the Engineer-in-Charge that the final bill is ready for the payment, the claim of the contractor/developer shall be deemed to have been waived and absolutely barred and the SMC shall be discharged and released of all liabilities under the contract in respect of these claims. The arbitration shall be conducted in accordance with the provisions of the Arbitration and Conciliation Act, 1996 (26 of 1996) or any statutory modifications or re-enactment thereof and the rules made there under and for the time being in force shall apply to the arbitration proceeding under this clause.

It is also a term of this contract that the arbitrator shall adjudicate on only such disputes as are referred to him by the appointing authority to him and, in all cases, where the total amount of the claims by any party exceeds INR 100,000/-, the arbitrator shall give reasons for the award.

It is also a term of the contract that if any fees are payable to the arbitrator, these shall be paid equally by both the parties. It is also a term of the contract that the arbitrator shall be deemed to have entered on the reference on the date he issue the notice to both the parties calling them to submit their statement of claims and counter statement of claims. The venue of the arbitration shall be such place as may be fixed by the arbitrator in his sole discretion. The fees, if any, of the arbitrator, shall, if required, to be paid before the award is made and published, be paid half and half by each of the parties. The cost of the reference and of the award (including the fees, if any, of the arbitrator) shall be in the discretion of the arbitrator who may direct to any by whom and in what manner, such costs or any part thereof shall be paid and fix or settle the amount of costs to be so paid.

- B.** The decision of the City Engineer regarding the quantum of reduction as well as justification thereof in respect of rates for substandard work which may be decided to be accepted will be final and could not be open to Arbitration.

CLAUSE 26:

Contractor/developer to indemnify Govt. against Patent Right:

The contractor/developer shall fully indemnify and keep indemnified the SMC against and action, claim or proceeding relating to infringement or use of any patent or design or any alleged patent or design rights and shall pay any royalties which may be payable in respect of any article or part thereof included in the contract. In the event of any claims made under or action brought against SMC in respect of any such matters as aforesaid, the contractor/developer shall be immediately notified thereof and the contractor/developer shall be at liberty, at his own expenses, to settle any dispute or to conduct any litigation that may arise there from, provided that the contractor/developer shall not be liable to indemnify the SMC if the infringement of the patent or design or any alleged patent or design right is the direct result of an order passed by the Engineer-in-Charge in this behalf.

CLAUSE 27:

Lump sum Provisions in Tender:

When the estimate on which a tender is made includes lump sum in respect of parts of the works, the contractor/developer shall be entitled to payment in respect of the items of work involved or the part of the work in question at the same rates as are payable under this contract for such items, or if the part of the work in question is not, In the opinion of the Engineer-in-Charge Payable of measurement, the Engineer-in-Charge may at his discretion pay the lump sum amount entered in the estimate, and the certificate in writing of the Engineer-in-Charge shall be final and conclusive against the contractor/developer with regard to any sum or sums payable to him under the provisions of the clause

CLAUSE 28:

Action where no Specifications are specified:

In the case of any class of work for which there is no such specifications as referred to in Clause11, such work shall be carried out in accordance with the Bureau of Indian Standards Specifications. In case there are no such specifications in Bureau of Indian standards, the work shall be carried out as per manufacturer's specifications, if not available then as per district Specifications. In case there are no such specifications as required above, the work shall be carried out in all respects in accordance with the instructions and requirements of the Engineer in- Charge.

CLAUSE 29:

With- holding and lien in respect of sums due from contractor/developer:

- i. Whenever any claim or claims for payment of a sum of money arises out of or under the contract or against the contractor/developer, the Engineer-in-Charge or the SMC shall be entitled to withhold and also have a lien to retain such sum or sums in whole or in part from the security, if any, deposited by the contractor/developer and for the purpose aforesaid, the Engineer-in- Charge or the SMC shall be entitled to withhold the security deposit, if any, furnished as the case may be and also have a lien over the same pending finalization or adjudication of any such claim. In the event of the security being insufficient to cover the claimed amount or amounts or if no security has been taken from the contractor/developer, the Engineer-in-Charge or the SMC shall be entitled to withhold and have a lien to retain to the extent of such claimed amount or amounts referred to above, from any sum or sums found payable or which may at any time thereafter become payable to the contractor/developer under the same contract or any other contract with the Engineer-in-Charge of the government or any contracting person through the Engineer-in-Charge pending finalizations of adjudication of any such claim.

It is an agreed term of the contract that the sum of money or moneys so withheld or retained under the lien referred to above by the Engineer-in-Charge or SMC will be kept withheld or retained as such by the Engineer-in-Charge or SMC till the claim arising out of or

under the contract is determined by the arbitrator (if the contract is governed by the arbitrator clause) by the competent court, as the case may be and that the contractor/developer will have no claim for interest or damages whatsoever on any account in respect of such withholding as such to the contractor/developer. For the purpose of this clause, where the contractor/developer is a partnership firm or a limited company, the Engineer-in-Charge or the SMC shall be entitled to withhold and also have a lien to retain towards such claimed amount or amounts in whole or in part from any sum found payable to any partner/ limited company as the case may be, whether in his individual capacity or otherwise.

- ii. SMC shall have the right to cause an audit and technical examination of the works and the final bills of the contractor/developer including all supporting vouchers, abstract, etc., to be made after payment of the final bill and if as a result of such audit and technical examination any sum is found to have been overpaid in respect of any work done by the contractor/developer under the contract or any work claimed to have been done by him under the contract and found not to have been executed, the contractor/developer shall be liable to refund the amount of over payment and it shall be lawful for SMC to recover the same from him in the manner prescribed in sub clause (i) if this clause or in any other manner legally permissible; and it is found that the contractor/developer was paid less than what was due to him under the contract in respect of any work executed by him under it, the amount of such under payment shall be duly paid by SMC to the contractor/developer, with any interest thereon whatsoever.

Provided that the SMC shall not be entitled to recover any sum overpaid, nor the contractor/developer shall be entitled to payment or any sum paid short where such payment has been agreed upon between the City Engineer or Executive Engineer on the one hand and the contractor/developer on the other under any term of the contract permitting payment for work after assessment by the Additional City Engineer.

CLAUSE 29 A:

Lien in respect of claims in other Contracts:

Any sum of money due and payable to the contractor/developer (including the security deposit returnable to him) under the contract may be withheld or retained by way of lien by the Engineer-in Charge or the SMC any other contracting person or persons through Engineer in-Charge against any claim of the Engineer-in-Charge or SMC or such other person or persons in respect of payment of a sum of money arising out of or under any other contract made by the contractor/developer with the Engineer-in-Charge or the SMC or with such other person or persons.

It is an agreed term of the contract that the sum of money so withheld or retained under this clause by the Engineer-in-Charge or the SMC will be kept withheld or retained as such by the Engineer-in-Charge or the SMC or till his claim arising out of the same contract or any other contract is either mutually settled or determined by the arbitration clause or by the competent court, as the case may be and that the contractor/developer shall have no claim for interest or damages whatsoever on this account or on any other ground in respect of any sum of money withheld or retained under this clause and duly notified as such to the contractor/developer.

CLAUSE 30:

Unfiltered water supply:

The contractor/developer(s) shall make his/their own arrangements for water required for the work and nothing extra will be paid for the same. This will be subject to the following conditions:

- i. That the water used by the contractor/developer(s) shall be fit for construction purpose to the satisfaction of the Engineer-in-Charge.
- ii. The Engineer-in-Charge shall make alternative arrangements for supply of water at the risk and cost of contractor/developer(S) if the arrangements made by the contractor/developer(s) for procurement of water are in the opinion of the Engineer-in-Charge, unsatisfactory.

CLAUSE 31

: Alternate water arrangements:

- i. Where there is no piped water supply arrangement and the water is taken by the contractor/developer from the wells or hand pump constructed by the Government, no charge shall be recovered from the contractor/developer on the account. The contractor/developer shall, however, draw water at such hours of the day that it does not interfere with the normal use for which the hand pumps and wells are intended. He will also be responsible for all damage and abnormal repairs arising out of his use, the cost of which shall be recoverable from him. The Engineer-in-Charge shall be the final authority to determine the cost recoverable from the contractor/developer on this account and his decision shall be binding on the contractor/developer.
- ii. The contractor/developer shall be allowed to construct tube wells in SMC land for taking water for construction purpose only after he has got permission of the Engineer-in-Charge in writing. No charge shall be recovered from the contractor/developer on this account, but the contractor/developer shall be required to provide necessary safety arrangements to avoid any accidents or damage to adjacent building, roads and service lines. He shall be responsible for any accidents or damage caused due to construction and subsequent maintenance of the tube wells.

CLAUSE 32:

Hire of Plant & Machinery: Deleted CLAUSE 33: Condition relating to use of asphaltting materials:

- i. The Contractor/developer undertakes to make arrangements for the supervision of the works by the firms supplying the tar or bitumen used.
- ii. The Contractor/developer shall collect the total quantity of tar or bitumen required for the work as per standard formula before the process of painting is started and shall hypothecate it to the Engineer-in-Charge. If any bitumen or tar remains unused on completion of the work on account of lesser use of material in actual execution for reason other than authorized changes of specification and abandonment of portion of work, a corresponding deduction equivalent to the cost of unused materials as determined by the Engineer-in-Charge shall be made and material returned to the

Contractor/developers. Although the material are hypothecated to SMC the Contractor/developers under takes the responsibility for their proper watch, safe custody and protection against all risk. The material shall not be removed from site of work without the consent of the Engineer-in-Charge in writing.

- iii. The Contractor/developer shall be responsible for rectifying defects noticed within a year from the date of completion of the work. The Security Deposit relating to an asphaltic work shall be refunded after the expiry of this period.

CLAUSE 34:

Employment of Technical Staff and employees: Contractor/developers Superintendence, Supervision, Technical Staff & Employees:

- i. The contractor/developer shall provide all necessary superintendence during execution of the work and all along thereafter as may be necessary for proper fulfilling of the obligations under the contract.

The contractor/developer shall immediately after receiving letter of acceptance of tender and before commencement of the work, intimate in writing to the Engineer-in-Charge the name(s), qualifications, experience, age, address(s) and other particulars along with certificates, of the principal technical representative to be in charge of the work and other technical representative (s) who will be supervising the work. The Engineer-in-Charge shall within 3 days of receipt of such communication intimate in writing his approval or otherwise of such a representative(s) to the contractor/developer. Any such approval may at any time be withdrawn and in case of such withdrawal, the contractor/developer shall appoint another such representative(s) according to the provisions of this clause. Decision of the tender accepting authority shall be final and binding on the contractor/developer in this respect. Such a principal technical representative and other technical representative(s) shall be appointed by the contractor/developer soon after receipt of the approval from Engineer-in-Charge and shall be available at site before start of work.

All the provisions applicable to the principal technical representative under the Clause will also be applicable to other technical representative(s). The principal technical representative and other technical representative (s) shall be present at the site of work for supervision at all times when any construction activity is in progress and also present himself/themselves, as required, to the Engineer-in-Charge and/or his designated representative, to take instructions. Instructions given to the principal technical representative or other technical representative(s) shall be deemed to have the same force as if these have been given to the contractor/developer. The principal technical representative and other technical representative(s) shall be actually available at site fully during all stage of execution of work, during recording/checking /test checking of measurements of works and whenever so required by the Engineer-in-Charge and shall also note down instructions conveyed by the Engineer-in-Charge or his designated representative(s) in the site order book and shall affix his/their signature in token of noting down the instructions and in token of acceptance of measurements/checked measurement/ test checked measurements. The representative(s) shall not look after any other work. Substitutes, duly approved by Engineer-in-Charge of the work in similar manner as aforesaid shall be provided in event of absence of any of the representative(s) by more than two days.

If the Engineer-in- charge, whose decision in this respect is final and binding on the contractor/developer, is convinced that no such technical representative(s) is/are effectively

appointed or is/are effectively attending or fulfilling the provision of this clause , a recovery (non-refundable) shall be effected from the contractor/developer as specified in Schedule 'B' and the decision of the Engineer-in-Charge as recorded in the site order book and measurement recorded checked/test checked in Measurement Books shall be final and binding on the contractor/developer. Further if the contractor/developer fails to appoint suitable technical Principal technical representative and/or other technical representative(s) and if such appointed persons are not effectively present or are absent by more than two days without duly approved substitute or do not discharge their responsibilities satisfactory, the Engineer-in-Charge shall have full powers to suspend the execution of the work until such date as suitable other technical representative(s) is/are appointed and the contractor/developer shall be held responsible for the delay so caused to the work. The contractor/developer shall submit a certificate of employment of the technical representative(s) along with every on account bill/final bill and shall produce evidence at any time so required by the Engineer-in-Charge.

- ii. The contractor/developer shall provide and employ on the site only such technical assistants as are skilled and experienced in their respective fields and such foremen and supervisory staff as are competent to give proper supervision to the work.

The contractor/developer shall provide and employ skilled, semiskilled and unskilled labour as is necessary for proper and timely execution of the work. The Engineer-in-Charge shall be at liberty to object to and require the contractor/developer to remove from the works any person who in his opinion misconducts himself, or is incompetent or negligent in the performance of his duties or whose employment is otherwise considered by the Engineer-in-Charge to be undesirable. Such person shall not be employed again at works site without the written permission of the Engineer-in-Charge and the persons so removed shall be replaced as soon as possible by competent substitutes. The technical staff required at site as per quantum of work but minimum at each site, as per table below.

MINIMUM REQUIREMENT OF TECHNICAL REPRESENTATIVE(S) Employment of a qualified site engineer by contractor/developer (Package wise): The contractor/developer shall employ full time technically qualified staff during the execution of this work as under:

- One Project Manager B.E./B. Tech. Civil having 10 years of experience
- One Graduate Civil Engineers for Two High rise towers & Two Diploma Civil Engineers for each tower.
- Junior Electrical site Engineer having Diploma in Electrical with 5 years experience.

The Engineer employed must have sufficient experience to handle the work independently. Such an Engineer shall have to stay at the site of work and he shall not be entrusted with any other duty except of this work. The site in charge/Resident Engineer shall have a Bachelors Degree in Civil Engineering and have a minimum experience of 10 years. Note: No. of persons will depend on the size of project and as per instruction of Engineer in charge.

CLAUSE 35: Levy/ Taxes payable by Contractor/developer:

1. Sales-Tax / VAT, service tax, Building and other Construction Workers Welfare Cess or any other tax or Cess in respect of this contract shall be payable by the contractor/developer and SMC shall not entertain any claim whatsoever in this respect.

2. The contractor/developer shall deposit royalty and obtain necessary permit for supply of the red bajri, stone, kankar, etc. from local authorities.
3. If pursuant to or under any law, notification or order any royalty, cess or the like becomes payable by the Government of India and does not any time become payable by the contractor/developer to the State Government, Local authorities in respect of any material used by the contractor/developer in the works then in such a case, it shall be lawful to the SMC and it will have the right and be entitled to recover the amount paid in the circumstances as aforesaid from dues of the contractor/developer.

CLAUSE 36: Conditions for reimbursement of levy/taxes if levied after receipt of tenders:

1. All tendered rates shall be inclusive of all taxes and levies payable under respective statutes. However, if any further Tax or levy or Cess is imposed by statutes, after the last stipulated date for the receipt of tender including extensions if any and the Contractor/developer thereupon necessarily and properly pays such taxes/levies/cess, shall not be reimbursed by SMC.

CLAUSE 37: Termination of Contract on death of contractor/developer: Without prejudice to any of the rights or remedies under this contract if the contractor/developer dies, if no person ready to take responsibility of contract, SMC shall have the option of terminating the contract without compensation to the contractor/developer.

CLAUSE 38: If Near relative working in SMC then the contractor/developer not allowed to tender:

The contractor/developer shall not be permitted to tender for works in the SMC circle (Division in case of contractor/developer of Horticulture/Nursery Categories) responsible for award and execution of contraction which his near relative is posted as Divisional Accountant or as an office of any capacity between the grades of Executive Engineer-and Junior Engineer(both inclusive). He shall also intimate the names of persons who are working with him in any capacity or are subsequently employed by him and are near relatives to any Gazetted Officer in the SMC or in the Ministry of Urban Development. Any breach of this condition by the contractor/developer would render him liable to be removed from the approved list of contractor/developer of this Department. If however the contractor/developer is registered in any other department, he shall be debarred from tendering in SMC for any breach of this condition. Note: by the term "Near relatives" is meant wife, husband, parents and grandparents, children and grand-children, brothers and sisters, uncles, aunts and cousins and their corresponding in laws.

CLAUSE 39: NO Gazetted Engineer to work as Contractor/developer within two year of retirement:

No engineer of gazetted rank or other gazette officer employed in engineering or administrative duties in an engineering department of the SMC shall work as contractor/developer or employee of a contractor/developer for a period of two years after his retirement from Government service without the previous permission of SMC in writing. This contract is liable to be cancelled if either the contractor/developer or any of his employees is found at any time to be such a person who had not obtained the permission of SMC as aforesaid, before submission of the tender of engagement in the contractor/developer's service, as the case may be. **CLAUSE 40: Recovery for lesser material issued/consumed:** Quantity of cement & bitumen shall be calculated on the basis of quantity of cement and bitumen required for different items or work as per standard consumption, with up to

date overall consumption will be checked at the time of final bill, if any material consumed is less than standard norms, same amount shall be recovered from final bill.

CLAUSE 41:

The work (whether fully constructed or not) and all materials, machines, tools and plants, scaffolding, temporary buildings and other things connected there-with shall be at the risk of the contractor/developer until the work has been delivered to the Engineer-in-Charge and a certificate from him to that effect obtained. In the event of the work or any materials properly brought to the site for incorporation in the work being damaged or destroyed in consequence of hostilities or warlike operation, the contractor/developer shall when ordered (in writing) by the Engineer-in-Charge to remove any debris from the site, collect and properly stack or remove in store all serviceable materials salvaged from the damaged work and shall be paid at the contract rate in accordance with the provision of this agreement for the work of clearing the site of debris, stacking or removal of serviceable materials and for reconstruction of all works ordered by the Engineer-in-Charge, such payments being in addition to compensation up to the value of the work originally executed before being damaged or destroyed and not paid for. In case of works damaged or destroyed but already measured and paid for, the compensation shall be assessed by the Executive Engineer concerned. The contractor/developer shall be paid for the damages/ destruction suffered and for the restoring the material at the rate based on analysis of rates tendered for in accordance with the provision of the contract. The certificate of the Engineer-in-Charge regarding the quantity and quantity of materials and purpose for which they were collected shall be final and binding on all parties to this contract. Provided always that no compensation shall be payable for any loss in consequence of hostilities or warlike operations (s) unless the contractor/developer had taken all such precautions against air raid as are deemed necessary by Engineer-in-Charge In the event of the contractor/developer having to carry out the reconstruction as aforesaid, he shall be allowed such extension of time for its completion as is considered reasonable by the Divisional Officer.

CLAUSE 42:

Apprentices Act provisions to be complied with:

The contractor/developer shall comply with the provisions of the Apprentices Act, 1961 and the rules and orders issued there under from time to time. If he fails to do so, his failure will be a breach of the contract and the Executive Engineer may, in his discretion, cancel the contract. The contractor/developer shall also be liable for any pecuniary liability arising on account of any violation by him of the provisions of the said Act.

CLAUSE 43:

Labour clearance:

As soon as the work is virtually complete the contractor/developer shall apply for the clearance certificate to the Labour Officer. Contractor/developer has to produce Labour clearance certificate on demand of Engineer in charge.

CLAUSE 44:

Provision for project financing and renewable leasehold rights in concession agreement.

- **The Concessionaire /developer shall arrange all the funding for the development and construction of the slum rehabilitation/ redevelopment scheme from its own resources or through loans or financial assistance arranged by it at its cost and risk and the Surat Municipal Corporation shall not be liable in respect there of in any manner whatsoever.**
- **The Concessionaire / developer shall be allowed to raise project finance in slum PPP;**

Only for this Project , Nontransferable, development, renewable leasehold rights on the sub plot meant for free sale use to the extent land premium is paid, in case of default, first charge will be on the asset created by the developer on the said sub plot.

- **The Concessionaire/developer shall indemnify and keep indemnified the all competent authority involved , its agencies, and employees from and against all losses, cost, benefits and / or Obligations under this agreement pursuant to any direction of government of Gujarat or by operation of law or in the course of its business.**

SAFETY CODE

1. Suitable scaffolds should be provided for workmen for all works that cannot safely be done from the ground, or from solid construction except such short period work as can be done safely from ladders. When a ladder is used, an extra mazdoor shall be engaged for holding the ladder and if the ladder is used for carrying materials as well suitable footholds and hand-hold shall be provided on the ladder and the ladder shall be given an inclination not steeper than 1/4 to 1 (1/4 horizontal and 1 vertical).
2. Scaffolding of staging more than 3.6m (12ft.) above the ground or floor, swung or suspended from an overhead support or erected with stationary support shall have a guard rail properly attached or bolted, braced and otherwise secured at least 90 cm. (3ft.) high above the floor or platform of such scaffolding or staging and extending along the entire length of the outside and ends thereof with only such opening as may be necessary for the

delivery of materials. Such scaffolding or staging shall be so fastened as to prevent it from swaying from the building or structure.

3. Working platforms, gangways and stairways should be so constructed that they should not sag unduly or unequally, and if the height of the platform or the gangway or the stairway is more than 3.6m (12ft.) above ground level or floor level, they should be closely boarded, should have adequate width and should be suitably fastened as described in (2) above.
4. Every opening in the floor of a building or in a working platform shall be provided with suitable means to prevent the fall of person or materials by providing suitable fencing or railing whose minimum height shall be 90 cm (3ft.).
5. Safe means of access shall be provided to all working platforms and other working places. Every ladder shall be securely fixed. No portable single ladder shall be over 9m. (30ft.) in length while the width between side rails in rung ladder shall in no case be less than 29 cm. (11½") for ladder up to and including 3m. (10ft.) in length. For longer ladder, this width should be increased at least ¼" for each additional 30cm. (1 foot) of length. Uniform step spacing of not more than 30 cm shall be kept. Adequate precautions shall be taken to prevent danger from electrical equipment. No materials on any of the sites or work shall be so stacked or placed as to cause danger or inconvenience to any person or the public. The developer shall provide all necessary fencing and lights to protect the public from accident and shall be bound to bear the expenses of defense of every suit, action or other proceedings at law that may be brought by any person for injury sustained owing to neglect of the above precautions and to pay any damages and cost which may be awarded in any such suit, action or proceedings to any such person or which may, with the consent of the developer, be paid to compensate any claim by any such person.
6. Excavation and Trenching: – All trenches 1.2m. (4ft.) or more in depth, shall at all times be supplied with at least one ladder for each 30m. (100ft.) in length or fraction thereof Ladder shall extend from bottom of the trench to at least 90 cm. (3ft.) above the surface of the ground. The side of the trenches which are 1.5m. (5ft.) or more in depth shall be stepped back to give suitable slope or securely held by timber bracing, so as to avoid the danger of sides collapsing. The excavated materials shall not be placed within 1.5m. (5ft.) of the edges of the trench or half of the depth of the trench whichever is more. Cutting shall be done from top to bottom. Under no circumstances undermining or undercutting shall be done.
7. Demolition: – Before any demolition work is commenced and also during the progress of the work.
 - i) All roads and open areas adjacent to the work site shall either be closed or suitably protected.
 - ii) No electric cable or apparatus which is liable to be a source of danger or a cable or apparatus used by the operator shall remain electrically charged.

- iii) All practical steps shall be taken to prevent danger to persons employed from risk of fire or explosion or flooding. No floor, roof or other part of the building shall be so overloaded with debris or materials as to render it unsafe.
8. All necessary personal safety equipment as considered adequate by the Engineer-in-Charge should be kept available for the use of the person employed on the site and maintained in a condition suitable for immediate use, and the developer should take adequate steps to ensure proper use of equipment by those concerned:

THE FOLLOWING SAFETY EQUIPMENT SHALL INVARIABLY BE PROVIDED.

- i) Workers employed on mixing asphaltic materials, cement and lime mortars shall be provided with protective footwear and protective goggles.
 - ii) Those engaged in white washing and mixing or stacking of cement bags or any material which is injurious to the eyes shall be provided with protective goggles.
 - iii) Those engaged in welding works shall be provided with welder's protective eye-shields.
 - iv) Stone breaker shall be provided with protective goggles and protective clothing and seated at sufficiently safe intervals.
 - v) When workers are employed in sewers and manholes, which are in active use, the developers shall ensure that the manhole covers are opened and ventilated at-least for an hour before the workers are allowed to get into the manholes, and the manholes so opened shall be cordoned off with suitable railing and provided with warning signals or boards to prevent accident to the public. In addition, the developer shall ensure that the following safety measure are adhered to
- a) Entry for workers into the line shall not be allowed except under supervision of the JE or any other higher officer.
 - b) At least 5 to 6 manholes upstream and downstream should be kept open for at least 2 to 3 hours before any man is allowed to enter into the manhole for working inside.
 - c) Before entry presence of Toxic gases should be tested by inserting wet lead acetate paper which changes colour in the presence of such gases and gives indication of their presence.
 - d) Presence of Oxygen should be verified by lowering a detector lamp into the manhole. In case, no Oxygen is found inside the sewer line, workers should be sent only with Oxygen kit.
 - e) Safety belt with rope should be provided to the workers. While working inside the manholes such rope should be handled by two men standing outside to enable him to be pulled out during emergency.
 - f) The area should be barricaded or cordoned off by suitable means to avoid mishaps of any kind. Power warning signs should be displayed for the safety of the public whenever cleaning works are undertaken during night or day.

- g) No smoking or open flames shall be allowed near the blocked manhole being cleaned.
- h) The malba obtained on account of cleaning of blocked manholes and sewer lines should be immediately removed to avoid accidents on account of slippery nature of the malba.
- i) Workers should not be allowed to work inside the manhole continuously. He should be given rest intermittently. The Engineer-in-Charge may decide the time up to which a worker may be allowed to work continuously inside the manhole. Gas masks with Oxygen Cylinder should be kept at site for use in emergency.
- j) Air-blowers should be used for flow of fresh air through the manholes. Whenever called for portable air blowers are recommended for ventilating the manholes. The Motors for these shall be vapor proof and of totally enclosed type. Non sparking gas engines also could be used but they should be placed at least 2 meters away from the opening and on the leeward side protected from wind so that they will not be a source of friction on any inflammable gas that might be present.
- k) The workers engaged for cleaning the manholes/sewers should be properly trained before allowing working in the manhole.
- l) The workers shall be provided with Gumboots or non-sparking shoes bump helmets and gloves non sparking tools safety lights and gas masks and portable air blowers (when necessary). They must be supplied with barrier cream for anointing the limbs before working inside the sewer lines.
- m) Workmen descending a manhole shall try each ladder stop or rung carefully before putting his full weight on it to guard against insecure fastening due to corrosion of the rung fixed to manhole well.
- n) If a man has received a physical injury, he should be brought out of the sewer immediately and adequate medical aid should be provided to him.
- o) The extents to which these precautions are to be taken depend on individual situation but the decision of the Engineer-in-Charge regarding the steps to be taken in this regard is an individual case will be final.
- vi) The Developer shall not employ men and women below the age of 18 years on the work of painting with products containing lead in any form. Wherever men above the age of 18 are employed on the work of lead painting, the following precaution should be taken :
 - a) No paint containing lead or lead products shall be used except in the form of paste or readymade paint.
 - b) Suitable face masks should be supplied for use by the workers when paint is applied in the form of spray or a surface having lead paint is dry rubbed and scraped.

- c) Overalls equipment shall be supplied by the developers to the workmen and adequate facilities shall be provided to enable the working painters to wash during and on the cessation of work.
 - d) An additional clause (viii) (i) of Safety Code (iv) the Developer shall not employ women and men below the age of 18 on the work of painting with product contained lead in any form. Wherever men above the age of 18 are employed on the work of lead painting, the following principles must be observed for such use:
 - a. White lead, sulphate of lead or product containing these pigment, shall not be used in painting operation except in the form of pastes or paint ready for use.
 - b. Precautionary Measures shall be taken, wherever required in order to prevent danger arising from the application of paint in the form of spray.
 - c. Precautionary Measures shall be taken, wherever practicable, to prevent danger arising out of from dust caused by dry rubbing down and scraping.
 - d. Adequate facilities shall be provided to enable working painters to wash during and on cessation of work.
 - e. Overall shall be worn by working painters during the whole of working period.
 - f. Suitable arrangement shall be made to prevent clothing put off during working hours being spoiled by painting materials.
 - g. Cases of lead poisoning and suspected lead poisoning shall be notified and shall be subsequently verified by medical man appointed by competent authority of SMC
 - h. SMC may require, when necessary medical examination of workers.
 - i. Instructions with regard to special hygienic precautions to be taken in the painting trade shall be distributed to working painters.
9. When the work is done near any place where there is risk of drowning, all necessary equipments should be provided and kept ready for use and all necessary steps taken for prompt rescue of any person in danger and adequate provision, should be made for prompt first aid treatment of all injuries likely to be obtained during the course of the work.
10. Use of hoisting machines and tackle including their attachments, anchorage and supports shall conform to the following standards or conditions:
- i) a) These shall be of good mechanical construction, sound materials and adequate strength and free from patent defects and shall be kept repaired and in good working order.

- b) Every rope used in hoisting or lowering materials or as a means of suspension shall be of durable quality and adequate strength, and free from patent defects.
 - ii) Every crane driver or hoisting appliance operator shall be properly qualified and no person under the age of 21 years should be in charge of any hoisting machine including any scaffolding which or give signals to operator.
 - iii) In case of every hoisting machine and of every chain ring hook, shackle swivel and pulley block used in hoisting or as means of suspension, the safe working load shall be ascertained by adequate means. Every hoisting machine and all gear referred to above shall be plainly marked with the safe working load. In case of a hoisting machine having a variable safe working load and the condition under which it is applicable shall be clearly indicated. No part of any machine or any gear referred to above in this paragraph shall be loaded beyond the safe working load except for the purpose of testing.
 - iv) In case of departmental machines, the safe working load shall be notified by the Electrical Engineer-in-Charge. As regards developer's machines the developers shall notify the safe working load of the machine to the Engineer-in-Charge whenever he brings any machinery to site of work and get it verified by the Electrical Engineer concerned.
11. Motors, gearing transmission, electric wiring and other dangerous parts of hoisting appliances should be provided with efficient safeguards. Hoisting appliances should be provided with such means as will reduce to the minimum the risk of accidental descent of the load. Adequate precautions should be taken to reduce to the minimum the risk of any part of a suspended load becoming accidentally displaced. When workers are employed on electrical installations which are already energized, insulating mats, wearing apparel, such as gloves, sleeves and boots as may be necessary should be provided. The worker should not wear any rings, watches and carry keys or other materials which are good conductors of electricity.
12. All scaffolds, ladders and other safety devices mentioned or described herein shall be maintained in safe condition and no scaffold, ladder or equipment shall be altered or removed while it is in use. Adequate washing facilities should be provided at or near places of work.
13. These safety provisions should be brought to the notice of all concerned by display on a notice board at a prominent place at work spot. The person responsible for compliance of the safety code shall be named therein by the developer.
14. To ensure effective enforcement of the rules and regulations relating to safety precautions the arrangements made by the developer shall be open to inspection by the Labour Officer or Engineer-in-Charge of the department or their representatives.

15. Notwithstanding the above clauses from 1 to 15 there is nothing in these to exempt the developer from the operations of any other Act or Rule in force in the Republic of India.

MODEL RULES FOR THE PROTECTION OF HEALTH AND SANITARY ARRANGEMENTS FOR WORKERS EMPLOYED BY SMC OR ITS DEVELOPERS

1. APPLICATION:

These rules shall apply to all buildings and construction works in charge of SMC in which twenty or more workers are ordinarily employed or are proposed to be employed in any day during the period during which the contract work is in progress. 2. DEFINITION: Work place means a place where twenty or more workers are ordinarily employed in connection with construction work on any day during the period during which the contract work is in progress. 3. FIRST-AID FACILITIES: At every work place there shall be provided and maintained, so as to be easily accessible during working hours, first-aid boxes at the rate of not less than one box for 150 contract labour or part thereof ordinarily employed. The first-aid box shall be distinctly marked with a red cross on white background and shall contain the following equipment:

- a) For work places in which the number of contract labour employed does not exceed 50 each first aid box shall contain the following equipments:
- 6 small sterilized dressings.
 - 3 medium size sterilized dressings.
 - 3 large size sterilized dressings.
 - 3 large sterilized burn dressings.
 - 1 (30 ml.) bottle containing a two percent alcoholic solution of iodine.
 - 1 (30 ml.) bottle containing salvolatile having the dose and mode of administration indicated on the label.
 - 1 snakebites lancet.
 - 1 (30 gms.) bottle of potassium permanganate crystals.
 - 1 pair scissors.
 - 1 copy of the first aid leaflet issued by the Director General, Factory Advice Service and Labour Institutes, Government of India.
 - 1 bottle containing 100 tables (each of 5 gms) of aspirin.
 - Ointment for burns.
 - A bottle of suitable surgical antiseptic solution.
- b) For work places in which the number of contract labour exceed 50 each first –aid box shall contain the following equipments.
- 12 small sterilized dressings.
 - 6 small size sterilized dressings.
 - 6 large size sterilized dressings.

- 6 large size sterilized burn dressings.
 - 6 (15 gms.) packets sterilized cotton wool.
 - 1 (60 ml.) bottle containing a two percent alcoholic solution iodine.
 - 1 (60 ml.) bottle containing Sal volatile having the dose and mode of administration indicated on the label.
 - 1 roll of adhesive plaster.
 - 1 snake bite lancet.

 - 1 (30 gms.) bottle of potassium permanganate crystals.
 - 1 pair scissors.
 - 1 copy of the first-aid leaflet issued by the Director General Factory Advice Service and Labour Institutes/ Government of India.
 - A bottle containing 100 tablets (each of 5 gms.) of aspirin.
 - Ointment for burns.
 - A bottle of suitable surgical antiseptic solution.
- c) Adequate arrangements shall be made for immediate recoupment of the equipment when necessary.
- d) Nothing except the prescribed contents shall be kept in the First-aid box.
- e) The first-aid box shall be kept in charge of a responsible person who shall always be readily available during the working hours of the work place.
- f) A person in charge of the First-aid box shall be a person trained in First-aid treatment, in the work places where the number of contract labour employed is 150 or more.
- g) In work places where the number of contract labour employed is 500 or more and hospital facilities are not available within easy distance from the works. First-aid posts shall be established and run by a trained compo under. The compounder shall be on duty and shall be available at all hours when the workers are at work.
- h) Where work places are situated in places which are not towns or cities, a suitable motor transport shall be kept readily available to carry injured person or person suddenly taken ill to the nearest hospital.

4. DRINKING WATER:

- i) In every work place, there shall be provided and maintained at suitable places, easily accessible to labour, a sufficient supply of cold water fit for drinking.
- ii) Where drinking water is obtained from an intermittent public water supply, each work place shall be provided with storage where such drinking water shall be stored.
 - Every water supply or storage shall be at a distance of not less than 50 feet from any latrine drain or other source of pollution. Where water has to be drawn from an existing well which is within such proximity of latrine, drain or any other source of pollution, the well shall be properly chlorinated before water is drawn from it for drinking. All such wells shall be entirely closed in and be provided with a trap door which shall be dust and waterproof.
 - A reliable pump shall be fitted to each covered well, the trap door shall be kept locked and opened only for cleaning or inspection which shall be done at least once a month.
 - The developer shall supply only potable water in the labour camp sample of water shall be drawn from the source of water supply in the labour camps every months and got tested from the Municipal Corporation's lab by the developer .Wherever drinking water is supplied to the labour camps through tankers. Samples shall be drawn from the tankers and got tested. Water storage tanks chlorine tablets shall be added from time to time as per requirement so that portability of water remains intact No extra payment shall be made on this account.

5. WASHING FACILITIES:

- (a) In every work place adequate and suitable facilities for washing shall be provided and maintained for the use of contract labour employed therein.
- (b) Separate and adequate cleaning facilities shall be provided for the use of male and female workers.
- (c) Such facilities shall be conveniently accessible and shall be kept in clean and hygienic condition.

6. LATRINES AND URINALS:

- a. Latrines shall be provided in every work place on the following scale namely :
 - Where female are employed there shall be at least one latrine for every 25 females.

- Where males are employed, there shall be at least one latrine for every 25 males.
- Provided that where the number of males or females exceeds 100, it shall be sufficient if there is one latrine for 25 males or females as the case may be up to the first 100, and one for every 50 thereafter.
- a. Every latrine shall be under cover and so partitioned off as to secure privacy, and shall have a proper door and fastenings.
- b. Construction of latrines: The inside walls shall be constructed of masonry or some suitable heat-resisting nonabsorbent materials and shall be cement washed inside and outside at least once a year, Latrines shall not be of a standard lower than borehole system.
- c. Where workers of both sexes are employed, there shall be displayed outside each block of latrine and urinal, a notice in the language understood by the majority of the workers "For Men only" or "For Women Only" as the case may be both in English and Gujarati.

The notice shall also bear the figure of a man or of a woman, as the case may be.
- d. There shall be at least one urinal for male workers up to 50 and one for female workers up to fifty employed at a time, provided that where the number of male or female workmen, as the case may be exceeds 500, it shall be sufficient if there is one urinal for every 50 males or females up to the first 500 and one for every 100 or part thereafter.
- e. a) The latrines and urinals shall be adequately lighted and shall be maintained in a clean and sanitary condition at all times.
- f. Latrines and urinals other than those connected with a flush sewage system shall comply with the requirements of the Public Health Authorities.
- g. Water shall be provided by means of tap or otherwise so as to be conveniently accessible in or near the latrines and urinals.
- h. Disposal of excreta: Unless otherwise arranged for by the local sanitary authority, arrangements for proper disposal of excreta by incineration at the work place shall be made by means of a suitable incinerator. Alternately excreta may be disposed of by putting a layer of night soil at the bottom of a pucca tank prepared for the purpose and covering it with a 15 cm. Layer of waste or refuse and then covering it with a layer of earth for a fortnight (when it will turn to manure)

- i. The developer shall at his own expense, carry out all instructions issued to him by the Engineer-in-Charge to effect proper disposal of night soil and other conservancy work in respect of the developer's workmen or employees on the site. The developer shall be responsible for payment of any charges which may be levied by Municipal or Cantonment Authority for execution of such on his behalf.

7. PROVISION OF SHELTER DURING REST:

At every place there shall be provided, free of cost, four suitable sheds, two for meals and the other two for rest separately for the use of men and women labour. The height of each shelter shall not be less than 3 meters (10 ft.) from the floor level to the lowest part of the roof. These shall be kept clean and the space provided shall be on the basis of 0.6 Sqm (6 sqft.) per head. Provided that the Engineer-in-Charge may permit subject to his satisfaction, a portion of the building under construction or other alternative accommodation to be used for the purpose.

8. CRECHES:

- i) At every work place, at which 20 or more women worker are ordinarily employed, there shall be provided two rooms of reasonable dimensions for the use of their children under the age of six years. One room shall be used as a play room for the children and the other as their bedroom. The rooms shall be constructed with specifications as per clause 19H (ii) a, b & c.
- ii) The rooms shall be provided with suitable and sufficient openings for light and ventilation. There shall be adequate provision of sweepers to keep the places clean.
- iii) The developer shall supply adequate number of toys and games in the play room and sufficient number of cots and beddings in the bed room.
- iv) The developer shall provide one Ayah to look after the children in the crèche when the number of women workers does not exceed 50 and two when the number of women workers exceeds 50. *Development of Integrated Housing Facility*
- v) The use of the rooms earmarked as crèches shall be restricted to children, their attendants and mothers of the children.

9. CANTEENS:

- i) In every work place where the work regarding the employment of contract labour is likely to continue for six months and where in contract labour numbering one hundred or more is ordinarily employed, an adequate canteen shall be provided by the developer for the use of such contract labour.
- ii) The canteen shall be maintained by the developer in an efficient manner.
- iii) The canteen shall consist of at least a dining hall, kitchen, store room, pantry and washing places separately for workers and utensils.

- iv) The canteen shall be sufficiently lighted at all times when any person has access to it. v) The floor shall be made of smooth and impervious materials and inside walls shall be lime-washed or colour washed at least once in each year.
- v) Provided that the inside walls of the kitchen shall be lime-washed every four months.
- vi) The premises of the canteen shall be maintained in a clean and sanitary condition.
- vii) Waste water shall be carried away in suitable covered drains and shall not be allowed to accumulate so as to cause a nuisance.
- viii) Suitable arrangements shall be made for the collection and disposal of garbage.
- ix) The dining hall shall accommodate at a time 30 percent of the contract labour working at a time.
- x) The floor area of the dining hall, excluding the area occupied by the service counter and any furniture except tables and chairs shall not be less than one square meter (10 sft.) per diner to be accommodated as prescribed in sub-Rule 9.
 - a) A portion of the dining hall and service counter shall be partitioned off and reserved for women workers in proportion to their number.
 - b) Washing places for women shall be separate and screened to secure privacy.
- xi) Sufficient tables stools, chair or benches shall be available for the number of diners to be accommodated as prescribed in sub-Rule 9.
- There shall be provided and maintained sufficient utensils crockery, furniture and any other equipment necessary for the efficient running of the canteen.
- The furniture utensils and other equipment shall be maintained in a clean and hygienic condition.
- Suitable clean clothes for the employees serving in the canteen shall be provided and maintained.
- A service counter, if provided, shall have top of smooth and impervious material.
- Suitable facilities including an adequate supply of hot water shall be provided for the cleaning of utensils and equipments.
- xii) The food stuffs and other items to be served in the canteen shall be in conformity with the normal habits of the contract labour.
- xiii) The charges for food stuffs, beverages and any other items served in the canteen shall be based on 'No profit, No losses and shall be conspicuously displayed in the canteen.
- xiv) In arriving at the price of foodstuffs, and other article served in the canteen, the following items shall not be taken into consideration as expenditure namely:
 - a) The rent of land and building

- b) The depreciation and maintenance charges for the building and equipments provided for the canteen.
- c) The cost of purchase, repairs and replacement of equipments including furniture, crockery, cutlery and utensils.
- d) The water charges and other charges incurred for lighting and ventilation.
- e) The interest and amounts spent on the provision and maintenance of equipments provided for the canteen.
- xvii) The accounts pertaining to the canteen shall be audited once every 12 months by registered accountants and auditors.

10. DENGU/ANTI-MALARIAL PRECAUTIONS:

The developer shall at his own expense, conform to all anti-malarial instructions given to him by the Engineer-in-Charge including the filling up of any borrow pits which may have been dug by him. The above rules shall be incorporated in the contracts and in notices inviting tenders and shall form an integral part of the contracts.

2. AMENDMENTS:

Government may, from time to time, add to or amend these rules and issue directions – it may consider necessary for the purpose of removing any difficulty which may arise in the administration thereof.

DEVELOPER'S LABOUR REGULATIONS

**** SHORT TITLE:**

These regulations may be called the Developer Labour Regulations.

**** DEFINITIONS:**

Workman means any person employed by SMC or its developer directly or indirectly through a sub-developer with or without the knowledge of the SMC to do any skilled, semiskilled or unskilled manual, supervisory, technical or clerical work for hire or reward, whether the terms of employment are expressed or implied but does not include any person: Who is employed mainly in a managerial or administrative capacity: or Who, being employed in a supervisory capacity draws wages exceeding five hundred rupees per mensem or exercise either by the nature of the duties attached to the office or by reason of powers vested in him, functions mainly of managerial nature: or. Who is an out worker, that is to say, person to whom any article or materials are given out by or on behalf of the principle employers to be made up cleaned, washed, altered, ornamental finished, repaired adopted or otherwise processed for sale for the purpose of the trade or business of the principal employers and the process is to be carried out either in the home of the out worker or in some other premises, not being premises under the control and management of the principal employer. No person below the age 14 years shall be employed to act as workmen. Fair Wages means wages whether for time or piecework fixed and notified under the provisions of the

Minimum Wages Act from time to time. Developers shall include every person who undertakes to produce a given result other than a mere supply of goods or articles of manufacture through contract labour or who supplies contract labour for any work and includes a sub-developer. Wages shall have the same meaning as defined in the Payment of Wages Act. Normally working hours of an adult employee should not exceed 9 hours a day. The working day shall be so arranged that inclusive of interval for rest, if any, it shall not spread over more than 12 hours on any day.

When an adult worker is made to work for more than 9 hours on any day or for more than 48 hours in any week, he shall be paid over time for the extra hours put in by him at double the ordinary rate of wages.

Every worker shall be given a weekly holiday normally on a Sunday, in accordance with the provisions of the Minimum Wages (Central) Rules 1960 as amended from time to time irrespective of whether such worker is governed by the Minimum Wages Act or not.

Where the minimum wages prescribed by the Government under Minimum Wages Act are not inclusive of the Wages for the weekly day of rest, the workers shall be entitled to rest day wages at the rate applicable to the next preceding day provided he has worked under the same developer for a continuous period of not less than 6 days.

Where a developer is permitted by the Engineer-in-Charge to allow a worker to work on a normal weekly holiday, he shall grant a substituted holiday to him for the whole days on one of the five days immediately before or after the normal weekly holiday and pay wages to such worker for the work performed on the normal weekly holiday at overtime rate.

DISPLAY OF NOTICE REGARDING WAGES ETC: The developer shall before he commences his work on contract, display and correctly maintain and continue to display and correctly maintain in a clear and legible condition in conspicuous places on the work, notices in English and in the local Indian languages spoken by the majority of the workers giving the minimum rates of wages fixed under Minimum Wages Act, the actual wages being paid, the hours of work for which such wages are earned, wages periods, dates of payments of wages and other relevant information as per Appendix 'III'

PAYMENT OF WAGES: The developer shall fix wages period in respect of which wages shall be payable. No wages period shall exceed one month. The wages of every person employed as contract labour in an establishment or by a developer where less than one thousand such persons are employed shall be paid before the expiry of seventh day and in other cases before the expiry of tenth day after the last day of the wage period in respect of which the wages are payable. Where the employment of any worker is terminated by or on behalf of the developer the wages earned by him shall be paid before the expiry of the second

Working day from the date on which his employment is terminated. All payment of wages shall be made on working day at the work premises and during the working time and on a date notified in advance and in case the work is completed before the expiry of the wages period, final payment shall be made within 48 hours of the last working day. Wages due to every worker shall be paid to him direct or to other person authorized by him in this behalf. All wages shall be paid in current coin or currency or in both. Wages shall be paid without any deductions of any kind except those specified by the Central Government by general or special order in this behalf or permissible under the Payment of Wages Act 1956. A notice showing the wages period and the place and time of disbursement of wages shall be displayed at the place of work and a copy sent by the developer to the Engineer-in-Charge under acknowledgement. It shall be the duty of the developer to ensure the disbursement of wages in the presence of the Junior Engineer or any other authorized representative of the Engineer-in-charge who will be required to be present at the place and time

of disbursement of wages by the developer to workmen. The developer shall obtain from the Junior Engineer or any other authorized representative of the Engineer-in-Charge as the case may be certificate under his signature at the end of the entries in the "Register of Wages" or the "wages-cum-Muster Roll" as the case may be in the following form: Certified that the amount shown in column No. _____ has been paid to the workman concerned in my presence on _____ at _____

6. FINES AND DEDUCTIONS WHICH MAY BE MADE FROM WAGES:

- The wages of a worker shall be paid to him without any deduction of any kind except the following
 - Fines
 - Deductions for absence from duty i.e. from the place or the places where by the terms of his employment he is required to work. The amount of deduction shall be in proportion to the period or which he was absent.
 - Deduction for damage to or loss of goods expressly entrusted to the employed person for custody, or for loss of money or any other deduction which he is required to account, where such damage or loss is directly attributable to his neglect or default.
 - Deduction for recovery of advance or for adjustment of overpayment of wages, advances granted shall be entered in a register.
 - Any other deduction which the Central Government may from time to time No fines should be imposed on any worker save in respect of such acts and omissions on his part as have been approved of by the Chief Labour Commissioner.
 -

Note: An approved list of Acts and Omission for which fines can be imposed is enclosed at Appendix-I.

- No fine shall be imposed on a worker and no deduction for damage or loss shall be made from his wages until the worker has been given an opportunity of showing cause against such fines or deductions.
- The total amount of fine which may imposed in any one wages period on a worker shall not exceed an amount equal to three paise in a rupee of the total wages, payable to him in respect of that wage period.
- No fine imposed on any worker shall be recovered from him by installment, or after the expiry of sixty days from the date on which it was imposed.
- Every fine shall be deemed to have been imposed on the day of the act or omission in respect of which it was imposed.

LABOUR RECORDS: The developer shall maintain a "Register of persons employed" on work on contract in Form XIII of the CL(R&A) Central Rules 1971(Appendix IV). The developer shall maintain a "Muster Roll register" in respect of all workmen employed by him on the work under Contract in Form XVI of the CL(A&A) Rules 1971(Appendix V). The developer shall maintain a "Wages Register" in respect of all workmen employed by him on the work under contract in Form XVII of the CL(R&A) Rules 1971 (Appendix VI). Register of accident The developer shall maintain a register of accidents in such form as may be convenient at work place but the same shall include the following particulars:

- Full particulars of the labourers who met with accident
- Rate of Wages

- Sex
 - Age
 - nature of accident and cause of accident
 - Time and date of accident
 - Date and time when admitted in Hospital
 - Date of discharge from the Hospital
 - Period of treatment and result of treatment
 - Percentage of loss of earning capacity and disability as assessed by Medical Officer
 - Claim required to be paid under Workmen's Compensation Act
 - Date of payment of compensation
 - Amount paid with details of the person to whom the same was paid
 - Authority by whom the compensations was assessed
 - Remarks.
- The developer shall maintain a Register of Fines in the Form XII of the CL(R&A) rules 1971 (Appendix-XI).
 - The developer shall display in good condition and in a conspicuous place of work the approved list of acts and omissions for which fines can be imposed (Appendix-X).
 - The developer shall maintain a "Register of deductions" for damage or loss" in Form XX of the CL(R&A) rules 1971 (Appendix- XII).
 - The developer shall maintain a "Register of Advance" in Form XXIII of the CL(R&A) rules 1971 (Appendix- XIII).
 - The developer shall maintain a "Register of Overtime" in Form XXIII of the CL(R&A) rules 1971 (Appendix- XIV).

ATTENDANCE CARD-CUM WAGE SLIP:

- i. The developer shall issue an "Attendance card-cum-wag slip" to each workman employed by him in the specimen from at (Appendix-VII).
- ii. The card shall be valid for each wage period.
- iii. The developer shall mark the attendance of each workman on the card twice each day, once at the commencement of the day and again after the rest interval, before he actually starts work.
- iv. The card shall remain in possession of the worker during the wage period under reference.
- v. The developer shall complete the wage slip portion on the reverse of the card at least a day prior to the disbursement of wages in respect of the wage period under reference.
- vi. The developer shall obtain the signature or thumb impression of the worker on the wage slip at time of disbursement of wage and retain the card with himself.

EMPLOYMENT CARD: The developer shall an "Employment Card" in Form XIV of the CL(R&A) Central Rules 1971 to each worker within three days of the employment of the worker (Appendix VIII). SERVICE CERTIFICATE: On termination of employment for any reason whatsoever the developer shall issue to the workman whose services have been terminated, a Service certificate in Form XV of the CL(R&A) Central Rules 1971 (Appendix- IX). PRERSERVATION OF LABOUR RECORDS EMPLOYMENT CARD: All record required to be maintained under Regulation Nos. 6 &7 shall be preserved in original for a period of three years from the date of last entries made in them and shall be made available for inspection by the Engineer-in-Charge of Labour Officer or any other officers authorized by the Ministry of Urban Development in this behalf. POWER OF LABOUR OFFICER TO MAKE INVESTIGATIONS OR ENQUIRY: The labour Officer or any person authorized by Central Government on their behalf shall have power to make enquires with a view to ascertaining and enforcing due and proper observance of Fair Wages Clause and the Provisions of these Regulations. He shall investigate into any complaint regarding the default made by the developer or sub-developer in regard to such provision. REPORT OF LABOUR OFFICER: The Labour Officer or other persons authorized shall submit a report of result of his investigation or enquiry to the Executive Engineer concerned indicating the extent, if any, to which the default has been committed with a note that necessary deductions from the developer's bill be made and the wages and other dues be paid to the labourers concerned. In case an appeal is made by the developer under Clause 13 of these regulations, actual payment to labourers will be made by the Executive Engineer after the Superintending Engineer has given his decision on such appeal.

- i. The Executive Engineer shall arrange payments to the labour concerned within 45 days from the receipt of the report from the Labour Officer or the Superintending Engineer as the case may be.

APPEAL AGAINST THE DECISION OF LABOUR OFFICER: Any person aggrieved by the decision and recommendations of the Labour Officer or other person so authorized may appeal against such decision to the Superintending Engineer concerned to the Executive Engineer concerned but subject to such appeal, the decision of the officer shall be final and binding upon the developer.

PROHIBITION REGARDING REPRESENTATION THROUGH LAWYER:

- ii. A workman shall be entitled to be represented in any investigation or enquiry under these regulations by:
 - a An officer of a registered trade union of which he is a member.
 - b An officer of a federation of trade unions to which the trade union referred to in clause (a) is affiliated.
 - c Where the employer is not a member of any registered trade union, by an officer of a registered trade union, connected with the industry in which the worker is employed or by any other workman employed in the industry in which the worker is employed.
- iii. An employer shall be entitled to be represented in any investigation or enquiry under these regulations by:
 3. An officer of an association of employers of which he is a member.

4. An officer of a federation of associations of employers to which association referred to in clause (a) is affiliated.
5. Where the employers is not a member of any association of employers, by an officer of association of employer connected with the industry in which the employer is engaged or by any other employer, engaged in the industry in which the employers is engaged.

INSPECTION OF BOOKS AND SLIPS: The developer shall allow inspection of all the prescribed labour records to any of this workers or to his agent at a convenient time and place after due notice is received or to the Labour Officer or any other person, authorized by the Central Government on his behalf. SUBMISSION OF RETURNS: The developer shall submit periodical returns as may be specified from time to time. AMENDMENTS: The Central Government may from time to time add to or amend the regulations and on any questions as to the applicable/ interpretation or effect of those regulations the decision of the Superintending Engineer Concerned shall be final.

INSURANCE & INDEMNITIES: Following is the indicative list of Insurances, which a contractor/developer is supposed to take: Indemnity and insurance against damage to structure or decorative work: The Contractor/developer shall insure in joint names of the Owner and the Contractor/developer, against all loss or damage during the transit, storage and execution or installation and commissioning from Whatever cause arising, for which he is responsible under the terms of Contract, **including “CAR” Policy. Indemnity and insurance against injury or accident to workmen:** The Owner shall not be liable for or in respect of any damage or compensation payable at law in respect or in consequences of any accident or injury to any workmen or other person in the employment of the Contractor/developer or any Sub-Contractor/developer. The Contractor/developer shall indemnify and keep indemnified the Owner against all such damages and compensations and against all claims, proceedings, costs, charges and expenses, whatsoever, in respect thereof or in relation thereto. The Contractor/developer shall ensure against such liability and obtain Workmen’s Compensation Policy with an insurer approved by the Owner and shall continue such insurance during the whole of the time that any person employed by him as on the Works. **Indemnity and Insurance against damaged Property:** Before commencing the execution of the Works, the Contractor/developer shall insure against his liability for any material or physical damage, loss or injury, which may occur to any property including that of the Owner, and to any person including any employee of the Owner/Consultant, by or arising out of the execution of the Works or in the carrying out of the Contract. **Insurance against Fire, Theft, Etc.:** The building works (including materials of site, temporary building, tools, plant etc.) shall be from the commencement of the works until the time the possession of the building is taken over or given to the owner, be in the sole charge of the contractor/developer who will be responsible for and will, with all possible speed, make good at his expense, all damage caused thereon thereto by accident, bad foundations, whether, frost, tempest, fire, theft, riot or other causes whatsoever.

Insurance Generally: The terms of the insurance policies shall include a provision whereby, in the event of any claim in respect of which the Contractor/developer would be entitled to receive, indemnify under the policy being brought or made against the Owner, the insurer will indemnify the Owner against such claims and any costs charges and expenses in respect thereof. The insurance policies shall provide that they shall not be cancelled till the Owner has agreed to their cancellation. The Contractor/developer shall provide Owner and the ARCHITECT with a copy of each of the insurance policies and documents taken out of by him in pursuance of the Contract immediately

after such insurance coverage. If the Contractor/developer shall fail to effect and keep in force insurance, as per the terms of Contract, the Owner may effect and keep in force any such insurance and pay such premium or premiums as any be necessary for that purpose and from time to time deduct the amount so paid by the Owner as aforesaid from any monies due or which may become due to the Contractor/developer, or recover the same as debit due from the Contractor/developer. The Contractor/developer shall be responsible for preparing all claims and make good for all damage or loss by way of repairs and/or replacement of portion of any Works damaged or lost. The transfer of title shall not in any way relieve the Contractor/developer of his responsibilities during the period of the Contract including the defects Liability period.

Appendix 1: Register of Maternity Benefits

Name and address of the contractor/developer:

Name and location of the work:

Name of the Employee	Father's/Husband's Name	Nature of Employment	Period of Actual Employment	Date of which notice of confinement given
<u>1</u>	<u>2</u>	<u>3</u>	<u>4</u>	<u>5</u>

Date on which maternity leave commenced and ended				
Date of Delivery/ Miscarriage	In case of delivery		In case of miscarriage	
	Commenced	Ended	Commenced	Ended

6	7	8	9	10
Leave pay paid to the employee				
In case of delivery		In case of miscarriage		Remarks
Rate of leave pay	Amount paid	Rate of leave pay	Amount paid	
11	12	13	14	15

Signature Of Bidder

Appendix 2:

SPECIMEN FORM OF THE REGISTER, REGARDING MATERNITY BENEFIT ADMISSIBLE TO THE CONTRACTOR/DEVELOPER'S LABOUR Name and address of the contractor/developer: Name and location of the work:

1. Name of the woman and her husband's name
2. Designation
3. Date of appointment
4. Date with months and years in which she is employed
5. Date of discharge/ dismissal, if any
6. Date of production of certificates in respect of pregnancy
7. Date on which the woman informs about the expected delivery
8. Date of delivery/miscarriage/death
9. Date of production of certificate in respect of delivery/ miscarriage
10. Date with amount of subsequent payment of maternity benefit
11. Dare with amount of subsequent payment of maternity benefit

12. Name of the person nominated by the woman they receive the payment of the maternity benefit after her death

13. If the woman dies, the date of her death, the name of the person to whom maternity benefit amount was paid, the month thereof and the date of payment

14. Signature of the contractor/developer authenticating entries in the register

15. Remarks column for the use if Inspecting Officer

Signature Of Bidder

Appendix 3: LABOUR BOARD

Name and work:

Name of Contractor/developer: Address of Contractor/developer:

Name and address of Division:

Name of Labour Officer:

Address of Labour Officer:

Name of Labour Enforcement Officer:

Address of Labour Enforcement Officer

Sr NO	Category	Minimum Wages Fixed	Actual wages Paid	Number Present	Remarks
1	2	3	4	5	6

Weekly holiday:

Wages period:

Date of payment of wages:

Working hours:

Rest interval:

Signature Of Bidder

Appendix 4:

REGISTER OF WORKMEN EMPLOYED BY CONTRACTOR/DEVELOPER

Name and address of contractor/developer:

Name and address of establishment under which contract is carried on:

Nature and location of work:

Name and address of Principal Employer

Sr no	Name and surname of workman	Age and sex	Age and sex	Father' Husband' s name	Nature of employment /designation	Permanent home Address of the workman(Village and Tehsil, taluk and Districts)	Local address	Date of commencement of employment	Signature or thumb impression of the workman	Reasons for terminations	Remarks
1	2	3	4	5	6	7	8	9	10	11	12

Signature Of Bidder

Appendix 5:

MUSTER ROLL

Name and address of contractor/developer:

Name and address of establishment under which contract is carried on:

Nature and location of work:

Name and address of Principal Employer _____ for the Month of _____

S.No.	Name of Workman	sex	Father's/ Husband's name	Date					Remark
				<u>i</u>	<u>ii</u>	<u>iii</u>	<u>iv</u>	<u>v</u>	
<u>1</u>	<u>2</u>	<u>3</u>	<u>4</u>						<u>6</u>
				<u>i</u>	<u>ii</u>	<u>iii</u>	<u>iv</u>	<u>v</u>	

Signature Of Bidder

Appendix 6:

REGISTER OF WAGES

Name and address of contractor/developer:

Name and address of establishment under which contract is carried on:

Nature and location of work:

Sr. No	Name of workman	Serial no. in the register of workman	Designation/nature of work done	No. of days worked	Units of work done	Daily rate of wages/ piece rate	Basic wages	Dearness allowances	Over time	Other cash payments (indicate nature)	Total	Deductions if any, (indicate nature)	Net amount paid	Signature or thumb impression of the workman	Initial of contractor or his representative
<u>1</u>	<u>2</u>	<u>3</u>	<u>4</u>	<u>5</u>	<u>6</u>	<u>7</u>	<u>8</u>	<u>9</u>	<u>10</u>	<u>11</u>	<u>12</u>	<u>13</u>	<u>14</u>	<u>15</u>	<u>16</u>

Name and address of Principal Employer:

Wages Period: Monthly/ Fortnightly

Signature Of Bidder

Appendix 7:

Wage Card

Wage Card No.

Name and address of contractor/developer:

Date of Issue:

Name and location of work:

Designation:

Name of workman:

Month/Fortnight:

Rate of Wages:

Received from _____ the sum of INR _____ on account of my wages

	1	2	3	4	5	6	7	8	9	10	11	12	13	14	15	16	17	18	19	20	21	22	23	24	25	26	27	28	29	30	31
Morning																															

The Wage Card is valid for one month from the date of issue.

Signature Of Bidder

Appendix 8:

Wage Slip

Name and address of contractor/developer:

Name and Father's/ Husband's name of workman:

Nature and location of work:

The Week/ Fortnight/Month ending:

- No. of days worked:
- No. of units worked in case of piece rate workers:
- Rate of daily wages/piece rate:
- Amount of overtime wages:
- Gross wages payable:
- Deduction, if any:
- Net amount of wages paid:

Signature Of Bidder

Initials of the Contractor/developer or his representative

Appendix 9:

Employment Card

Name and address of contractor/developer:

Name and address of establishment in/under which contract is carried on:

Name of work and location of work:

Name and address of Principal Employer:

1. Name of the workman:
2. S. No. in the register of workman employed:
3. Name of employment/designation:
4. Wage rate (with particulars of unit in case of piece work):
5. Wage period:
6. Tenure of employment:
7. Remarks:

Signature of Contractor/developer

Appendix 10: Service Certificate

Name and address of contractor/developer:

Name and location of work:

Name and address of workman:

Age or date of birth:

Identification marks: Father's / Husband's name:

Name and address of establishment in under which contract is carried on:

Name and address of Principal Employer:

Sr. No.	Total period for which employed		Nature of Work Done	Rate of Wages (with particulars of unit in case of piece work)	Remarks
	From	To			
1	2	3	4	5	6

Signature Of Bidder

Appendix 11:

LIST OF ACTS AND OMISSIONS FOR WHICH FINES CAN BE IMPOSED

In accordance with rule 7 (v), Contractor/developer's Labour Regulations to be displayed prominently at the site of work both in English and local Language. 1. Willful insubordination or disobediences, whether along or in combination with order. 2. Theft fraud or dishonesty in connection with the contractor/developers beside a business or property of GHB. 3. Taking or giving bribes or any illegal gratifications. 4. Habitual late attendance. 5. Drunkenness lighting, riotous or disorderly or indifferent behavior. 6. Habitual negligence. 7. Smoking near or around the area where combustible or other materials are locked. 8. Habitual indiscipline. 9. Causing damage to work in the progress or to property of the GHB or of the contractor/developer. 10. Sleeping on duty. 11. Malingering or slowing down work. 12. Giving of false information regarding name, age father's name, etc. 13. Habitual loss of wage cards supplied by the employers. 14. Unauthorized use of employer's property of manufacturing or making of unauthorized particles at the work place. 15. Bad workman ship in construction and maintenance by skilled workers which is not approved by the Department and for which the contractor/developers are compelled to undertake rectifications. 16. Making false complaints and/ or misleading statements. 17. Engaging on trade within the premises of the establishments. 18. Any unauthorized divulgence of business affairs of the employees. Collection or canvassing for the collection of any money within the premises of an establishment unless authorized by the employer. 20. Holding meeting inside the premises without previous sanction of the employers. 21. Threatening or intimidating any workman or employer during the working hours within the premises.

Appendix 12:

REGISTER OF FINES

Name and address of contractor/developer:

Name and address of establishment in under which contract is carried on:

Nature and location of work:

Name and address of Principal Employer:

Sr no	Name of workman	Father's / Husband's name	Designation/nature of employment	Act/omission for which fine imposed	Date of Offence	Whether workman showed cause against fine	Name of person in whose presence employee's explanation was heard	Wages period and wages payable	Amount of fine imposed	Date of which fine realized	Remarks
1	2	3	4	5	6	7	8	9	10	11	12

Signature Of Bidder

Appendix 13:

REGISTER OF DEDUCTION FOR DAMAGE OR LOSS

Name and address of contractor/developer:

Name and address of establishment in under which contract is carried on:

Nature and location of work:

Name and address of Principal Employer:

Date of recovery

Sr no	Name of workman	Father's / Husband's name	Designation/nature of employment	Particulars of damage and loss	Date of Damage and loss	Whether workman shows cause against deduction	Name of person in whose presence employee's explanation was heard	Amount of deduction imposed	No. of installments	First installment	Last installment	Remarks
1	2	3	4	5	6	7	8	9	10	11	12	13

Signature Of Bidder

Appendix 14:

REGISTER OF ADVANCES

Name and address of contractor/developer:

Name and address of establishment in under which contract is carried on:

Nature and location of work:

Name and address of Principal Employer: .

Sr no	Name of workman	Father's / Husband's name	Designation/nature of employment	Wages period and wages payable	Date and amount of advance given	Purpose(s) for which advance made	Number of installments by which advance to be repaid	Date of amount of each installment was repaid	Date on which last installment was repaid	Remark
1	2	3	4	5	6	7	8	9	10	11

Signature Of Bidder

Appendix 15:

REGISTER OF OVERTIME

Name and address of contractor/developer:

Name and address of establishment in under which contract is carried on:

Nature and location of work:

Name and address of Principal Employer:

Sr no	Name of workman	Father's / Husband's name	sex	Designation /nature of employment	Date on which Overtime worked	Total overtime worked or production in case of piece rated	Normal rate of wages	Overtime rate of wages	Overtime rate of wages	Rate on which overtime wages paid	Remarks
1	2	3	4	5	6	7	8	9	10	11	12

Signature Of Bidder

Appendix 16:

NOTICE FOR APPOINTMENT OF ARBITRATOR

To

**The Executive Engineer,
Slum Upgradation Department,
Surat Municipal Corporation,
2nd floor, Old Rander,
Zone Office, Tadwadi,
Surat**

Dear Sir,

In terms of Clause 23 of the agreement, particulars of which given below, I/we hereby give notice to you to appoint arbitrator for settlement of dispute mentioned below:

1. Name of applicant
2. Whether applicant is individual/ Prop. Firm/Partnership Firm/Ltd.Co.
3. Full address of applicant
4. Name of the work and contract number in which arbitration sought
5. Name of the Division which entered into contract
6. Contract amount in the work
7. Date of Contract
8. Date of initiation of work
9. Stipulated date of completion of work
10. Actual date of completion of work (if completed)
11. Total number of claims made
12. Total amount claimed
13. Date of intimation of final bill(if work is completed)
14. Date of payment of final bill (if work is completed)
15. Amount of final bill(if work is completed) p Date of request made to SE for decision
16. Date of receipt of SE's decision.
17. Date of appeal to you
18. Date of receipt of your decision. Specimen signature of the applicant

I/we certify that the information given above is true to the best of my/our knowledge and believe.

I/we enclosed following documents 1. Statement of claims with amount of claims Yours faithfully,
(Signature) (Only the person/ authority who signed the contract should sign)

Signature Of Bidder

Instruction to Bidders

- **GOG Planning Regulation Guidelines**
- **GOG Policy**
- **Amendment**

Sketch of CC road and Paver block are also attached here with; Bidders are requested to download the guideline documents as described.

મુખ્ય મંત્રી ગૃહ (Gujarat Rural Urban Housing)
યોજના અંતર્ગત જાહેર જમીનો પર આવેલ
ઝૂંપડપટ્ટીઓનું PPP(પબ્લિક પ્રાઇવેટ પાર્ટનરશીપ)
ધ્વારા તે જ સ્થળે પુનઃવસન કરવા માટેની નીતિ

ગુજરાત સરકાર
શહેરી વિકાસ અને શહેરી ગૃહનિર્માણ વિભાગ,
ઠરાવ ક્રમાંક: પીઆરસી/૧૦૨૦૧૩/૭૮૩/થ
સચિવાલય, ગાંધીનગર.
તારીખ- ૧૮ /૭/૨૦૧૩

સંદર્ભ:-

(૧) શહેરી વિકાસ અને શહેરી ગૃહનિર્માણ વિભાગ, સચિવાલય, ગાંધીનગર ના તા.૪/૩/૨૦૧૦ હુકમ
ક્રમાંક: પરચ/૧૦-૨૦૦૯/૩૫૭૨/લ.

આમુખ:-

ઝૂંપડાવાસીઓના પુનઃ વસન અને પુનઃ વિકાસ માટેના વિનિયમો-૨૦૧૦ અંતર્ગત સંદર્ભ-(૧) ના હુકમથી નીતિ નક્કી કરવામાં આવેલ હતી. આ નીતિમાં ફેરફાર કરવાની બાબત રાજ્ય સરકારની વિચારણા હેઠળ હતી. શહેરી ગુજરાતને ઝૂંપડપટ્ટી મુક્ત બનાવવાનો સંકલ્પ કેન્દ્રમાં રાખી ગુજરાત સરકાર ધ્વારા નાણાંકીય વર્ષ ૨૦૧૩-૧૪માં ૧૨મી પંચવર્ષિય યોજના દરમિયાન મુખ્ય મંત્રી ગૃહ (Gujarat Rural Urban Housing) યોજનાની જાહેરાત કરવામાં આવી છે. શહેરી વિસ્તારમાં અંદાજિત જે સાત લાખ કુટુંબો ઝૂંપડાઓમાં વસે છે તેઓનું તે જ સ્થળે પુનઃવસન કરવાની નીતિને અગ્રતા આપવાની રાજ્ય સરકારની નેમ છે. ૭ લાખ ઝૂંપડાવાસી કુટુંબોને લઘુત્તમ ૨૫ ચો.મી. સુધીના કારપેટ વિસ્તાર અને તમામ મૂળભૂત સુવિધાઓવાળા મકાનો મફતમાં ઉપલબ્ધ કરાવવા અંગેની નીતિ ધ્વારા રાજ્ય સરકારનું પ્રયોજન નીચે મુજબના ધ્યેય સિધ્ધ કરવાનું છે.

૧. રાજ્યના શહેરી વિસ્તારોમાં આવેલી ઝૂંપડપટ્ટીઓનું પુનઃસ્થાપન તે જ સ્થળે (In - Situ) કરવું
૨. ઝૂંપડપટ્ટીમાં વસતા કુટુંબોને પ્રાથમિક સુવિધાઓ સાથેના બે રૂમ, રસોડું, બાથરૂમ અને જાજરૂવાળું મકાન ઉપલબ્ધ કરાવવું.
૩. ૧૫ વર્ષ પછી લાભાર્થીને આ મકાનનો માલિકી હકક આપવો.

૪. શહેરી ગરીબોની જીવનશૈલી સ્વચ્છ અને સ્વાસ્થ્યપ્રદ બનાવવી.
૫. રાજ્યના શહેરોના સામાજિક, આર્થિક અને પર્યાવરણમાં ગુણાત્મક સુધાર કરવો.
૬. આ હેતુ માટે “પબ્લિક પ્રાઇવેટ પાર્ટનરશીપ” ધ્વારા ખાનગી મૂડી રોકાણને આકર્ષવું.
૭. હાલના હયાત સ્થળે (In - Situ) પુનઃવસન માટે સરળ અને પારદર્શક નીતિના માળખાનું ઘડતર કરવું.

ઠરાવ:-

ગુજરાત ગંદા વસવાટ વિસ્તાર (સુધારણા, નાબૂદી અને પુનઃવિકાસ) અધિનિયમ, ૧૯૭૩ની કલમ-૫૮ (૨) (ઘ) હેઠળ પ્રાપ્ત થયેલ સત્તાને અનુલક્ષીને રાજ્ય સરકાર ધ્વારા નીચે મુજબની જાહેર જમીન પર આવેલ ઝૂંપડપટ્ટીઓનું ખાનગી વિકાસકારની ભાગીદારીથી પુનઃવસન નીતિને અનુસરવાનું આથી ઠરાવવામાં આવે છે.

૧. ઝૂંપડપટ્ટી (ગંદા વસવાટ વિસ્તાર)- આ નીતિ અંતર્ગત નિયત કરેલ સત્તા મંડળને એવી ખાતરી થાય કે -
 - (ક) કોઇ વિસ્તાર નીચાણવાળો, અસ્વચ્છ, ગંદો, ગીચોગીચ હોવાને લીધે અથવા અન્યથા તે વિસ્તારના અથવા તેની પડોશના રહેવાસીઓના આરોગ્ય, સલામતી અથવા નીતિમત્તાને તે ભયરૂપ છે, અથવા
 - (ખ) માનવ વસવાટ માટે વપરાતા અથવા વાપરવા ધારેલા કોઇ વિસ્તારમાંના મકાનો-
 - (૧) માનવ વસવાટ માટે કોઇ પણ રીતે અયોગ્ય છે, અથવા
 - (૨) આવા મકાનોની બિસ્માર હાલત, ગીચતા, ખામી ભરેલી ગોઠવણી અને રચનાને કારણે, રસ્તાની સંકડાશ અથવા ખામી ભરેલી ગોઠવણીને કારણે, હવા-ઉજાસ, પ્રકાશ અથવા સફાઇ સગવડના અભાવને અથવા આ બધા કારણે સલામતી, આરોગ્ય અથવા નીતિમત્તાને હાનિકારક છે, ત્યારે તે, રાજપત્રમાં જાહેરનામું પ્રસિધ્ધ કરીને, આવા વિસ્તારને ઝૂંપડપટ્ટી (ગંદા વસવાટના વિસ્તાર) તરીકે જાહેર કરી શકશે.
 - (ગ) કોઇ મકાન આ અધિનિયમના હેતુઓ માટે, માનવ વસવાટ માટે અયોગ્ય છે કે કેમ તે નક્કી કરતી વેળા, નીચેની બાબતોના સંબંધમાં તેની હાલત લક્ષમાં લેવી જોઇશે:-
 - (૧) મરામત,
 - (૨) મજબૂતી,
 - (૩) ભેજ વગરની સ્થિતિ,
 - (૪) કુદરતી હવા ઉજાસ,
 - (૫) પાણીની સગવડ,
 - (૬) ગટર અને સફાઇની સગવડો,

(૭) અનાજ ભરવા, ખોરાક તૈયાર કરવા અને રાંધવા માટે અને ગંદા પાણીના નિકાલ માટેની સગવડો, અને સદરહુ બાબતો પૈકી એક અથવા વધુ બાબતમાં મકાન એવી ખામીવાળુ હોય કે, તે હાલતનું મકાન રહેવા માટે વાજબી રીતે યોગ્ય નથી તો તે મકાન ઉપર જણાવ્યા મુજબ અયોગ્ય ગણાશે.

૨. વ્યાપ્તિ અને આરંભ:-

આ નીતિ જાહેર જમીનો પર આવેલ ઝૂંપડપટ્ટીઓ માટે લાગુપાડી શકાશે. જાહેર જમીનો અંતર્ગત સરકારી જમીનો, શહેરી જમીન ટોચ મર્યાદા ધારા અંતર્ગત છુટી કરવામાં આવેલ જમીનો, શહેરી સ્થાનિક સ્વરાજ્યની સંસ્થાઓ, શહેરી વિકાસ સત્તા મંડળો, જાહેર બોર્ડ, સાહસો તેમજ જાહેર સત્તા મંડળોની માલિકીની જમીનો આવરી લેવામાં આવશે. આ નીતિનો વ્યાપ ભવિષ્યમાં અન્ય જમીનો માટે પણ રાજ્ય સરકાર ઠરાવે તે રીતે વધારી શકાશે.

૩. રાજ્ય તેમજ શહેર કક્ષાએ સત્તા મંડળની સ્થાપના કરવામાં આવશે.

૩.૧ રાજ્ય કક્ષાએ ઝૂંપડપટ્ટી પુનઃવસન માટેના સત્તામંડળમાં ઓછામાં ઓછા ૧૨ સભ્યોનો સમાવેશ થશે.

૩.૨ રાજ્ય કક્ષાના ઝૂંપડપટ્ટી પુનઃવસન માટેના સત્તામંડળના કાર્યો અને સત્તાઓ;

૩.૨.૧ ઝૂંપડપટ્ટી પુનઃવસન સાથે સંકળાયેલા પ્રશ્નો અને મુદાઓના સંદર્ભમાં માસ્ટર પ્લાનીંગની પ્રક્રિયા, ટાઉન પ્લાનીંગ તેમજ જમીનના ઉપયોગ સાથે સંકળાયેલી બાબતો નક્કી કરવી અને / અથવા માર્ગદર્શન આપવું.

૩.૨.૨ ઝૂંપડપટ્ટી પુનઃવસનના સંદર્ભમાં યોજનાઓ અને કાર્યક્રમોનું ઘડતર કરવું. તેના અમલીકરણનું વિનિયમન કરવું.

૩.૨.૩ ઝૂંપડપટ્ટી પુનઃવસન યોજનાઓના સંદર્ભમાં તેના ઘડતર અને અમલીકરણ અંગે અર્થઘટન અને મુશ્કેલીઓનું નિવારણ કરવું.

૩.૨.૪ ગુજરાત રાજ્યના સમગ્ર શહેરી વિસ્તારો માટે નિયત કરેલ સત્તામંડળ તરીકેની સત્તાઓ અને કાર્યો જરૂરિયાત મુજબ કરવા.

૩.૨.૫. રાજ્યની વિધાનસભા સમક્ષ આ નીતિ અને કાર્યક્રમો અંગેનો વાર્ષિક અહેવાલ રજૂ કરવો.

3.3 મ્યુનિસિપલ કોર્પોરેશન તેમજ શહેરી વિકાસ સત્તા મંડળ કક્ષાએ ઝૂંપડપટ્ટીના પુનઃવસન માટે ઓછામાં ઓછા ૮ સભ્યો ધરાવતી સંયુક્ત નિયત સત્તા મંડળની રચના કરવામાં આવશે તેમજ નગરપાલિકાઓ તેમજ વિસ્તાર વિકાસ સત્તા મંડળ માટે સંયુક્ત સત્તા મંડળની રચના કરવામાં આવશે.

3.3.૧. નિયત સત્તામંડળને સોંપવામાં આવેલી સત્તાઓ, કાર્યો અને જવાબદારીઓ

3.3.૧.૧ ઝૂંપડપટ્ટી પુનઃવસન માટે શહેરી વિસ્તારોમાં આવેલા ઝૂંપડપટ્ટી વિસ્તારો અને જમીનોની પ્રાથમિક સ્થિતિનો અભ્યાસ કરવો, ઝૂંપડપટ્ટીમાં વસવાટ કરનાર કુટુંબોની યાદી બનાવવી અને તેની સમીક્ષા કરવી.

3.3.૧.૨ ઝૂંપડપટ્ટી વિસ્તારમાં આવેલા માનવ વસતીના વસવાટ માટે હાનિકારક હોય તેવા મકાનોને દૂર કરવા.

3.3.૧.૩ ઝૂંપડપટ્ટી વિસ્તારોનો પુનઃવિકાસ અને પુનઃવસન કરવું.

3.3.૧.૪ ઝૂંપડપટ્ટી વિસ્તારોમાં તે જ સ્થળે પુનઃવસન માટે યોજનાઓ ઘડવી.

3.3.૧.૫ ગુજરાત ગંદા વસવાટ વિસ્તાર અધિનિયમ, ૧૯૭૩ની કલમ ૫૬ (૧) માં પ્રાપ્ત સત્તા અન્વયે રાજ્ય સરકાર ધ્વારા કલમ (૧૧) મુજબ કોઈ પણ ઝૂંપડપટ્ટી વિસ્તારને ઝૂંપડપટ્ટી નાબૂદી વિસ્તાર જાહેર કરવાની સત્તા સંબંધિત નિયત સત્તામંડળને સોંપવામાં આવશે.

3.3.૧.૬ ઝૂંપડપટ્ટી પુનઃવસન યોજનાનું અમલીકરણ કરવું.

3.3.૧.૭ ગ્રાઉન્ડ ફ્લોર ઉપર પાર્કિંગની વ્યવસ્થા રાખવાની રહેશે.

3.3.૧.૮ ઝૂંપડપટ્ટીમાં રહેતા લાભાર્થીઓના એસોસિએશન અથવા સોસાયટીની રચનામાં સહાયક તરીકેની ભૂમિકા ભજવવી.

3.3.૧.૯ ઝૂંપડપટ્ટી પુનઃવસન યોજનાઓ અને વખતો-વખત નિયત કરવામાં આવે તેવા લાભો અને અમલીકરણના પરિપ્રેક્ષ્યમાં ખાનગી ક્ષેત્ર, ઝૂંપડપટ્ટી વિસ્તારના સમાજ સમુહો અને સ્વયંસેવી સંસ્થાઓ સાથે ભાગીદારી કરવી.

3.3.૧.૧૦ ઝૂંપડપટ્ટી પુનઃવસનના હેતુ માટેની ગૃપ હાઉસિંગ યોજનાઓ / સહકારી હાઉસિંગ યોજનાઓનું અમલીકરણ કરવું.

- 3.3.1.11 યોજનાના ઝડપી અમલીકરણ અને તેની કાર્યપ્રણાલીને પૂરક બનવાના હેતુથી સંબંધિત સત્તામંડળના સભ્યશ્રીઓ અને તજજ્ઞોની સેવાઓ લેવા માટે તેઓની સમિતિનું ગઠન કરી શકશે.
- 3.3.1.12 સત્તામંડળ તેની પ્રવૃત્તિઓની સંપૂર્ણ વિગતો અને અમલીકરણની સ્થિતિ સાથેનો વિગતવાર વાર્ષિક અહેવાલ તૈયાર કરી રજૂ કરશે.
- 3.3.1.13 નિયત કરવામાં આવે તેવા હિસાબો આ સત્તામંડળ જાળવશે.
- 3.3.1.14 ઝૂંપડપટ્ટી પુનઃવસન સંબંધિ વિવિધ યોજનાઓ અને કાર્યક્રમોનો સમયબદ્ધ રીતે, જવાબદારીપૂર્વક, નક્કી કરેલ બજેટમાં ગુણવત્તાના ધોરણો જાળવાઈ રહે તે હેતુસર અસરકારક નિયમન અને દેખરેખ કરવું.
- 3.3.1.15 અધિનિયમની કલમ- ૫૬ (૧) અંતર્ગત પ્રાપ્ત સત્તા અન્વયે કલમ ૩ (૧) મુજબ શહેરી વિસ્તારમાં ઝૂંપડપટ્ટી પુનઃવસનના હેતુસર ઝૂંપડપટ્ટી નિવાસીઓએ કબ્જો કરેલ વિસ્તારને ઝૂંપડપટ્ટી વિસ્તાર તરીકે (ગંદા વસવાટ વિસ્તાર તરીકે) જાહેર કરવાની સત્તા રાજ્ય સરકાર ધ્વારા નિયત સત્તા મંડળને સોંપવામાં આવશે.

૪. લાભાર્થીઓને મળવાપાત્ર લાભ :-

- ૪.૧ આ નીતિ અંતર્ગત લાભાર્થી તરીકે જે કુટુંબો તા.૧-૧૨-૨૦૧૦ના રોજ ઝૂંપડપટ્ટીમાં રહેતા હોય તેઓને ગણવામાં આવશે. અમલીકરણ એન્જસી ધ્વારા રીહેબીલીટીશન માટે ઇલેક્ટ્રીસીટી બિલ, મતદાર ઓળખ કાર્ડ, સ્લમ સર્વે અથવા રેશનકાર્ડ આ ચાર પૈકી કોઈ પણ બે માપદંડ આધારે લાભાર્થીઓની યાદી તૈયાર કરવાની રહેશે.
- ૪.૨ આ નીતિ અંતર્ગત ઝૂંપડપટ્ટીમાં રહેતા લાભાર્થીઓને તેઓના ઝૂંપડાના બદલે મફતમાં ઓછામાં ઓછું ૨૫ ચો.મી. બિલ્ટઅપ એરિયા ધરાવતું બે રુમ, ૨સોડું, બાથરૂમ તેમજ જાજરૂની સગવડવાળું પાકું મકાન આપવામાં આવશે.
- ૪.૩ લાભાર્થીઓને પીવાના પાણીની-ગટર લાઇનની તેમજ વિજળી કનેકશનની સવલતો આપવામાં આવશે. જેની કાયમી નિભાવણી, જાળવણી અને ચુકવવાપાત્ર ખર્ચની જવાબદારી લાભાર્થીની રહેશે. આ મકાનનો સ્થાનિક સ્વરાજ્યની સંસ્થાનો જે ધરવેરો અને ચુકવવાપાત્ર વેરો આવે તે લાભાર્થીએ નિયમિત ચુકવવાનો રહેશે.
- ૪.૪ આવા દરેક ૫૦૦ મકાન દીઠ ઓછામાં ઓછો ૫૦ ચો.મી. વિસ્તાર ધરાવતી આંગણવાડી / હેલ્થ સેન્ટરનો નિયમાનુસાર લાભ આપવામાં આવશે.

- ૪.૫ લાભાર્થીઓને ૧૫ વર્ષ માટે ફાળવવામાં આવેલ આવાસના લીઝ હોલ્ડ હકક આપવામાં આવશે અને ત્યાર બાદ માલિકી હકક આપવામાં આવશે. પરંતુ જમીનની માલિકી જે તે સ્થાનિક સ્વરાજની સંસ્થા અથવા સત્તા મંડળની રહેશે.
- ૪.૬ પુનઃવસનના હેતુસર ઝૂંપડપટ્ટીમાં વસતા લાભાર્થીને બે વિકલ્પો આપવામાં આવશે.
- ૪.૬.૧ હાલની જગ્યાએજ (In-Situ) ઝૂંપડપટ્ટી પુનઃવસન યોજનામાં મકાન મેળવવાના વિકલ્પો પ્રથમ તેમજ પસંદગી પાત્ર ગણવામાં આવશે.
- ૪.૬.૨ ફક્ત અપવાદરૂપ કિસ્સામાં જો કોઈ લાભાર્થી ઝૂંપડપટ્ટી પુનઃવસન યોજનાના ભાગરૂપે ઉપરોક્ત વિકલ્પને બદલે અન્ય કોઈ પણ ખાનગી પરવડે તેવી આવાસ યોજનામાં નિયત કરેલ લઘુત્તમ માપદંડો પ્રમાણેનું મકાન મેળવવા પોતાની ઇચ્છા અને લેખિત સંમતિથી વાજબી કારણો સાથે સંબંધિત સ્થાનિક સ્વરાજ્યની સંસ્થામાં રજૂઆત કરે અને તેની રજૂઆત માન્ય રહેથી આ વિકલ્પ મુજબ મકાન પુરું પાડવા સુધીની વ્યવસ્થા પસંદગી પામેલ વિકાસકારે જ કરવાની રહેશે.
- ૪.૭ ફાળવાયેલ આવાસનું સ્ટેમ્પ ડ્યુટી રજિસ્ટ્રેશન રૂ.૧૦૦/-ના સ્ટેમ્પ પેપર ઉપર કરવાનું રહેશે.
- ૪.૮ પાત્ર લાભાર્થી ઝૂંપડપટ્ટીમાં દુકાન ધરાવતા હશે તો પુનઃવસન યોજના અંતર્ગત લઘુત્તમ ૧૫ ચો.મી. ધરાવતી દુકાન મેળવવા તેઓ પાત્ર બનશે.
૫. જાહેર જમીનો પર આવેલ ઝૂંપડપટ્ટીનું પુનઃવસન કરવા જાહેર ખાનગી ભાગીદારીથી કરવામાં આવશે તેમજ ઝૂંપડપટ્ટી પુનઃવસન માટે આવી જાહેર ખાનગી ભાગીદારી આ નીતિનું મુખ્ય કેન્દ્રબિંદુ છે.
- ૫.૧ જાહેર સંસ્થાઓ તેમજ ખાનગી વિકાસકારોના કાર્યો અને ફરજો.
- ૫.૧.૧ રાજ્યકક્ષાની ઝૂંપડપટ્ટીના પુનઃવસન માટેની નિયત સત્તા મંડળ ધ્વારા નીચે મુજબની કામગીરી કરવામાં આવશે.
- (અ) આ સત્તા મંડળ ધ્વારા નિયમનકર્તા, મદદકર્તા અને સંભવકર્તા તરીકે કામગીરી કરવામાં આવશે.

- (બ) આ નીતિના અમલ માટે જરૂરી સંસ્થાગત માળખાનું ઘડતર કરવું.
- (ક) આ નીતિનું અર્થઘટન તેમજ અમલીકરણમાં પડતી મુશ્કેલીઓના નિવારણ માટેની કામગીરી કરવી.
- (ડ) આ નીતિ અંતર્ગત ઝૂંપડપટ્ટી પુનઃવસનનું આયોજન તેમજ દેખરેખની કામગીરી કરવી.

પ.૧.૨ નિયત સત્તા મંડળના કાર્યો અને ફરજો નીચે મુજબના રહેશે.

- (અ) ઝૂંપડપટ્ટીના તે જ સ્થળે પુનઃવસનની યોજના બનાવવી.
- (બ) ઝૂંપડપટ્ટીમાં ૧/૧૨/૨૦૧૦ની સ્થિતિએ રહેતા કુટુંબોની યાદી બનાવવી.
- (ક) આ યોજનાના માર્ગદર્શક માપદંડો નિયત કરવા.
- (ડ) જાહેર અને પારદર્શક બીડીંગ પદ્ધતિથી ખાનગી વિકાસકારોનું ચયન કરવું.
- (ઘ) જરૂરી કાયદાકીય (સ્ટેચ્યુટરી કલિઅરન્સ) મંજૂરી આપવી.
- (ઙ) ઝૂંપડપટ્ટીનું તે જ સ્થળે પુનઃવસન માટે જગ્યા ખાલી કરવા ખાનગી વિકાસકારોને મદદરૂપ થવું.
- (ગ) પાયાની જરૂરિયાતો માટે મુખ્ય બાહ્ય આંતરમાળખાકીય સુવિધાઓ ઉપલબ્ધ કરાવવી.
- (ઘ) ખાનગી વિકાસકાર સાથે ઝૂંપડપટ્ટી પુનઃવસન યોજના માટે, કન્સેશન એગ્રીમેન્ટ કરવું. આ એગ્રીમેન્ટમાં ખાનગી વિકાસકારને આપવામાં આવનાર પ્રોત્સાહનો, છૂટછાટ અને બંને પક્ષના કાર્યો અને ફરજો આવરી લેવાના રહેશે. આ ઉપરાંત આમુખમાં દર્શાવેલ કોઈ પણ ધ્યેય સિધ્ધિનો ભંગ થયેથી નિયત પ્રક્રિયા મુજબ એગ્રીમેન્ટ રદ કરવાની જોગવાઈ પણ રાખવાની રહેશે.

પ.૧.૩ ખાનગી વિકાસકારોના કાર્યો અને ફરજો.

- પ.૧.૩.૧ ઝૂંપડપટ્ટી પુનઃવસન યોજના માટેના વિગતવાર આર્કિટેકચરલ તેમજ સ્ટ્રક્ચરલ ડ્રોઇંગ અને ડીઝાઇન તેમજ આવાસની ડીઝાઇન અને યોજનાનું માળખું તૈયાર કરવું.
- પ.૧.૩.૨ ઝૂંપડપટ્ટી પુનઃવસન માટે જરૂરી નાણાકીય ભંડોળની વ્યવસ્થા કરવી.
- પ.૧.૩.૩ ઝૂંપડપટ્ટી પુનઃવસન યોજનાની મંજૂરી જરૂરી નિયત સત્તાધિકારી પાસેથી મેળવવી.
- પ.૧.૩.૪ ઝૂંપડપટ્ટીનું તે જ સ્થળે પુનર્વસન કરવા સ્થળ ખાલી કરાવવું.
- પ.૧.૩.૫ ઝૂંપડપટ્ટી પુનઃવસનની મંજૂર થયેલ યોજનાના અમલીકરણ દરમ્યાન આ યોજનાના લાભાર્થીઓને અન્ય સ્થળે રહેવાની વ્યવસ્થા કરવા તેમજ યોજના પૂર્ણ

થયેથી તેઓને તે જ સ્થળે યોજના અંતર્ગત ફાળવવામાં આવેલ આવાસોમાં વસાવવાના રહેશે.

- ૫.૧.૩.૬ ઝૂંપડપટ્ટી પુનઃ વિકાસ કરવાની જવાબદારી ખાનગી વિકાસકારની રહેશે.
- ૫.૧.૩.૭ ઝૂંપડપટ્ટી પુનઃવસન યોજના અંતર્ગત બનાવવામાં આવેલ આવાસોની નિયત સત્તા મંડળની દેખરેખ અંતર્ગત લાભાર્થીઓની ઉપસ્થિતિમાં કોમ્પ્યુટર ડ્રો કરી ફાળવણી કરવી.
- ૫.૧.૩.૮ લાભાર્થીઓને આવાસ ઉપરાંત યોજના અંતર્ગત પાયાની સુવિધાઓ પૂરી પાડવી.
- ૫.૧.૩.૯ યોજનાના લાભાર્થીઓનું યોજનાની જાળવણી માટે એસોસિએશન બનાવવું.
- ૫.૧.૩.૧૦ યોજનાની જાળવણી માટે બાંધકામના પ્રતિ ચો.મી. રૂ. ૨૫૦/-નું ભંડોળ ઉભું કરી લાભાર્થીઓના એસોસિએશનને અથવા નિયત સત્તામંડળને તબદીલ કરવું.
- ૫.૧.૩.૧૧ ઝૂંપડપટ્ટી પુનઃવસન યોજના માટે પસંદગી કરવામાં આવેલ વિકાસકારની defect liability period ૭ વર્ષનો રહેશે.

૬. નિયત સત્તા મંડળ ધ્વારા ખાનગી વિકાસકારને નીચે મુજબના પ્રોત્સાહન આપવામાં આવશે.
- ૬.૧ ઝૂંપડપટ્ટી પુનઃવસન માટેની જમીન પર ફક્ત વિકાસ કરવાના હેતુસર મહત્તમ ૩ FSI આપવામાં આવશે.
- ૬.૨ જો ઝૂંપડપટ્ટીનું તે જ સ્થળે પુનઃવસન કર્યા બાદ ખાલી જમીન બચે તો તે ખાનગી વિકાસકાર ખાલી જમીન પર ફી સેલ માટે હયાત નિયમાનુસાર વિકાસ કરી શકશે.
- ૬.૩ ખાનગી વિકાસકારને ઝૂંપડપટ્ટીની જમીન પર નીચે મુજબના બે હકકો આપવામાં આવશે.
- (૧) આ નીતિ અંતર્ગત નિયત કરેલ વિકાસના હકકો
- (૨) ઝૂંપડપટ્ટી પુનઃવસન કર્યા બાદ જે જમીન ખાલી પડે તેને પોતાના નફા માટે વિકાસ કરવા ફી હોલ્ડ હકકો.
- ૬.૪ ફક્ત ઝૂંપડપટ્ટી પુનઃવસન માટે લાગુ પડતા મ્યુનિસિપલ તેમજ મહેસુલી ચાર્જીસમાંથી ખાનગી વિકાસકારને મુક્તિ આપવામાં આવશે, પરંતુ ઝૂંપડપટ્ટી પુનઃવસન બાદ બાકી રહેતી જમીન પર પોતાના નફા માટે કરવામાં આવેલ વિકાસ માટે લાગુ પડતા બધા જ મ્યુનિસિપલ તેમજ મહેસુલી ચાર્જીસ ખાનગી વિકાસકાર ધ્વારા ભરવાના રહેશે.
- ૬.૫ ફક્ત ઝૂંપડપટ્ટીના તે જ સ્થળ પુનઃવસન માટે બાંધકામ માટેના પેટા નિયમોમાં આપવામાં આવેલ છુટછાટ રીસ્ટ્રિક્ટેડ વિસ્તાર સિવાયના દરેક વિસ્તારમાં લાગુ પડશે.

૭. નિયત સત્તા મંડળ ધ્વારા ખાનગી વિકાસકારોની પસંદગી નીચે દર્શાવ્યા મુજબની જાહેર અને પારદર્શક પદ્ધતિથી કરવામાં આવશે.
- ૭.૧ ખાનગી વિકાસકારોની પસંદગી જાહેર અને પારદર્શક ટેન્ડર પદ્ધતિ ધ્વારા કરવામાં આવશે અને આ માટેનું મોડલ ટેન્ડર રાજ્ય કક્ષાની સત્તા મંડળ ધ્વારા આપવામાં આવશે.
- ૭.૨ પ્રચલિત બે બીડ પદ્ધતિ મુજબ ઝૂંપડપટ્ટી પુનઃવસન કરવા ઇચ્છુક વિકાસકારોનો નિયત તાંત્રીક માપદંડ અનુસાર તારવવામાં આવશે. તાંત્રીક માપદંડ મુજબ તારવેલ ખાનગી વિકાસકારો પાસેથી ઝૂંપડપટ્ટી પુનઃવસન યોજના માટેની કિંમત મેળવવામાં આવશે. જે ખાનગી વિકાસકાર સૌથી ઓછી કિંમતની બોલી રજુ કરે તેની પસંદગી આખરી કરવામાં આવશે. નિયત સત્તા મંડળ ધ્વારા આ કિંમતની ભરપાઇ તબદીલીપાત્ર વિકાસના હકકો ધ્વારા કરવામાં આવશે.
- ૭.૩ ખાનગી વિકાસકારો ધ્વારા નાણાકીય બીડ નીચે મુજબ આપવામાં આવશે.
 - ૭.૩.૧. પ્રથમ ઝૂંપડપટ્ટી પુનઃવસનની સંપૂર્ણ યોજના માટેની ફૂલ કિંમતની વિકાસકારો ધ્વારા ગણતરી કરવામાં આવશે. જેમાં બાંધકામની કિંમત, ટ્રાન્ઝીટ એકોમોડેશનમાં થનાર ખર્ચનો અંદાજ, અન્ય રીસ્ક ફેક્ટર ઉમેરીને થનાર ફૂલ ખર્ચની ગણતરી કરવામાં આવશે.
 - ૭.૩.૨. ઝૂંપડપટ્ટી પુનઃ વસન કર્યા બાદ જો કોઈ જમીન ખુલ્લી થવાનો વિકાસકારને અંદાજ હોય તો તે જમીનનો ઉપયોગ અથવા નિકાલ પોતાની રીતે કરી શકશે તે ધ્યાને લઈ પુનઃવસન માટે થનાર ફૂલ ખર્ચમાંથી તે જમીનની પોતાની અંદાજિત રકમ પોતાની રીતે બાદ કરી, ચોખ્ખી કેટલી રકમ પુનઃવસન માટે સત્તા મંડળને આપશે અથવા સત્તામંડળ પાસેથી મેળવવાની અપેક્ષા રાખે છે તે બીડીંગ માટેનો મુખ્ય કાઇટેરીયા રહેશે.
 - ૭.૩.૪. જે કિસ્સામાં પસંદ થયેલ વિકાસકારે નિયત સત્તા મંડળ પાસેથી રકમ લેવાની થાય તે કિસ્સામાં વિકાસકારની નિશ્ચિત થયેલ બીડની રકમની કિંમતના તબદીલીપાત્ર વિકાસના હકકો નિયત સત્તા મંડળ ધ્વારા આપવામાં આવશે.
- ૭.૪ પ્રોજેક્ટ મંજૂર થયેથી નિયત સત્તા મંડળ ધ્વારા ગુણવત્તા તપાસવા તટસ્થ નિરીક્ષક (કન્સલ્ટન્ટ)ની નિમણૂક કરવામાં આવશે.
- ૭.૫ ઝૂંપડપટ્ટી પુનઃવસન યોજના માટે હાલમાં ઉપયોગમાં લેવામાં આવતી ગુણવત્તાયુક્ત, ઝડપી, ટકાઉ અને જાળવણી અને નિભાવણીના ઓછા ખર્ચવાળા બાંધકામ મટીરીયલ/ટેકનોલોજીનો ઉપયોગ કરી શકાશે. આ માટે ટેકનોલોજી સંબંધિ સ્ટ્રક્ચરલ સ્ટેબીલીટી, મટીરીયલ ટેસ્ટીંગ તેમજ ઓકયુપન્સી માટેના જરૂરી પ્રમાણપત્ર મેળવવાના રહેશે અને સ્ટ્રક્ચરલ સેફ્ટી માટે

બાંધકામ પ્રવર્તમાન (Prevalent) GDCR મુજબ તેમજ મકાનની બાહ્ય દિવાલો નેશનલ બિલ્ડીંગ કોડ (NBC) મુજબ થાય તે જોવાનું રહેશે.

૮. તબદીલીપાત્ર વિકાસના હકકો.

૮.૧ તબદીલીપાત્ર વિકાસના હકકો એટલે એક જમીન પરથી વિકાસના હકકો બીજી જમીન પર તબદીલ/વેપાર/વેચાણ કરવાની મંજૂરી. આવા હકકો શહેરી સ્થાનિક સ્વરાજ્યની સંસ્થાઓ અથવા સત્તા મંડળ ધ્વારા સમય મર્યાદા તેમજ રકમ દર્શાવતા પ્રમાણપત્ર રૂપે આપવામાં આવશે. આવા હકકો બાંધકામના પેટા નિયમો અથવા રાજ્ય સરકાર ધ્વારા વખતોવખત આ સંબંધમાં કરવામાં આવેલ માર્ગદર્શક સૂચનાઓ મુજબ કરવામાં આવશે.

૮.૨ ઝૂંપડપટ્ટી પુનઃવસન યોજના માટે પસંદ થયેલ વિકાસકાર ધ્વારા ભરવામાં આવેલ કિંમત જેટલી કિંમતના તબદીલીપાત્ર વિકાસ હકકો નિયત સત્તા મંડળ ધ્વારા તે વિકાસકારોને આપવામાં આવશે. આવા તબદીલીપાત્ર હકકોનો ઉપયોગ “રીસ્ટ્રીક્ટેડ ઝોન” સિવાયના કોઈ પણ ઝોનમાં કરી શકાશે. જેમાં રાજ્યની હોટલો અને હોસ્પિટલો તેમજ ટાઉનશીપ પોલિસી અંતર્ગત મંજૂર થયેલ યોજનામાં તબદીલ કરી શકાશે.

૮.૩ વિકાસના હકકોની તબદીલી જે તે વિકાસ યોજનાના (Development Plan) વિસ્તાર અંતર્ગત કરી શકાશે.

૮.૪ જે પ્રાપ્તકર્તા જમીનો ૧૮ મીટર કે તેનાથી વધારે પહોળાઈ ધરાવતા રસ્તા પર આવેલ હોય તે જમીનો પર ૭૦ મીટરસુધીના બાંધકામની ઉંચાઈ મળવાપાત્ર થશે.

૮.૫ પેરા-૮.૪માં દર્શાવેલ બાંધકામની ઉંચાઈ મેળવવા તે ઝોનમાં મળવાપાત્ર મફત FSI ઉપરાંત જેટલી FSI ની જરૂર રહે તેટલી મર્યાદામાં તબદીલીપાત્ર વિકાસના હકકો પ્રાપ્તકર્તા જમીન પર તબદીલ કરી શકાશે.

૮.૬ પ્રાપ્તકર્તા જમીનના વિસ્તારમાં મળવાપાત્ર ચાર્જેબલ FSI ના દર સામે તબદીલીપાત્ર વિકાસ હકકો સરભર કરી શકાશે.

૮.૭ કુલ (મફત + ચાર્જેબલ) મળવાપાત્ર FSI થી વધારાની FSIની જરૂરિયાત પ્રાપ્તકર્તા જમીન પર રહે તો બાકી બચેલ તબદીલીપાત્ર વિકાસના હકકોની તબદીલી તે પ્રાપ્તકર્તા જમીનની પ્રવર્તમાન (Prevalent) જત્રી ભાવ પ્રમાણે પ્રો રેટા કરી શકાશે. આવી પ્રો રેટા તબદીલી માટે મૂળ TDRની યુનિટ વેલ્યુ = (મંજૂર બિડની કુલ રકમ / કુલ બાંધકામ) મુજબ ગણવાની રહેશે. વિકાસના હકકો તબદીલ કરવાના હેતુસરજે તે ઝૂંપડપટ્ટી પુનઃવસન

યોજના માટે ભરવામાં આવેલ ભાવોની તારીખના રોજની જત્રી કિંમત ફિઝ કરવામાં આવશે.

- ૮.૮ સામાન્યતઃ તબદીલીપાત્ર વિકાસના હકકોને સંપૂર્ણપણે અથવા ટુકડાઓમાં એક વાર તબદીલ કરી શકાશે.
- ૮.૯ આવા તબદીલીપાત્ર વિકાસના હકકો ઝૂંપડપટ્ટી પુનઃવસન યોજના માટે વર્ક ઓર્ડર આપ્યાની તારીખથી વધુમાં વધુ ૭ વર્ષમાં વાપરી લેવાના રહેશે.
- ૮.૧૦ તબદીલીપાત્ર વિકાસના હકકો ઝૂંપડપટ્ટી પુનઃવસન યોજના અંતર્ગત બાંધકામ પૂર્ણ થયેલ ૫૦ આવાસોના ગુણાંકના ભાગમાં આપી શકાશે. તબદીલીપાત્ર વિકાસ હકકોનો છેલ્લો ભાગ ઝૂંપડપટ્ટી પુનઃવસન યોજના પૂર્ણ થયાનું પ્રમાણપત્ર મળ્યેથી જ આપી શકાશે.
- ૮.૧૧ ઝૂંપડપટ્ટી પુનઃવસન યોજના પૂર્ણ થયેથી નિયત સત્તા મંડળ ધ્વારા યોજના પૂર્ણ થયાનું પ્રમાણપત્ર આપવામાં આવશે. આ પ્રમાણપત્ર ખાનગી વિકાસકારો ધ્વારા યોજનાના દરેક લાભાર્થીને આવાસ ફાળવી તેના રજીસ્ટ્રેશનદસ્તાવેજ રજૂ કર્યેથી તેમજ મકાન વપરાશનું પ્રમાણપત્ર રજૂ કર્યેથી આપવામાં આવશે.
- ૮.૧૨ તબદીલી પાત્ર વિકાસ હકકોની તબદીલી પર સ્ટેમ્પ ડયુટીમાંથી મુક્તિ આપવામાં આવશે.

૯. ઝૂંપડાવાસીઓની ભાગીદારી

- ૯.૧ પસંદ થયેલા વિકાસકાર ધ્વારા યોજનાનું અસરકારક આયોજન અને અમલીકરણ સુનિશ્ચિત કરવા માટે ઝૂંપડપટ્ટી પુનઃવસન યોજનાના અમલીકરણના દરેક તબક્કે ઝૂંપડપટ્ટીમાં વસતા સમુદાયોની ભાગીદારી સુનિશ્ચિત કરવામાં આવશે. વિકાસકાર ધ્વારા સરળ પુનઃવસન માટે ઝૂંપડપટ્ટીમાં વસતા કુટુંબોના સમુહોની વિકાસ પ્રક્રિયામાં ભાગીદારી વધે તે હેતુથી સ્વંયસેવી સંસ્થાઓ / કોમ્યુનીટી બેઝડ ઓર્ગેનાઇઝેશનની મદદ લઈ શકાશે. લોક ભાગીદારી નીચે મુજબ મેળવવાની રહેશે.
 - ૯.૧.૧. ઝૂંપડપટ્ટી પુનઃવસન યોજનાનું આયોજન કરવું, નકશાઓ તૈયાર કરવા, સર્વે, નામાંકન અને ડેટાબેઝ તૈયાર કરવામાં સહકાર મેળવવાનો રહેશે.
 - ૯.૧.૨. ઝૂંપડપટ્ટી પુનઃવસન યોજનાનું સુક્ષ્મ આયોજન તેઓના સહકારથી કરવાનું રહેશે.
 - ૯.૧.૩. ઝૂંપડપટ્ટી પુનઃવસન યોજનાના અમલીકરણ, મરામત અને જાળવણી ઝૂંપડપટ્ટી પુનઃવસન યોજના કક્ષાએ એસોસીએશન ગઠન કરી શકાશે.
 - ૯.૧.૪. ઝૂંપડપટ્ટી પુનઃવસનની યોજનામાં લાભાર્થીઓ જ્યારે તેમના નવા આવાસમાં નિવાસ માટે જાય ત્યારે શહેરી વ્યવસ્થામાં સુધરેલી અને જવાબદારીપૂર્ણ જીવનશૈલી અપનાવે તેની

કાળજી બિન સરકારી સંગઠનો / કોમ્યુનીટી બેઠઝ ઓર્ગેનાઇઝેશનની મદદ લઇ ખાનગી વિકાસકારે કરવાની રહેશે.

૧૦. આવાસોની ફાળવણી

- ૧૦.૧ નિયત સત્તામંડળની દેખરેખ હેઠળ પસંદ થયેલા વિકાસકારે ઝૂંપડપટ્ટી પુનઃવસન યોજના હેઠળ બનાવેલ મકાનોની ફાળવણી લાયકાત ધરાવતા ઝૂંપડપટ્ટી નિવાસીને તેમની ઉપસ્થિતિમાં કોમ્યુટરાઇઝડ ડ્રો ધ્વારા ફાળવવાના રહેશે.
- ૧૦.૨ ફાળવવામાં આવેલ આવાસનો માલિકી હકક યથાપ્રસંગે પત્નિ- પતિના સંયુક્ત નામે રહેશે અને તે મુજબ સ્ટેમ્પ ડ્યુટી રજીસ્ટ્રેશન અને પ્રોપર્ટી કાર્ડ નિભાવવામાં આવશે.
- ૧૦.૩ જમીનની માલિકી નિયત કરવામાં આવેલ સત્તામંડળ/ શહેરી સ્થાનિક સંસ્થાઓની જ રહેશે.
- ૧૦.૪ નિયત સત્તામંડળ ધ્વારા ઝૂંપડપટ્ટી પુનઃવસન યોજનાનું કામ પૂર્ણ થયાનું પ્રમાણપત્ર આપવામાં આવે ત્યારબાદ વિકાસકારે તેની મરામત અને જાળવણી અંગેની કામગીરી ઝૂંપડપટ્ટીમાં વસતા લોકોના સમૂહ / એસોસિએશનને અથવા નિયત સત્તામંડળને સોંપી દેવાની રહેશે.
૧૧. ઝૂંપડપટ્ટીનું તે જ સ્થળે પુનઃવસવાટની યોજના માટે બાંધકામના પેટા-નિયમોમાં નીચે મુજબ છૂટછાટ આપવામાં આવશે.
- ૧૧.૧ આવાસની લંબાઇ જરૂરિયાત મુજબ Expansion Joint સાથે સુસંગત રહેશે.
- ૧૧.૨ ઝૂંપડપટ્ટીના પુનઃવસન માટેની યોજનામાં માર્જીનની જગ્યા છોડીને બાકી જગ્યાનો યોજના માટે ઉપયોગ કરી શકાશે.
- ૧૧.૩ ઝૂંપડપટ્ટી પુનઃવસનના હેતુ માટે નીચે મુજબનો માર્જીન લાગુ પડશે.

રસ્તા પર આવેલા પ્લોટ માટે નીચે મુજબનો માર્જીન આપવામાં આવશે.

રસ્તાની પહોળાઇ	રસ્તા સાઇડ માર્જીન	બિલ્ડીંગની ઉંચાઇ	રસ્તાની સાઇડ સિવાયનું માર્જીન
૯ મીટર સુધી	૩.૦	૧૦.૦ મીટર સિલ્ટ સહિત	૨.૫ મીટર
૯ અને ૯ થી ૧૨ મીટર	૪.૫	૧૫.૦ મીટર સિલ્ટ સહિત	૩.૦ મીટર

૧૨ અને ૧૨ થી ૧૮ મીટર	૬.૦	૧૫ મીટર	૩.૦ મીટર
૧૮ અને ૧૮ થી ૩૦ મીટર	૭.૫	૧૫ થી ૨૫ મીટર	૪.૦ મીટર
૩૦ અને ૩૦ થી ૪૦ મીટર	૯.૦	૨૫ થી ૪૫ મીટર	૬.૦ મીટર
૪૦ અને ૪૦ મીટર થી વધુ	૧૨.૦૦	૪૫ થી ૭૦ મીટર	૮.૦ મીટર

- ૧૧.૪ કોમન પ્લોટ થી બિલ્ડિંગ સુધીના માર્જીનમાં છૂટછાટ આપવામાં આવશે. પ્રવર્તમાન નિયમો મુજબ ૨૫ મીટર, અને ૨૫ મીટર કરતા વધુ ઉંચાઇ ધરાવતા બિલ્ડિંગમાં ૩ મીટર અને ૬ મીટરનો માર્જીન જરૂરી છે. કેસના સંજોગોને ધ્યાનમાં લઈ, ૨૫ મીટર સુધીની ઉંચાઇ ધરાવતા બિલ્ડિંગો માટે ૨.૦૦ મીટરના માર્જીનની મંજૂરી આપવામાં આવશે.
- ૧૧.૫ (૧) ૩૦ Dwelling યુનિટ સુધી કોઈ લીફ્ટ રાખવાની રહેતી નથી. પરંતુ ૩૦ યુનિટ કરતાં યુનિટ વધે તો દર ૩૦ યુનિટ (Or Part) પ્રમાણે વધારાની લીફ્ટ રાખવાની રહેશે.
- (૨) ઉપરોક્ત (૧) સિવાય ૨૫ મીટર કરતાં બાંધકામની ઉંચાઇ વધે તો એક સિવાય વધારાની લીફ્ટ રાખવાની રહેશે.
- ૧૧.૬ લઘુત્તમ ૨૦૦ ચો.મી. અથવા બિલ્ડિંગ યુનિટનો ૮ ટકા વિસ્તાર બેમાંથી જે વધારે હોય તે કોમન પ્લોટ માટે ફાળવવાનો રહેશે.
- ૧૧.૭ ઝૂંપડપટ્ટી પુનઃવસનના પ્લોટ પર પુનઃવસન બાદ વધતી જમીન અલગ પ્લોટ તરીકે ગણી ઉપર નિયમાનુસાર સંબંધિત ઝોનમાં મળવાપાત્ર ઉંચાઇને બદલે પ્રવર્તમાન જી.ડી.સી.આર. મુજબ ૭૦ મીટર સુધીની ઉંચાઇને પ્રાપ્તકર્તા જમીન માટેની રોડની પહોળાઈ તેમજ માર્જીન જેવા પરિમાણો ધ્યાને લઈને મંજૂરી આપવામાં આવશે.
- ૧૧.૮ ૯.૦ મીટર કે તેનાથી ઓછી પહોળાઈના રસ્તા પર G + ૩ પ્રકારના મકાનો બનાવવાના રહેશે. ૯.૦ થી ૧૮.૦ મીટર પહોળાઈના રસ્તા પર G + ૫ પ્રકારના મકાનો, ૧૮.૦ મીટર થી વધુ પહોળા રસ્તા પર પ્રવર્તમાન (Prevalent) GDCR મુજબની ઉંચાઈવાળા મકાનો બનાવી શકાશે તેમાં લીફ્ટની મરામત અને નિભાવણીની જવાબદારી ૭ વર્ષ

સુધી જે તે વિકાસકારની રહેશે. ત્યારબાદ આ અંગેનું જરૂરી ભંડોળ સંબંધિત સ્થાનિક સ્વરાજ્યની સંસ્થામાં વિકાસકાર ધ્વારા જમા કરાવવાનું રહેશે.

૧૨. પ્રાપ્તકર્તા જમીન માટે બાંધકામના પેટા-નિયમોમાં નીચે મુજબ છૂટછાટ આપવામાં આવશે.
- ૧૨.૧ Restricted વિસ્તાર સિવાયના બધા જ વિસ્તારમાં વિકાસ હકકોની તબદીલીની મંજૂરી આપવામાં આવશે. વિકાસ હકકોની તબદીલી રાજ્ય સરકારની હોટલ એન્ડ હોસ્પિટલ પોલીસી તેમજ ટાઉનશીપ પોલીસી અંતર્ગત મંજૂર થયેલ દરખાસ્તોમાં પણ કરી શકાશે.
- ૧૨.૨ જો રસ્તાની પહોળાઈ ૧૮ મીટર અથવા વધુ હોય તો ૭૦ મીટર સુધીની બિલ્ડીંગની ઉંચાઈને મંજૂરી આપવામાં આવશે.
- ૧૨.૩ ગ્રાઉન્ડ કવરેજ:- માર્જીનની જગ્યા બાદ કર્યા બાદ પ્લોટનો વિસ્તાર માર્જીન- AUDA ના DP-2021 માં સૂચવેલ નિયમો મુજબના માર્જીન રાખવાના રહેશે.
- ૧૨.૪ રાજ્યના શહેરી વિસ્તારોમાં ઝૂંપડપટ્ટી પુનઃવસન, પુનઃવસન બાદ વધતી જમીન તેમજ પ્રાપ્તકર્તા જમીન પર ઔડાના ડેવલપમેન્ટ પ્લાન-૨૦૨૧ મુજબની ઉપર જણાવ્યા સિવાયની અન્ય જોગવાઈઓ લાગુ પડશે.

આ અંગે વિભાગની સરખા ક્રમાંકની ફાઇલ પર નાણા વિભાગની તા ૬/૭/૨૦૧૩ની નોંધથી મળેલ સમંતિ અન્વયે આ હુકમો કરવામાં આવે છે.

ગુજરાતના રાજ્યપાલશ્રીના નામે તથા તેમના હુકમથી

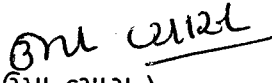
(ઉમા વ્યાસ)

સેક્શન અધિકારી

શહેરી વિકાસ અને શહેરી ગૃહનિર્માણ વિભાગ,

નકલ રવાના:

- માન. રાજ્યપાલશ્રીના અંગત સચિવશ્રી, (પત્ર ધ્વારા)
- માન. મુખ્ય મંત્રીશ્રીના સચિવશ્રી, સચિવાલય, ગાંધીનગર.
- માન. મંત્રીશ્રી(શ.વિ.)ના અંગત સચિવશ્રી, સચિવાલય, ગાંધીનગર
- માન. મંત્રીશ્રીઓ (તમામ) , સચિવાલય, ગાંધીનગર.

- અગ્ર સચિવશ્રી (ના.વિ.), ના અંગત સચિવશ્રી, સચિવાલય, ગાંધીનગર.
- અગ્ર સચિવશ્રી(શ.વિ.) ના અંગત સચિવશ્રી,શ.વિ. અને શ.ગૃ.નિ.વિ.,સચિવાલય, ગાંધીનગર
- અગ્ર સચિવશ્રી,સામાજીક ન્યાય અને અધિકારીતા વિભાગ, સચિવાલય, ગાંધીનગર
- અગ્ર સચિવશ્રી, આદિજાતિ વિકાસ વિભાગ, સચિવાલય, ગાંધીનગર.
- અધિક મુખ્ય કારોબારી અધિકારીશ્રીના અંગત સચિવશ્રી,જી.યુ.ડી.એમ. ગાંધીનગર.
- સચિવશ્રી(હાઉસીંગ)ના અંગત સચિવશ્રી શ.વિ. અને શ.ગૃ.નિ.વિ.,સચિવાલય, ગાંધીનગર.
- નાયબ સચિવશ્રી(હા.),શ.વિ. અને શ.ગૃ.નિ.વિ.,સચિવાલય,ગાંધીનગર
- ઉપ સચિવશ્રી (હા.) શ.વિ. અને શ.ગૃ.નિ.વિ.,સચિવાલય,ગાંધીનગર
- હાઉસીંગ કમિશ્નરશ્રી,ગુ.હા.બોર્ડ, અમદાવાદ
- મ્યુનિસિપલ કમિશ્નરશ્રી, મહાનગરપાલિકાઓ (તમામ)
- નિયામકશ્રી,નગરપાલિકાઓ, ગુજરાત રાજ્ય, ગાંધીનગર.
- અર્બન ડેવલપમેન્ટ ઓથોરીટી (તમામ)
- એરીયા ડેવલપમેન્ટ ઓથોરીટી (તમામ)
- ટીમ લીડર,જી.યુ.ડી.એમ., ગાંધીનગર.
- સીલેક્ટર ફાઇલ

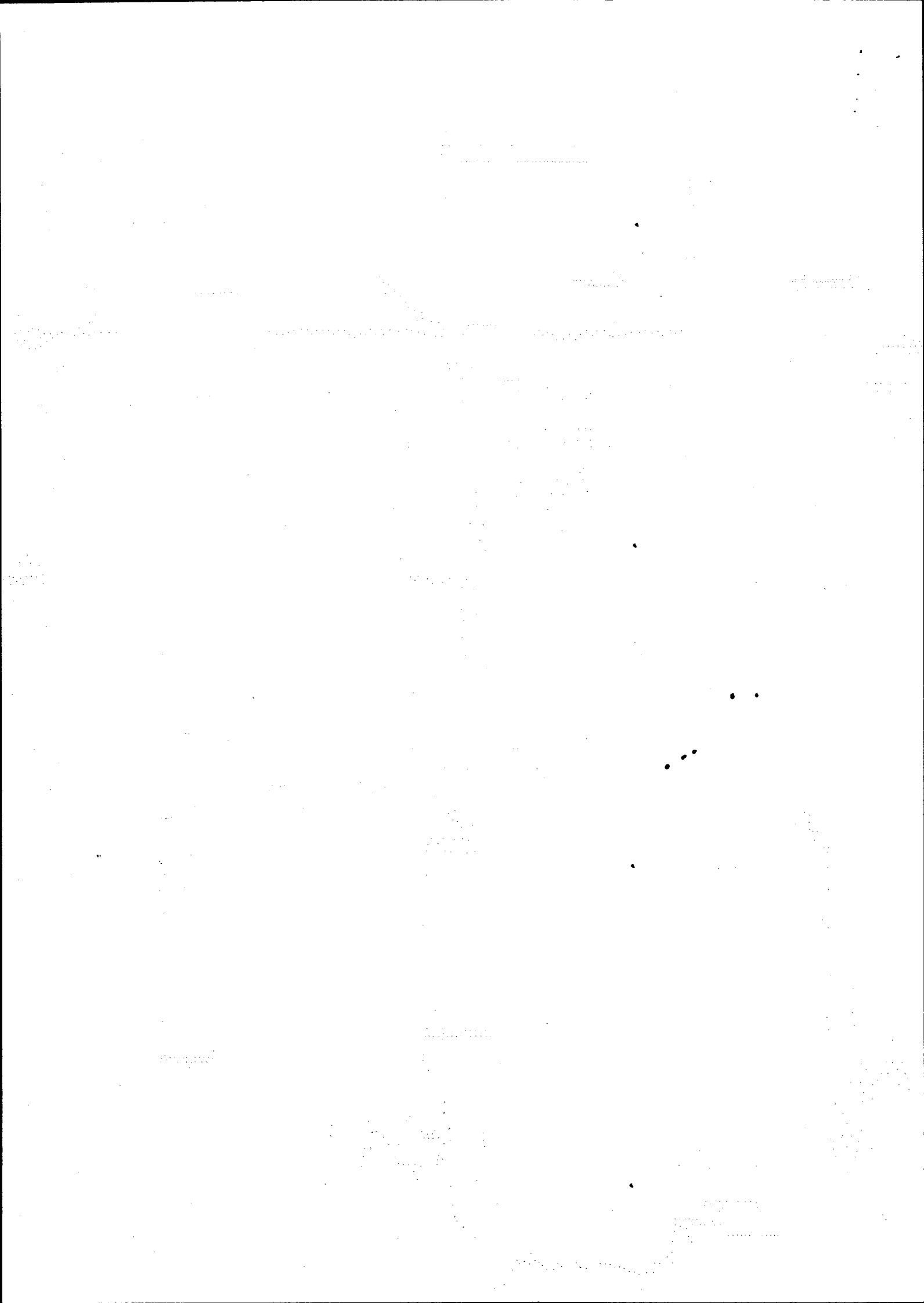

Planning Regulation for
Rehabilitation of Slums on Public
Land

ગુજરાત સરકાર

શહેરી વિકાસ અને શહેરી ગૃહનિર્માણ વિભાગ
બ્લોક નં. ૧૪, ૯ મો માળ, સચિવાલય, ગાંધીનગર.

હુકમ ક્રમાંક: ૪૫૬-૧૦૨૦૧૩-૩૦૯૧-૯

તા.૩૧.૦૭.૨૦૧૩

આમુખ:

રાજ્યમાં તા.૧૮.૦૭.૨૦૧૩ના રોજ મુખ્યમંત્રી આવાસ સમૃદ્ધિ યોજના અંતર્ગત જાહેર જમીનો પર આવેલ ઝુપડપટ્ટીઓનું PPP (પબ્લીક પ્રાઇવેટ પાર્ટનરશીપ) દ્વારા તે જ સ્થળે પુનઃ વસન કરવા માટેની નીતી જાહેર કરવામાં આવેલ છે. સદરહું નીતિ અન્વયે રાજ્યમાં અલગ-અલગ શહેરોમાં ગુજરાત નગર રચના અને શહેરી વિકાસ અધિનિયમ હેઠળ લાગુ થતાં જી.ડી.સી.આર.માં Planning Regulation for Rehabilitation of Slums on Public Land ના નિયમો તૈયાર કરવાની બાબત સરકારશ્રીની વિચારણાઈન હતી. સબબ બાબતે સરકારશ્રીની પુખ્ત વિચારણા અંતે નીચે મુજબનો હુકમ કરવામાં આવે છે.

હુકમ:

આથી ગુજરાત નગર રચના અને શહેરી વિકાસ અધિનિયમ, ૧૯૭૬ કલમ-૧૨૨ની પેટા કલમ-૧૨૨ની પેટા કલમ (૧) હેઠળ મળેલ સત્તાની રૂએ સરકાર 'Planning Regulation for Rehabilitation of Slums on Public Land'ને મંજૂર કરે છે. આ સાથે સામેલ સદર નિયમો તમામ સત્તામંડળોની મંજૂર/અમલી વિકાસ યોજનાના જી.ડી.સી.આર.માં સમાવેશ કરવા ગુજરાત નગર રચના અને શહેરી વિકાસ અધિનિયમ ૧૯૭૬ની કલમ-૧૯ હેઠળની કાયદાની નિયમોનુસારની દરખાસ્ત તુરંત જ રાજ્ય સરકારશ્રીને મોકલી આપવા અને જ્યાં સુધી કલમ-૧૯ હેઠળનો આવો ફેરફાર મંજૂર/અમલી ન બને ત્યાં સુધી ગુજરાત નગર રચના અને શહેરી વિકાસ અધિનિયમ ૧૯૭૬ની કલમ-૧૨૨ હેઠળ આ હુકમનો અમલ કરવા તમામ સમુચિત સત્તામંડળોને આથી, હુકમ કરવામાં આવે છે.

ગુજરાતના રાજ્યપાલશ્રીના હુકમથી અને તેમના નામે,

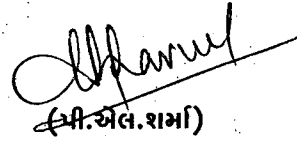

(શ્રી.એલ.શર્મા)

ખાસ ફરજ પરના અધિકારી અને સંયુક્ત સચિવ
શહેરી વિકાસ અને શહેરી ગૃહનિર્માણ વિભાગ

પ્રતિ,

- માન.મુખ્યમંત્રીશ્રીના સચિવશ્રી, માન.મુખ્યમંત્રીશ્રીનું કાર્યાલય, બ્લોક નં. ૧, ૫ મો માળ, સચિવાલય, ગાંધીનગર.
- સર્વે માન.મંત્રીશ્રીઓના અંગતસચિવશ્રી, સચિવાલય, ગાંધીનગર.
- મુખ્ય સચિવશ્રીના અંગત સચિવશ્રી, બ્લોક નં. ૧, ૪ થો માળ, સચિવલાય, ગાંધીનગર
- અગ્રસચિવશ્રીના રહસ્ય સચિવશ્રી, શહેરી વિકાસ અને શહેરી ગૃહનિર્માણ વિભાગ, સચિવાલય, ગાંધીનગર.
- સચિવાલયના તમામ વિભાગો
- મ્યુનિ.કમિશનરશ્રી, અમદાવાદ, વડોદરા, રાજકોટ, ભાવનગર, સુરત, જામનગર, જુનાગઢ.
- મુખ્ય કારોબારી અધિકારીશ્રી, તમામ શહેરી/વિસ્તાર વિકાસ સત્તામંડળ
- મુખ્ય કારોબારી અધિકારીશ્રી, મ્યુનિસિપલ ફાયનાન્સ બોર્ડ, ગાંધીનગર.
- સર્વે કલેક્ટરશ્રીઓ/સર્વે જિલ્લા વિકાસ અધિકારીશ્રીઓ
- નગર પાલિકા નિયામકશ્રી ગુજરાત રાજ્ય, ગાંધીનગર તરફે ટ્રેક નગરપાલિકાઓને જાણ કરવાની વિનંતી સહ.
- મુખ્ય નગર નિયોજકશ્રી, ગુજરાત રાજ્ય, ગાંધીનગર
- સીસ્ટમ મેનેજરશ્રી, શહેરી વિકાસ અને શહેરી ગૃહનિર્માણ વિભાગ, ગાંધીનગર તરફે વિભાગની વેબસાઈટ પર પ્રસિદ્ધિ અર્થે.
- વિભાગની તમામ શાખાઓ
- નાયબ સેક્શન અધિકારીશ્રીની સિલેક્ટ ફાઈલ (૨૦૧૩)
- લ-શાખા સિલેક્ટ ફાઈલ (૨૦૧૩)

Planning Regulation for Rehabilitation of Slums on Public Land

*(Notified for variation of GDCR vide order of the state government under
section 122, of TP Act, whereby the Development Authorities are directed
— to vary the GDCR)*

CONTENTS

1	Short Title, Extent and Commencement and Applicability:	4
2	Definitions	4
3	Planning Regulations for Slum Rehabilitation:	4
4	The Transfer of Development Rights (TDR).	7
5	Development for Non-Rehabilitation purposes	8
6	Notwithstanding anything contented in any GDCR:	8
7	Repeal and Saving	8

1 Short Title, Extent and Commencement and Applicability:

- (1) These regulations may be called "The Planning Regulation for Rehabilitation of Slums on Public Land"
- (2) These regulations shall be applicable within the jurisdiction of the appropriate authority constituted under Gujarat Town Planning & Urban Development Act 1976 and any municipality constituted under Gujarat Municipalities Act, 1963.
- (3) It shall come into force on such date as decided by order of the State Government.
- (4) These regulations shall apply to slums on the public lands/plots or part of lands/plots.

2 Definitions

- (1) "GDCR" means the general development control regulations made under clause (m) of sub-section (2) of section 12 of the Town Planning & Urban Development Act 1976;
- (2) "Notified Slums" means slum notified by the government in the official Gazette under section 3 of Gujarat Slum Area (Improvement, Clearance and Redevelopment), Act 1973.
- (3) "Public land" means any land owned by the urban local body or by the government or authority constituted under Gujarat Town Planning and Urban Development Act, 1976 or land owned by Gujarat Housing Board or Slum Clearance Board.
- (4) "Jantri" means annual statement of rates as declared by the Revenue Department as applicable on date on which the tender is advertise;

3 Planning Regulations for Slum Rehabilitation:

Notwithstanding anything content in the GDCR, the development permission for slum rehabilitation shall be regulated as per the following provisions:-

- (1) The minimum height of the plinth shall be 45 cms. from the top surface of approach road or path way.

- (2) The built-up area of any dwelling unit shall be minimum 25 Sq. mts.
- (3) The dwelling unit may include rooms, kitchen, bath, water closet and exclude common areas such as stairs, passages etc. used for the purpose of residence.
- (4) Permissible built-up area on any floor including the ground floor, shall be equivalent to the area of building unit left out after leaving margin.
- (5) For the layout, the width of approach road shall be as under:-

Length of road	Minimum width
1. Less than or equal to 75 mts	4.5
2. more than 75 mts and up to and including 150 mts	6.0
3. above 150 mts	As per GDCR

- (6) Minimum area of the common plot shall be at 8% of building unit. However no common plot shall be less than 200 sqmtr.

Note: To calculate the common plot requirements the area of a building unit used for the purpose of slum rehabilitation shall be considered.

- (7) 3.0 FSI shall be available for the land used for slum rehabilitation.
- (8) Height of the building shall be as under:

Road width in mts	Height of building in mts
upto 9.0	Maximum 13.5 mts [G+3]
above 9.0 & upto 18.0	Maximum 22.5 mts [G+3]
above 18.0	Maximum upto 70 mts

- (9) The competent authority may allow the building length to be more than 70 mts, only after ascertaining the safety with respect to fire.
- (10) Lift: lift shall be provided as per the following regulations:
 - (a) One lift has to be provided if the no of dwelling units exceed 30, and further for one additional lift has to be provided for every 30 units or part thereof;
 - (b) Notwithstanding anything contained in (a), one additional lift has to be provided if the building height exceeds 25 mts;
 - (c) The developer shall maintain the lifts for 7 years from the date of issue of building use permission and thereafter he shall, for the purpose of maintenance and upkeep, deposit with the appropriate

authority, a maintenance amount as decided by the competent authority.

(11) Margins for the building constructed for the rehabilitation shall be as under:

(a) Road side margins shall be as under:

Road width in mts	Road side Margin in mts
Up to 9	3.0
above 9 & upto 12	4.5
above 12 & upto 18	6.0
above 18 & upto 30	7.5
above 30 & upto 40	9.0
above 40	12.0

(b) Other than road side:

Building Height in mts	Margin other than road-side in mts
upto 10.	2.5
above 10 & upto 15	3.0
above 15 & upto 25	4.0
above 25 & upto 45	6.0
above 45 & upto 70	8.0

(c) 2.0 mts margins shall have to be kept on the side of common plot;

Provided that, in case of building for less than 25 mtrs height, the competent authority may, after making an inquiry and considering the merits of the case, reduce the margins. However the minimum margins shall not be less than 1.5 mtrs.

(12) Parking shall be provided as per GDCR subject to the following conditions:-

- (a) It has to be provided on the ground floor within the portion of ground coverage in the portion left after the non-residential use;
- (b) Portion of the required parking which could not be provided on the ground floor has to be provided either in basement or in the common plot. Maximum upto 50% of the common plot can be used for the purpose of parking. Parking provided in the common plot has to be kept open to sky.

(c) Parking layout and other rules for calculations etc shall be as per GDCR;

(13) Amenities and Scrutiny Fees shall be waived.

(14) The external walls shall be as per NBC and prevalent GDCR.

4 The Transfer of Development Rights (TDR).

- (1) Transfer of Development Rights (TDR) means making available certain amount of right of development, calculated in term of additional built up area, in lieu of the built-up area relinquished or surrendered or generated on account of slum rehabilitation by the owner of the land, so that he can use extra built up area either himself or transfer or sale or trade it to another person which the owner himself or any other person whom the built-up area is transfer or sold or traded can used as extra builtup area on any other building unit. (Note: the definition of owner for the purpose of TDR means the developer who is authorized for slum rehabilitation)
- (2) TDR can be used only within the area of the development plan wherein the slum rehabilitation has been done.
- (3) TDR shall be in addition to the builtup area permissible on a particular building unit.
- (4) TDR can be availed for any purpose on any plot located in any zone and on plots where the projects are approved under the Hotel & Hospital Regulations 2010.
- (5) TDR can be utilized in lieu of chargeable FSI.
- (6) The TDR can be availed only once. No further transfer shall be permitted. it can be released in parts also. However the TDR shall be permitted to be used within 7 years from the date of work order for slum rehabilitation.
- (7) The TDR shall be calculated as per clause 8.7 of resolution no PRC/102013/783/Th, dated 18.07.2013 for policy of in-situe rehabilitation of slums (Public Private Partnership) under the Mukhyamantri gruha (Gujarat Rural Urban Housing) Yogena.
- (8) The use of TDR shall be permitted only if it is consistent with the zone.

5 Development for Non-Rehabilitation purposes

- (1) The development for non-rehabilitation purposes shall be permitted on the portion of land left out after rehabilitation on the slum plot or on any other recipient plot where the slum TDR is permissible.
- (2) The GDCR, except for the provisions mentioned in these regulations shall be applicable.
- (3) Ground Coverage shall be equivalent to area left out after keeping margins.
- (4) Development in the plot left after the construction of the rehabilitation houses shall be permitted maximum upto 70.0 mts, if the plot has an approach from 18.0 mts or wider road.

6 Notwithstanding anything contented in any GDCR:

- (1) The use shall be permitted as per the zone.
Provided that slum rehabilitation shall be permitted in any zone other than restricted zone.
- (2) For non-slum rehabilitation purposes the regulations of AUDA shall apply mutatis mutandis except for the provisions made under these regulations.
- (3) Regulations, rules applicable under any law shall apply mutatis mutandis.
- (4) The TDR shall be calculated as under:-

7 Repeal and Saving

- (1) Those provisions the regulation for slum rehabilitation and re-development 2010 and the amendments there under which relate for the slum rehabilitation on public lands are repealed hereby.
- (2) relating to For the provisions
- (3) The decisions taken under the regulation for slum rehabilitation and re-development 2010 and the amendments therein shall be governed by these regulations. In case of any discrepancy arising on account of applicability of these regulations the decision of the State Government shall be final.

-----X-----

ગુજરાત સ્લમ રીહેબીલીટેશન પોલિસી
(PPP) ૨૦૧૩

ગુજરાત સરકાર
શહેરી વિકાસ અને શહેરી ગૃહનિર્માણ વિભાગ
ઠરાવ ક્રમાંક:-૫૨૫-૧૦ ૨૦૧૪-૩૪૯૩-થ
સચિવાલય, ગાંધીનગર.
તા.૧૫-૪-૨૦૧૫

વંચાણે લીધા:- શહેરી વિકાસ અને શહેરી ગૃહનિર્માણ વિભાગ, સચિવાલય, ગાંધીનગરનો તા.૧૮-૭-૨૦૧૩નો
ઠરાવ ક્રમાંક:પીઆરસી/૧૦૨૦૧૩/૭૮૩/થ.

આમુખ:

રાજ્યમાં તા.૧૮-૭-૨૦૧૩ના રોજ મુખ્યમંત્રી ગૃહ યોજના અંતર્ગત જાહેર જમીનો પર આવેલ
ઝૂંપડપટ્ટીઓનું PPP (પબ્લીક પ્રાઇવેટ પાર્ટનરશીપ) ધ્વારા તે જ સ્થળે પુનઃ વસન કરવા માટેની નીતિ જાહેર
કરવામાં આવેલ છે. સદરહુ નીતિ અન્વયે રાજ્યમાં અલગ અલગ શહેરોમાં ગુજરાત નગર રચના અને શહેરી
વિકાસ અધિનિયમ હેઠળ તા.૩૧-૭-૨૦૧૩ના રોજ Planning Regulation for Rehabilitation Slums on Public
Land પણ જાહેર કરવામાં આવેલ. આ અન્વયે ગુજરાત સ્લમ રીહેબીલીટેશન પોલિસી PPP ૨૦૧૩ નાં પેરા
૬.૧ બાબતે વિશેષ સ્પષ્ટતા કરવાની બાબત સરકારશ્રીની વિચારણાધીન હતી. આથી સરકારશ્રીની પૂખ્ત
વિચારણાને અંતે નીચે મુજબ ઠરાવવામાં આવે છે.

ઠ રા વ :-

આથી ગુજરાત સ્લમ રીહેબીલીટેશન પોલિસી, PPP ૨૦૧૩ના પેરા ૬.૧ પછી નીચે મુજબ પેરા ૬.૧.૧
વધુ સ્પષ્ટતા અર્થે ઉમેરવામાં આવે છે.

" મહત્તમ ૩ સુધી FSI આપવાના હેતુસર ગણતરી માટે જે જમીન પર ઝૂંપડપટ્ટી આવેલ હોય તે જમીનનો
સંપૂર્ણ વિસ્તાર ધ્યાને લેવામાં આવશે. આ ગણતરી મુજબ ઝૂંપડપટ્ટી પુનર્વસન માટે જરૂરી બાંધકામ બાદ
કરતાં બાકી બચેલી FSI ખાનગી વિકાસકાર ધ્વારા ફ્રી સેલ માટે વાપરી શકાશે."

ગુજરાતના રાજ્યપાલશ્રીના હુકમથી અને તેમના નામે,

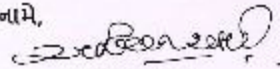
(એ. કે. શર્મા)

ઉપ સચિવ,

શહેરી વિકાસ અને શહેરી ગૃહનિર્માણ વિભાગ.

પાન નં..૨.ઉપર.....

21/4/15

નકલ રવાના:

- માન. રાજ્યપાલશ્રીના અંગત સચિવશ્રી, (પત્ર ધ્વારા)
- માન. મુખ્ય મંત્રીશ્રીના સચિવશ્રી, સચિવાલય, ગાંધીનગર.
- માન. રાજ્ય કક્ષાના મંત્રીશ્રી(શ.વિ.)ના અંગત સચિવશ્રી, સચિવાલય, ગાંધીનગર
- માન. મંત્રીશ્રીઓ (તમામ) , સચિવાલય, ગાંધીનગર.
- અધિક મુખ્ય સચિવશ્રી, મહેસુલ વિભાગ, સચિવાલય, ગાંધીનગર
- અગ્ર સચિવશ્રી (ના.વિ.), ના અંગત સચિવશ્રી, સચિવાલય, ગાંધીનગર.
- અગ્ર સચિવશ્રી(શ.વિ.) ના અંગત સચિવશ્રી, શ.વિ. અને શ.ગૃ.નિ.વિ., સચિવાલય, ગાંધીનગર
- અગ્ર સચિવશ્રી, સામાજિક ન્યાય અને અધિકારીતા વિભાગ, સચિવાલય, ગાંધીનગર
- અગ્ર સચિવશ્રી, આદિજાતિ વિકાસ વિભાગ, સચિવાલય, ગાંધીનગર.
- ✓ અધિક મુખ્ય કારોબારી અધિકારીશ્રીના અંગત સચિવશ્રી, જી.યુ.ડી.એમ. ગાંધીનગર.
- સચિવશ્રી(હાઉસીંગ)ના અંગત સચિવશ્રી શ.વિ. અને શ.ગૃ.નિ.વિ., સચિવાલય, ગાંધીનગર.
- નાયબ સચિવશ્રી(હા.), શ.વિ. અને શ.ગૃ.નિ.વિ., સચિવાલય, ગાંધીનગર
- ઉપ સચિવશ્રી (હા.) શ.વિ. અને શ.ગૃ.નિ.વિ., સચિવાલય, ગાંધીનગર
- હાઉસીંગ કમિશ્નરશ્રી, ગુ.હા.બોર્ડ, અમદાવાદ
- મ્યુનિસિપલ કમિશ્નરશ્રી, મહાનગરપાલિકાઓ (તમામ)
- જીલ્લા કલેક્ટરશ્રીઓ (તમામ)
- નિયામકશ્રી, નગરપાલિકાઓ, ગુજરાત રાજ્ય, ગાંધીનગર.
- અર્બન ડેવલપમેન્ટ ઓથોરીટી (તમામ)
- એરીયા ડેવલપમેન્ટ ઓથોરીટી (તમામ)
- ટીમ લીડર, જી.યુ.ડી.એમ., ગાંધીનગર.
- સીલેક્ટર ફાઇલ

ગુજરાત સ્લમ રીહેબીલીટેશન પોલિસી (PPP) ૨૦૧૩

ગુજરાત સરકાર
શહેરી વિકાસ અને શહેરી ગૃહનિર્માણ વિભાગ
પરિપત્ર ક્રમાંક:-પરચ-૧૦-૨૦૧૪-૩૪૯૩-થ
સચિવાલય, ગાંધીનગર.
તા.૨૩/૦૪/૨૦૧૫

વંચાણે લીધા:- શહેરી વિકાસ અને શહેરી ગૃહનિર્માણ વિભાગ, સચિવાલય, ગાંધીનગરનો તા.૧૮-૭-૨૦૧૩નો ઠરાવ ક્રમાંક:પીઆરસી/૧૦૨૦૧૩/૭૮૩/થ.

પરિપત્ર

રાજ્યમાં તા.૧૮-૦૭-૨૦૧૩ના રોજ મુખ્યમંત્રી ગૃહ યોજના અંતર્ગત જાહેર જમીનો પર આવેલ ઝૂંપડપટ્ટીઓનું PPP (પબ્લીક પ્રાઇવેટ પાર્ટનરશીપ) ધ્વારા તે જ સ્થળે પુનઃ વસન કરવા માટેની નીતિ જાહેર કરવામાં આવેલ છે. સદરહુ નીતિ અન્વયે રાજ્યમાં અલગ અલગ શહેરોમાં ગુજરાત નગર રચના અને શહેરી વિકાસ અધિનિયમ હેઠળ તા.૩૧-૭-૨૦૧૩ના રોજ Planning Regulation for Rehabilitation Slums on Public Land પણ જાહેર કરવામાં આવેલ છે. ગુજરાત સ્લમ રીહેબીલીટેશન પોલિસી PPP ૨૦૧૩ અન્વયે આથી નીચે મુજબની સૂચનાઓ પરિપત્રિત કરવામાં આવે છે.

(૧) ગુજરાત સ્લમ રીહેબીલીટેશન પીપીપી પોલિસી ૨૦૧૩ અંતર્ગત ઝૂંપડપટ્ટીની આખી જમીન પર મફત ૩ FSI આપવામાં આવે છે. આ જમીન પર ૩ FSI અને સ્લમ રેગ્યુલેશન્સ ૨૦૧૩ મુજબ સ્લમ રીહેબીલીટેશન અને ત્યાર બાદ બચતી FSI free sale માટે વાપરવાની રહેશે. આ રીતે Free sale માટે મળતી FSI ધ્યાને રાખીને ડેવલપર ધ્વારા નીચે મુજબની બે બાબતો ધ્યાને રાખીને બીડીંગ કરવાનું રહેશે.

(અ) સ્લમ રીહેબીલીટેશનની કોસ્ટ :- આ કોસ્ટમાં ડેવલપર ધ્વારા બાંધકામ, ટ્રાન્ઝીટ એકોમોડેશન, રીસ્ક ફેક્ટર તેમજ તેઓના રીઝનેબલ પ્રોફીટની ગણતરી ધ્યાને લેવાની રહેશે.

(બ) લેન્ડ પ્રીમીયમ :- આ માટે ડેવલપર ધ્વારા ઝૂંપડપટ્ટીની આખી જમીન પર ૩ FSI પ્રમાણે મળતા બાંધકામમાંથી સ્લમ રીહેબીલીટેશનના બાંધકામ બાદ કયાં પછી બચતી FSI માંથી મળતું પોતાના માટેનું બાંધકામ અને તેની વેચાણ કીંમત ધ્યાને લઈ, પ્રીમીયમ કલોટ કરવાનું રહેશે.

ઉપર (અ) અને (બ) મુજબ ગણતરી કરતાં જે કિસ્સાઓમાં SRS ની કોસ્ટ વધારે હોય ફક્ત તે જ કિસ્સાઓમાં તફાવતની રકમ જેટલા TDR ઇસ્યુ કરવામાં આવશે.

(૨) સ્લમ રીહેબીલીટેશનના પ્લાનીંગ માટે નીચે મુજબના પ્લાનીંગ નોર્મ્સ પ્રાયોરીટી મુજબ ધ્યાને લેવાના રહેશે.

(અ) તારીખ:-૩૧૭-૨૦૧૩ના પ્લાનીંગ રેગ્યુલેશન ફોર રીહેબીલિટેશન ઓફ સ્લમ્સ ઓન પબ્લીક લેન્ડ

(બ) બાકીની પ્રક્રિયા માટે સ્લમ પોલિસી અને

(ક) (અ) અને (બ) સિવાય બાકીની બાબત માટે સ્થાનિક જીડીસીઆર.

(૩) ગુજરાત સ્લમ રીહેબીલિટેશન પોલીસી-૨૦૧૩ના પેરા ૮.૬ અને ૮.૭ મુજબ ડેવલપર્સને ટીડીઆર આપવામાં આવશે. પેરા ૧ (અ) અને (બ) સિવાયની અન્ય કોઈ બાબત TDR માટે ધ્યાને લેવામાં આવશે નહીં.

(૪) સ્લમ રેગ્યુલેશન્સ પ્રમાણે રોડની પહોળાઈ અનુસાર ફાયર ફાઇટરની મુવમેન્ટ અને ફાયર સેફ્ટી ધ્યાને લઈને સ્લમ રેગ્યુલેશન્સ મુજબ બીલ્ડિંગ હાઇટ મળવાપાત્ર રહેશે.

(૫) સ્લમ રેગ્યુલેશન્સ મુજબ રસ્તાની પહોળાઈ અને બીલ્ડિંગની હાઇટ ધ્યાને લઈ, મળવાપાત્ર માળ મુજબ બાંધકામ કરી શકાશે. જો સ્લમ રેગ્યુલેશનના મકાનોમાં નિયમાનુસાર લીફ્ટની જરૂરિયાત રહે તો ડેવલપર ધ્વારા લીફ્ટના મેઇનટેનન્સ માટે ડેવલપર્સની ૭ વર્ષની જવાબદારી રહેશે.

(૬) સ્લમ રીહેબીલિટેશન પોલિસી ૨૦૧૩ અંતર્ગત ડેવલપર ધ્વારા પેરા (૧)માં જણાવ્યા મુજબ બીડ કરી શકાય છે. Implementing agency ધ્વારા પણ દરેક સ્લમ રીહેબીલિટેશન પ્રોજેક્ટ માટે ઉપર પેરા (૧) ધ્યાને લઈ, ટેન્ડર પહેલાં કોસ્ટ અને પ્રીમીયમનું એસેસમેન્ટ કરવામાં આવશે અને ટેન્ડર પૂર્ણ થયા બાદ પેરા (૧)ના પરિબલો ધ્યાનમાં રાખી, રીઝનેબીલીટી ચેક કરવામાં આવશે. તે મુજબ ટેન્ડરની મંજૂરી કે નામંજૂરીની નિયત પ્રક્રિયા અનુસરવાની રહેશે.

(૭) સ્લમ રીહેબીલિટેશન પ્રોજેક્ટમાંથી જે લેન્ડ પ્રિમીયમ મળે તેને હાઉસિંગ ઇન્ફ્રાસ્ટ્રક્ચર ફંડમાં જમા લેવાનું રહેશે. આ આવકનો ઉપયોગ less viable અને non viable સ્લમના રીહેબીલિટેશન માટે અથવા એફોર્ડેબલ હાઉસિંગના પ્રોજેક્ટ માટે કરવાનો રહેશે. આ માટેનું આયોજન પ્રીસ્કાઇબ્ડ ઓથોરીટી ધ્વારા કરીને સ્ટેટ લેવલની પ્રીસ્કાઇબ્ડ ઓથોરીટી પાસે મોકલવાનું રહેશે.

સ્લમ રીહેબીલિટેશન પોલીસીના અમલ માટે ઉપર્યુક્ત સૂચનાઓનો ચૂસ્તપણે અમલ કરવાનો રહેશે.

ઉમા વ્યાસ
(ઉમા વ્યાસ)

સેક્શન અધિકારી

શહેરી વિકાસ અને શહેરી ગૃહનિર્માણ વિભાગ.

નકલ રવાના :-

- માનનીય મુખ્યમંત્રીશ્રીના સચિવશ્રી, સ્વર્ણિમ સંકુલ-૧, ગાંધીનગર.
- અંગત સચિવશ્રી, માન.રા.ક.મંત્રીશ્રી (શ.ગ.નિ.)નું કાર્યાલય, સ્વર્ણિમ સંકુલ-૨, ગાંધીનગર.

TYPICAL CROSS SECTION FOR C.C ROAD

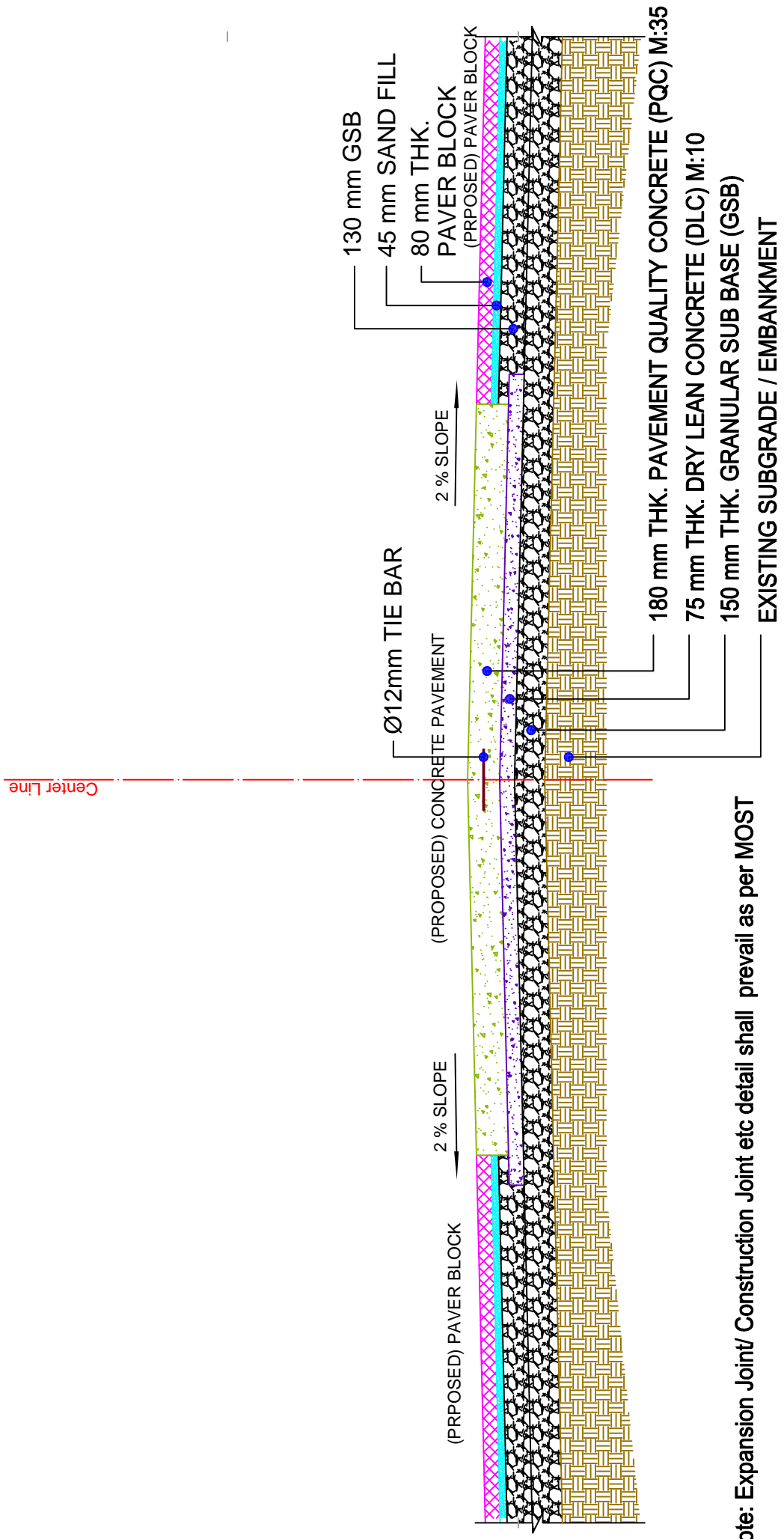

*Note: Expansion Joint/ Construction Joint etc detail shall prevail as per MOST

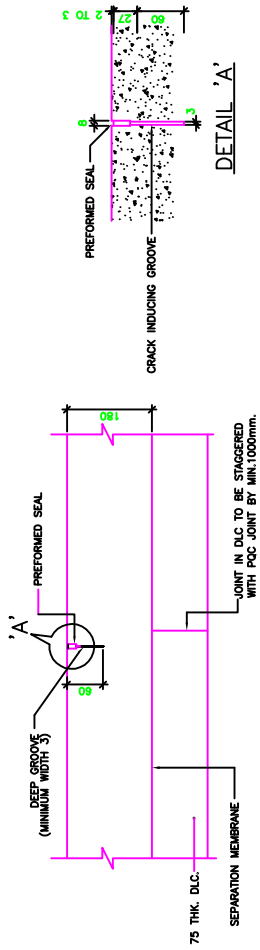

CONTRACTION JOINT WITH SAWN GROOVE

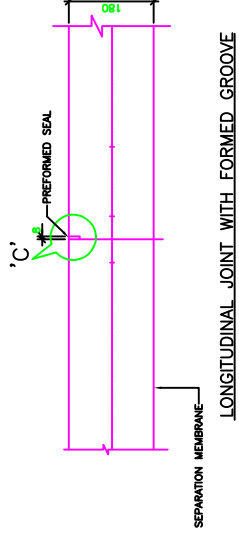

LONGITUDINAL JOINTS (BETWEEN TWO LANES)

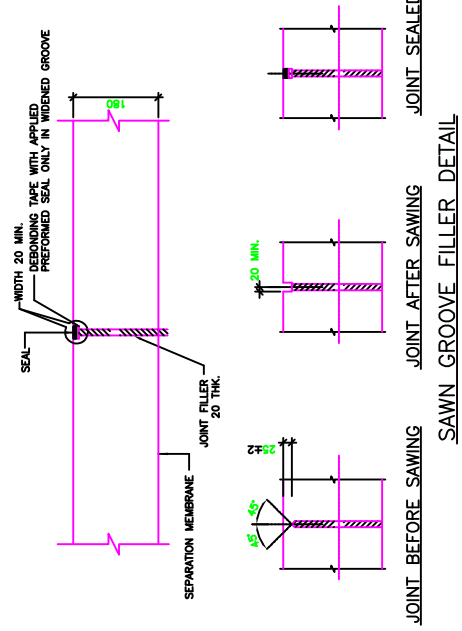
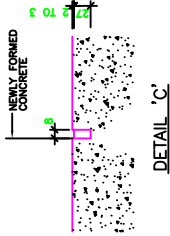

TRANSVERSE CONSTRUCTION JOINT/EXPANSION JOINT

NOTES:
1. ALL DIMENSIONS ARE IN MILLIMETRES.

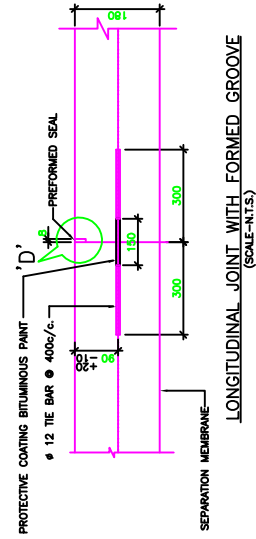

NOTES:
1. ALL DIMENSIONS ARE IN MILLIMETRES.

LONGITUDINAL JOINTS (BETWEEN TWO LANES)

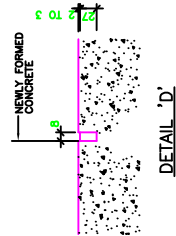

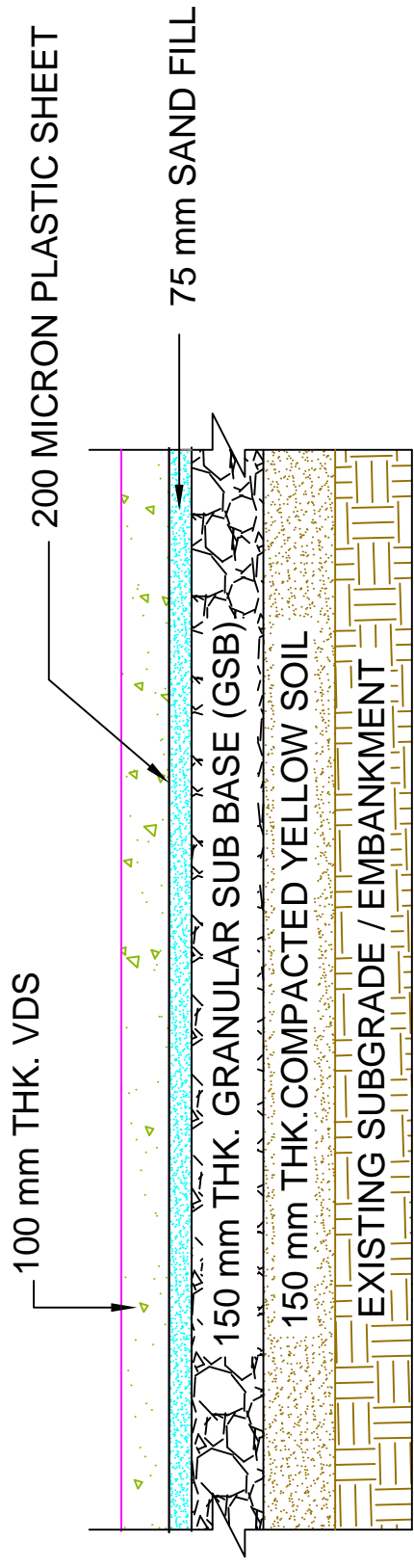

TYPICAL CROSS SECTION FOR VDS

NOTE:- AT EVERY 4.00 MTR 25MM GROVE

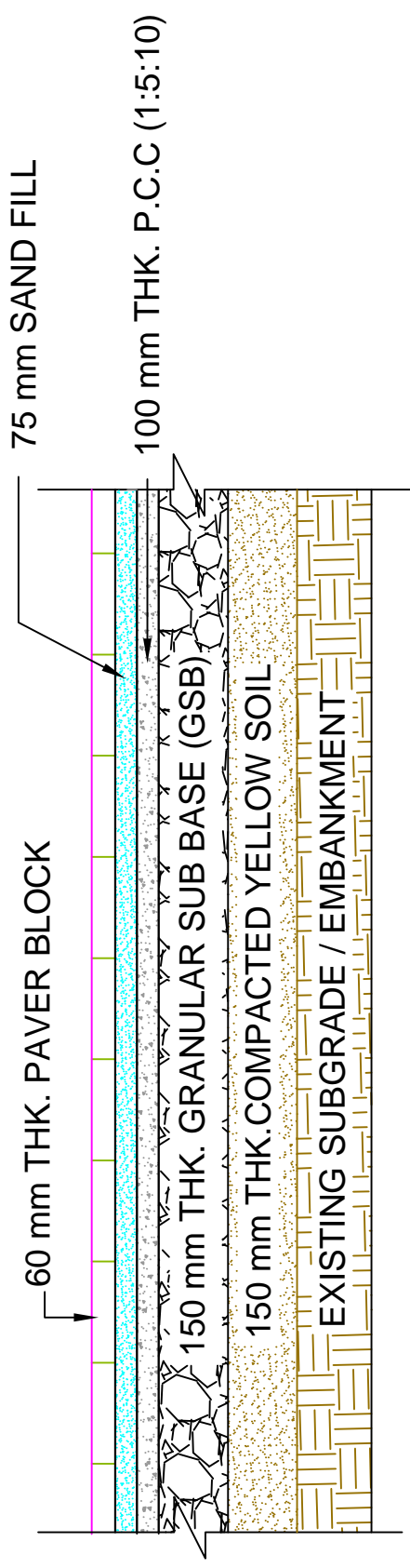

TYPICAL CROSS SECTION FOR PAVER BLOCK